

*Small. Fast. Reliable. Choose Any Three.*

*Using*

# SQLite



**O'REILLY®**

*Jay A. Kreibich*

# Using SQLite

Application developers, take note: databases aren't just for the IS group any more. You can build database-backed applications for the desktop, Web, embedded systems, or operating systems without linking to heavy-duty client-server databases such as Oracle and MySQL. This book shows you how to use SQLite, a small and lightweight relational database engine that you can build directly into your application.

With SQLite, you can develop a database-backed application that remains manageable both in size and complexity. This book guides you every step of the way. You'll get a crash course in data modeling, become familiar with SQLite's dialect of the SQL database language, and much more.

- Learn how to maintain localized storage in a single file that requires no configuration
- Build your own SQLite library or use a precompiled distribution in your application
- Get a primer on SQL, and learn how to use several language functions and extensions
- Work with SQLite using a scripting language or a C-based language such as C# or Objective-C
- Understand the basics of database design, and learn how to transfer what you already know to SQLite
- Take advantage of virtual tables and modules

*“Complex SQL concepts explained clearly.”*

—D. Richard Hipp  
creator of SQLite

Jay A. Kreibich is a professional software engineer who has always been interested in how people process and understand information. He currently works for Volition, Inc., a software studio that specializes in open-world video games.

*Previous programming experience is recommended.*

**O'REILLY**<sup>®</sup>  
oreilly.com

US \$49.99

CAN \$57.99

ISBN: 978-0-596-52118-9



**Safari**<sup>®</sup>  
Books Online

**Free online edition**

for 45 days with purchase of this book. Details on last page.

---

# Using SQLite



---

# Using SQLite

*Jay A. Kreibich*

O'REILLY®

Beijing • Cambridge • Farnham • Köln • Sebastopol • Taipei • Tokyo

## Using SQLite

by Jay A. Kreibich

Copyright © 2010 Jay A. Kreibich. All rights reserved.

Printed in the United States of America.

Published by O'Reilly Media, Inc., 1005 Gravenstein Highway North, Sebastopol, CA 95472.

O'Reilly books may be purchased for educational, business, or sales promotional use. Online editions are also available for most titles (<http://my.safaribooksonline.com>). For more information, contact our corporate/institutional sales department: (800) 998-9938 or [corporate@oreilly.com](mailto:corporate@oreilly.com).

**Editor:** Mike Loukides

**Production Editor:** Kristen Borg

**Proofreader:** Kiel Van Horn

**Indexer:** Lucie Haskins

**Cover Designer:** Karen Montgomery

**Interior Designer:** David Futato

**Illustrator:** Robert Romano

### Printing History:

August 2010: First Edition.

Nutshell Handbook, the Nutshell Handbook logo, and the O'Reilly logo are registered trademarks of O'Reilly Media, Inc. *Using SQLite*, the image of a great white heron, and related trade dress are trademarks of O'Reilly Media, Inc.

Many of the designations used by manufacturers and sellers to distinguish their products are claimed as trademarks. Where those designations appear in this book, and O'Reilly Media, Inc., was aware of a trademark claim, the designations have been printed in caps or initial caps.

While every precaution has been taken in the preparation of this book, the publisher and author assume no responsibility for errors or omissions, or for damages resulting from the use of the information contained herein.

ISBN: 978-0-596-52118-9

[M]

1281104401

*To my Great-Uncle Albert “Unken Al” Kreibich.*

*1918–1994*

*He took a young boy whose favorite question was  
“why?” and taught him to ask the question “how?”*

*(Who also—much to the dismay of his parents and  
the kitchen telephone—taught him the joy of  
answering that question, especially if it involved  
pliers or screwdrivers.)*

*—jk*





---

# Table of Contents

<b>Preface .....</b>	<b>xv</b>
<b>1. What Is SQLite? .....</b>	<b>1</b>
Self-Contained, No Server Required	2
Single File Database	4
Zero Configuration	4
Embedded Device Support	5
Unique Features	5
Compatible License	6
Highly Reliable	6
<b>2. Uses of SQLite .....</b>	<b>9</b>
Database Junior	9
Application Files	10
Application Cache	11
Archives and Data Stores	11
Client/Server Stand-in	11
Teaching Tool	12
Generic SQL Engine	13
Not the Best Choice	13
Big Name Users	15
<b>3. Building and Installing SQLite .....</b>	<b>17</b>
SQLite Products	17
Precompiled Distributions	18
Documentation Distribution	18
Source Distributions	19
The Amalgamation	19
Source Files	19
Source Downloads	20
Building	21

Configure	21
Manually	22
Build Customization	23
Build and Installation Options	23
An sqlite3 Primer	24
Summary	26
<b>4. The SQL Language .....</b>	<b>27</b>
Learning SQL	27
Brief Background	28
Declarative	28
Portability	29
General Syntax	30
Basic Syntax	30
Three-Valued Logic	31
Simple Operators	33
SQL Data Languages	34
Data Definition Language	34
Tables	35
Views	43
Indexes	44
Data Manipulation Language	45
Row Modification Commands	46
The Query Command	49
Transaction Control Language	51
ACID Transactions	51
SQL Transactions	53
Save-Points	55
System Catalogs	57
Wrap-up	58
<b>5. The SELECT Command .....</b>	<b>61</b>
SQL Tables	61
The SELECT Pipeline	62
FROM Clause	63
WHERE Clause	68
GROUP BY Clause	69
SELECT Header	70
HAVING Clause	73
DISTINCT Keyword	74
ORDER BY Clause	74
LIMIT and OFFSET Clauses	75
Advanced Techniques	76

Subqueries	76
Compound SELECT Statements	77
Alternate JOIN Notation	78
SELECT Examples	79
Simple SELECTs	80
Simple JOINs	80
JOIN...ON	81
JOIN...USING, NATURAL JOIN	82
OUTER JOIN	82
Compound JOIN	82
Self JOIN	83
WHERE Examples	83
GROUP BY Examples	84
ORDER BY Examples	85
What's Next	85
<b>6. Database Design .....</b>	<b>87</b>
Tables and Keys	87
Keys Define the Table	87
Foreign Keys	89
Foreign Key Constraints	90
Generic ID Keys	91
Keep It Specific	92
Common Structures and Relationships	93
One-to-One Relationships	93
One-to-Many Relationships	95
Many-to-Many Relationships	97
Hierarchies and Trees	99
Normal Form	102
Normalization	103
Denormalization	103
The First Normal Form	104
The Second Normal Form	104
The Third Normal Form	105
Higher Normal Forms	106
Indexes	107
How They Work	107
Must Be Diverse	108
INTEGER PRIMARY KEYs	109
Order Matters	109
One at a Time	110
Index Summary	111
Transferring Design Experience	112

Tables Are Types	112
Keys Are Backwards Pointers	113
Do One Thing	113
Closing	114
<b>7. C Programming Interface .....</b>	<b>115</b>
API Overview	115
Structure	116
Strings and Unicode	117
Error Codes	118
Structures and Allocations	118
More Info	119
Library Initialization	119
Database Connections	120
Opening	120
Special Cases	121
Closing	122
Example	122
Prepared Statements	123
Statement Life Cycle	123
Prepare	124
Step	126
Result Columns	127
Reset and Finalize	130
Statement Transitions	131
Examples	132
Bound Parameters	133
Parameter Tokens	133
Binding Values	135
Security and Performance	138
Example	140
Potential Pitfalls	141
Convenience Functions	142
Result Codes and Error Codes	146
Standard Codes	146
Extended Codes	148
Error Functions	148
Prepare v2	149
Transactions and Errors	150
Database Locking	151
Utility Functions	156
Version Management	156
Memory Management	157

Summary	158
<b>8. Additional Features and APIs</b> .....	<b>159</b>
Date and Time Features	159
Application Requirements	160
Representations	160
Time and Date Functions	162
ICU Internationalization Extension	167
Full-Text Search Module	169
Creating and Populating FTS Tables	169
Searching FTS Tables	170
More Details	171
R*Trees and Spatial Indexing Module	171
Scripting Languages and Other Interfaces	172
Perl	172
PHP	173
Python	173
Java	174
Tcl	174
ODBC	175
.NET	175
C++	175
Other Languages	176
Mobile and Embedded Development	176
Memory	176
Storage	177
Other Resources	178
iPhone Support	178
Other Environments	179
Additional Extensions	180
<b>9. SQL Functions and Extensions</b> .....	<b>181</b>
Scalar Functions	182
Registering Functions	182
Extracting Parameters	184
Returning Results and Errors	186
Example	189
Aggregate Functions	194
Defining Aggregates	194
Aggregate Context	195
Example	197
Collation Functions	200
Registering a Collation	201

Collation Example	202
SQLite Extensions	204
Extension Architecture	205
Extension Design	206
Example Extension: sql_trig	207
Building and Integrating Static Extensions	209
Using Loadable Extensions	211
Building Loadable Extensions	212
Loadable Extension Security	213
Loading Loadable Extensions	213
Multiple Entry Points	215
Chapter Summary	215
<b>10. Virtual Tables and Modules .....</b>	<b>217</b>
Introduction to Modules	218
Internal Modules	218
External Modules	218
Example Modules	219
SQL for Anything	219
Module API	220
Simple Example: dblist Module	224
Create and Connect	224
Disconnect and Destroy	229
Query Optimization	230
Custom Functions	231
Table Rename	232
Opening and Closing Table Cursors	233
Filtering Rows	235
Extracting and Returning Data	237
Virtual Table Modifications	239
Cursor Sequence	240
Transaction Control	241
Register the Module	243
Example Usage	245
Advanced Example: weblog Module	246
Create and Connect	248
Disconnect and Destroy	249
Other Table Functions	250
Open and Close	250
Filter	252
Rows and Columns	254
Register the Module	259
Example Usage	259

Best Index and Filter	262
Purpose and Need	262
xBestIndex()	263
xFilter()	266
Typical Usage	267
Wrap-Up	268
<b>A. SQLite Build Options .....</b>	<b>269</b>
<b>B. sqlite3 Command Reference .....</b>	<b>287</b>
<b>C. SQLite SQL Command Reference .....</b>	<b>299</b>
<b>D. SQLite SQL Expression Reference .....</b>	<b>341</b>
<b>E. SQLite SQL Function Reference .....</b>	<b>361</b>
<b>F. SQLite SQL PRAGMA Reference .....</b>	<b>381</b>
<b>G. SQLite C API Reference .....</b>	<b>409</b>
<b>Index .....</b>	<b>491</b>





---

# Preface

This book provides an introduction to the SQLite database product. SQLite is a zero-configuration, standalone, relational database engine that is designed to be embedded directly into an application. Database instances are self-contained within a single file, allowing easy transport and simple setup.

*Using SQLite* is primarily written for experienced software developers that have never had a particular need to learn about relational databases. For one reason or another, you now find yourself with a large data management task, and are hoping a product like SQLite may provide the answer. To help you out, the various chapters cover the SQL language, the SQLite C programming API, and the basics of relational database design, giving you everything you need to successfully integrate SQLite into your applications and development work.

The book is divided into two major sections. The first part is a traditional set of chapters that are primarily designed to be read in order. The first two chapters provide an in-depth look at exactly what SQLite provides and how it can be used. The third chapter covers downloading and building the library. Chapters Four and Five provide an introduction to the SQL language, while Chapter Six covers database design concepts. Chapter Seven covers the basics of the C API. Chapter Eight builds on that to cover more advanced topics, such as storing times and dates, using SQLite from scripting languages, and utilizing some of the more advanced extensions. Chapters Nine and Ten cover writing your own custom SQL functions, extensions, and modules.

To complete the picture, the ten chapters are followed by several reference appendixes. These references cover all of the SQL commands, expressions, and built-in functions supported by SQLite, as well as documentation for the complete SQLite API.

## SQLite Versions

The first edition of this book covers SQLite version 3.6.23.1. As this goes to press, work on SQLite version 3.7 is being finalized. SQLite 3.7 introduces a new transaction journal mode known as *Write Ahead Logging*, or WAL. In some environments, WAL can provide better concurrent transaction performance than the current rollback journal. This

performance comes at a cost, however. WAL has more restrictive operational requirements and requires more advanced support from the operating system.

Once WAL has been fully tested and released, look for an article on the O'Reilly website that covers this new feature and how to get the most out of it.

## Email Lists

The SQLite project maintains three mailing lists. If you're trying to learn more about SQLite, or have any questions that are not addressed in this book or in the project documentation, these are often a good place to start.

*sqlite-announce@sqlite.org*

This list is limited to announcements of new releases, critical bug alerts, and other significant events in the SQLite community. Traffic is extremely low, and most messages are posted by the SQLite development team.

*sqlite-users@sqlite.org*

This is the main support list for SQLite. It covers a broad range of topics, including SQL questions, programming questions, and questions about how the library works. This list is moderately busy.

*sqlite-dev@sqlite.org*

This list is for people working on the internal code of the SQLite library itself. If you have questions about how to use the published SQLite API, those questions belong on the *sqlite-users* list. Traffic on this list is fairly low.

You can find instructions on how to join these mailing lists on the SQLite website. Visit <http://www.sqlite.org/support.html> for more details.

The *sqlite-users@sqlite.org* email list can be quite helpful, but it is a moderately busy list. If you're only a casual user and don't wish to receive that much email, you can also access and search list messages through a web archive. Links to several different archives are available on the SQLite support page.

## Example Code Download

The code examples found in this book are available for download from the O'Reilly website. You can find a link to the examples on the book's catalog page at <http://oreilly.com/catalog/9780596521196/>. The files include both the SQL examples and the C examples found in later chapters.

## How We Got Here

Taking a book from an idea to a finished product involves a great many people. Although my name is on the cover, this could not have been possible without all of their help.

First, I would like to acknowledge the friendship and support of my primary editor, Mike Loukides. Thanks to some mutual friends, I first started doing technical reviews for Mike over eight years ago. Through the years, Mike gently encouraged me to take on my own project.

The first step on that path came nearly three years ago. I had downloaded a set of database exports from the Wikipedia project and was trying to devise a minimal database configuration that would (hopefully) cram nearly all the current data onto a small flash storage card. The end goal was to provide a local copy of the Wikipedia articles on an ebook reader I had. SQLite was a natural choice. At some point, frustrated with trying to understand the correct call sequence, I threw my hands up and exclaimed, “Someone should write a book about this!”—*Ding!*—The proverbial light bulb went off, and many, many (many...) late nights later, here we are.

Behind Mike stands the whole staff of O’Reilly Media. Everyone I interacted with did their best to help me out, calm me down, and fix my problems—sometimes all at once. The production staff understands how to make life easy for the author, so that we can focus on writing and leave the details to someone else.

I would like to thank D. Richard Hipp, the creator and lead maintainer of SQLite. In addition to coordinating the continued development of SQLite and providing us all with a high-quality software product, he was also gracious enough to answer numerous questions, as well as review a final draft of the manuscript. Some tricky spots went through several revisions, and he was always quick to review things and get back to me with additional comments.

A technical review was also done by Jon W. Marks. Jon is an old personal and professional friend with enterprise-class database experience. He has had the opportunity to mentor several experienced developers as they made their first journey into the relational database world. Jon provided very insightful feedback, and was able to pinpoint areas that are often difficult for beginners to grasp.

My final two technical reviewers were Jordan Hawker and Erin Moy. Although they are knowledgeable developers, they were relatively new to relational databases. As they went through the learning process, they kept me honest when I started to make too many assumptions, and kept me on track when I started to skip ahead too quickly.

I also owe a thank-you to Mike Kulas and all my coworkers at Volition, Inc. In addition to helping me find the right balance between my professional work and the book work, Mike helped me navigate our company's intellectual property policies, making sure everything was on the straight and narrow. Numerous coworkers also deserve a thank-you for reviewing small sections, looking at code, asking lots of good questions, and otherwise putting up with me venting about not having enough time in the day.

A tip of the hat goes out to the crew at the Aroma Café in downtown Champaign, Illinois. They're just a few blocks down from my workplace, and a significant portion of this book was written at their coffee shop. Many thanks to Michael and his staff, including Kim, Sara, Nichole, and Jerry, for always having a hot and creamy mocha ready.

Finally, I owe a tremendous debt to my wife, Debbie Fligor, and our two sons. They were always willing to make time for me to write and showed enormous amounts of patience and understanding. They all gave more than I had any right to ask, and this accomplishment is as much theirs as it is mine.

## Conventions Used in This Book

The following typographical conventions are used in this book:

### *Italic*

Indicates new terms, URLs, email addresses, filenames, and file extensions.

### Constant width

Used for program listings, as well as within paragraphs to refer to program elements such as variable or function names, databases, data types, environment variables, statements, and keywords.

### Constant width bold

Shows commands or other text that should be typed literally by the user.

### *Constant width italic*

Shows text that should be replaced with user-supplied values or by values determined by context.



This icon signifies a tip, suggestion, or general note.

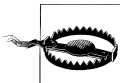

This icon indicates a warning or caution.

## Using Code Examples

This book is here to help you get your job done. In general, you may use the code in this book in your programs and documentation. You do not need to contact us for permission unless you're reproducing a significant portion of the code. For example, writing a program that uses several chunks of code from this book does not require permission. Selling or distributing a CD-ROM of examples from O'Reilly books does require permission. Answering a question by citing this book and quoting example code does not require permission. Incorporating a significant amount of example code from this book into your product's documentation does require permission.

We appreciate, but do not require, attribution. An attribution usually includes the title, author, publisher, and ISBN. For example: "*Using SQLite* by Jay A. Kreibich. Copyright 2010 O'Reilly Media, Inc., 978-0-596-52118-9."

If you feel your use of code examples falls outside fair use or the permission given above, feel free to contact us at [permissions@oreilly.com](mailto:permissions@oreilly.com).

## Safari® Books Online



Safari Books Online is an on-demand digital library that lets you easily search over 7,500 technology and creative reference books and videos to find the answers you need quickly.

With a subscription, you can read any page and watch any video from our library online. Read books on your cell phone and mobile devices. Access new titles before they are available for print, and get exclusive access to manuscripts in development and post feedback for the authors. Copy and paste code samples, organize your favorites, download chapters, bookmark key sections, create notes, print out pages, and benefit from tons of other time-saving features.

O'Reilly Media has uploaded this book to the Safari Books Online service. To have full digital access to this book and others on similar topics from O'Reilly and other publishers, sign up for free at <http://my.safaribooksonline.com>.

## How to Contact Us

Please address comments and questions concerning this book to the publisher:

O'Reilly Media, Inc.  
1005 Gravenstein Highway North  
Sebastopol, CA 95472  
800-998-9938 (in the United States or Canada)  
707-829-0515 (international or local)  
707 829-0104 (fax)

We have a web page for this book, where we list errata, examples, and any additional information. You can access this page at:

<http://oreilly.com/catalog/9780596521196/>

To comment or ask technical questions about this book, send email to:

[bookquestions@oreilly.com](mailto:bookquestions@oreilly.com)

For more information about our books, conferences, Resource Centers, and the O'Reilly Network, see our web site at:

<http://www.oreilly.com>

# What Is SQLite?

In the simplest terms, SQLite is a public-domain software package that provides a *relational database management system*, or RDBMS. Relational database systems are used to store user-defined records in large tables. In addition to data storage and management, a database engine can process complex query commands that combine data from multiple tables to generate reports and data summaries. Other popular RDBMS products include Oracle Database, IBM's DB2, and Microsoft's SQL Server on the commercial side, with MySQL and PostgreSQL being popular open source products.

The "Lite" in SQLite does not refer to its capabilities. Rather, SQLite is lightweight when it comes to setup complexity, administrative overhead, and resource usage. SQLite is defined by the following features:

### *Serverless*

SQLite does not require a separate server process or system to operate. The SQLite library accesses its storage files directly.

### *Zero Configuration*

No server means no setup. Creating an SQLite database instance is as easy as opening a file.

### *Cross-Platform*

The entire database instance resides in a single cross-platform file, requiring no administration.

### *Self-Contained*

A single library contains the entire database system, which integrates directly into a host application.

### *Small Runtime Footprint*

The default build is less than a megabyte of code and requires only a few megabytes of memory. With some adjustments, both the library size and memory use can be significantly reduced.

### *Transactional*

SQLite transactions are fully ACID-compliant, allowing safe access from multiple processes or threads.

### *Full-Featured*

SQLite supports most of the query language features found in the SQL92 (SQL2) standard.

### *Highly Reliable*

The SQLite development team takes code testing and verification very seriously.

Overall, SQLite provides a very functional and flexible relational database environment that consumes minimal resources and creates minimal hassle for developers and users.

## **Self-Contained, No Server Required**

Unlike most RDBMS products, SQLite does not have a client/server architecture. Most large-scale database systems have a large server package that makes up the database engine. The database server often consists of multiple processes that work in concert to manage client connections, file I/O, caches, query optimization, and query processing. A database instance typically consists of a large number of files organized into one or more directory trees on the server filesystem. In order to access the database, all of the files must be present and correct. This can make it somewhat difficult to move or reliably back up a database instance.

All of these components require resources and support from the host computer. Best practices also dictate that the host system be configured with dedicated service-user accounts, startup scripts, and dedicated storage, making the database server a very intrusive piece of software. For this reason, and for performance concerns, it is customary to dedicate a host computer system solely for the database server software.

To access the database, client software libraries are typically provided by the database vendor. These libraries must be integrated into any client application that wishes to access the database server. These client libraries provide APIs to find and connect to the database server, as well as set up and execute database queries and commands. [Figure 1-1](#) shows how everything fits together in a typical client/server RDBMS.

In contrast, SQLite has no separate server. The entire database engine is integrated into whatever application needs to access a database. The only shared resource among applications is the single database file as it sits on disk. If you need to move or back up the database, you can simply copy the file. [Figure 1-2](#) shows the SQLite infrastructure.

By eliminating the server, a significant amount of complexity is removed. This simplifies the software components and nearly eliminates the need for advanced operating system support. Unlike a traditional RDBMS server that requires advanced multitasking and high-performance inter-process communication, SQLite requires little more than the ability to read and write to some type of storage.



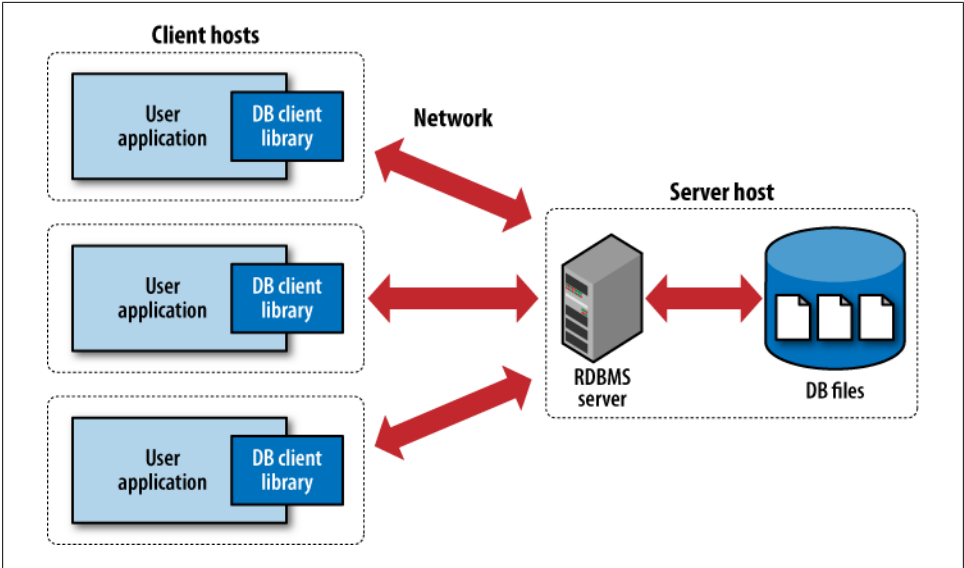

Figure 1-1. Traditional RDBMS client/server architecture that utilizes a client library.

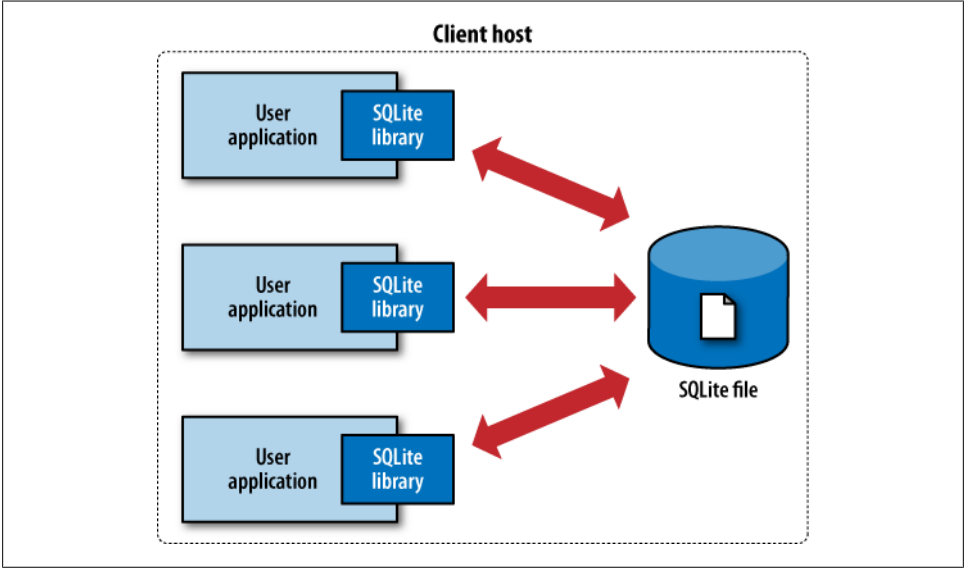

Figure 1-2. The SQLite server-less architecture.

This simplicity makes it fairly straightforward to port SQLite to just about any environment, including mobile phones, handheld media players, game consoles, and other devices, where no traditional database system could ever dare to venture.



Although SQLite does not use a traditional client/server architecture, it is common to speak of applications being “SQLite clients.” This terminology is often used to describe independent applications that simultaneously access a shared SQLite database file, and is not meant to imply that there is a separate server.

SQLite is designed to be integrated directly into an executable. This eliminates the need for an external library and simplifies distribution and installation. Removing external dependencies also removes most versioning issues. If the SQLite code is built right into your application, you never have to worry about linking to the correct version of a client library, or that the client library is version-compatible with the database server.

Eliminating the server imposes some restrictions, however. SQLite is designed to address localized storage needs, such as a web server accessing a local database. This means it isn’t well suited for situations where multiple client machines need to access a centralized database. That situation is more representative of a client/server architecture, and is better serviced by a database system that uses the same architecture.

## Single File Database

SQLite packages the entire database into a single file. That single file contains the database layout as well as the actual data held in all the different tables and indexes. The file format is cross-platform and can be accessed on any machine, regardless of native byte order or word size.

Having the whole database in a single file makes it trivial to create, copy, or back up the on-disk database image. Whole databases can be emailed to colleagues, posted to a web forum, or checked into a revision control system. Entire databases can be moved, modified, and shared with the same ease as a word-processing document or spreadsheet file. There is no chance of a database becoming corrupt or unavailable because one of a dozen files was accidentally moved or renamed.

Perhaps most importantly, computer users have grown to expect that a document, project, or other “unit of application data” is stored as a single file. Having the whole database in a single file allows applications to use database instances as documents, data stores, or preference data, without contradicting customer expectations.

## Zero Configuration

From an end-user standpoint, SQLite requires nothing to install, nothing to configure, and nothing to worry about. While there are a fair number of tuning parameters available to developers, these are normally hidden from the end-user. By eliminating the server and merging the database engine directly into your application, your customers never need to know they’re using a database. It is quite practical to design an application

so that selecting a file is the only customer interaction—an action they are already comfortable doing.

## Embedded Device Support

SQLite's small code size and conservative resource use makes it well suited for embedded systems running limited operating systems. The ANSI C source code tends toward an older, more conservative style that should be accepted by even the most eccentric embedded processor compiler. Using the default configuration, the compiled SQLite library is less than 700 KB on most platforms, and requires less than 4 MB of memory to operate. By omitting the more advanced features, the library can often be trimmed to 300 KB or less. With minor configuration changes, the library can be made to function on less than 256 KB of memory, making its total footprint not much more than half a megabyte, plus data storage.

SQLite expects only minimal support from its host environment and is written in a very modular way. The internal memory allocator can be easily modified or swapped out, while all file and storage access is done through a *Virtual File System* (VFS) interface that can be modified to meet the needs and requirements of different platforms. In general, SQLite can be made to run on almost anything with a 32-bit processor.

## Unique Features

SQLite offers several features not found in many other database systems. The most notable difference is that SQLite uses a dynamic-type system for tables. The SQLite engine will allow you to put any value into nearly any column, regardless of type. This is a major departure from traditional database systems, which tend to be statically typed. In many ways, the dynamic-type system in SQLite is similar to those found in popular scripting languages, which often have a single scalar type that can accept anything from integers to strings. In my own experience, the dynamic-type system has solved many more problems than it has caused.

Another useful feature is the ability to manipulate more than one database at a time. SQLite allows a single database connection to associate itself with multiple database files simultaneously. This allows SQLite to process SQL statements that bridge across multiple databases. This makes it trivial to join tables from different databases with a single query, or bulk copy data with a single command.

SQLite also has the ability to create fully in-memory databases. These are essentially database “files” that have no backing store and spend their entire lifetime within the file cache. While in-memory databases lack durability and do not provide full transaction support, they are very fast (assuming you have enough RAM), and are a great place to store temporary tables and other transient data.

There are a number of other features that make SQLite extremely flexible. Many of these, like virtual tables, are based off similar features found in other products, but with their own unique twist. These features and extensions provide a number of powerful tools to adapt SQLite to your own particular problem or situation.

## Compatible License

SQLite, and the SQLite code, have no user license. It is not covered by the *GNU General Public License* (GPL) or any of the similar open source/free-source licenses. Rather, the SQLite development team has chosen to place the SQLite source code in the public domain. This means that they have explicitly and deliberately relinquished any claim they have to copyright or ownership of the code or derived products.

In short, this basically means you can do whatever you want with the SQLite source code, short of claiming to own it. The code and compiled libraries can be used in any way, modified in any way, redistributed in any way, and sold in any way. There are no restrictions, and no requirements or obligations to make third-party changes or modifications available to the project or the public.

The SQLite team takes this decision very seriously. Great care is taken to avoid any potential software patents or patented algorithms. All contributions to the SQLite source require a formal copyright release. Commercial contributions also require signed affidavits stating that the authors (and, if applicable, their employers) release their work into the public domain.

All of this effort is taken to ensure that integrating SQLite into your product carries along minimal legal baggage or liability, making it a viable option for almost any development effort.

## Highly Reliable

The purpose of a database is to keep your data safe and organized. The SQLite development team is aware that nobody will use a database product that has a reputation for being buggy or unreliable. To maintain a high level of reliability, the core SQLite library is aggressively tested before each release.

In full, the standard SQLite test suites consists of over 10 million unit tests and query tests. The “soak test,” done prior to each release, consists of over 2.5 billion tests. The suite provides 100% statement coverage and 100% branch coverage, including edge-case errors, such as out-of-memory and out-of-storage conditions. The test suite is designed to push the system to its specified limits and beyond, providing extensive coverage of both code and operating parameters.

This high level of testing keeps the SQLite bug count relatively low. No software is perfect, but bugs that contribute to actual data-loss or database corruption are fairly rare. Most bugs that escape are performance related, where the database will do the right thing, but in the wrong way, leading to longer run-times.

Strong testing also keeps backwards compatibility extremely solid. The SQLite team takes backwards compatibility very seriously. File formats, SQL syntax, and programming APIs and behaviors have an extremely strong history of backwards compatibility. Updating to a new version of SQLite rarely causes compatibility problems.

In addition to keeping the core library reliable, the extensive testing also frees the SQLite developers to be more experimental. Whole subsystems of the SQLite code can be (and have been) ripped out and updated or replaced, with little concern about compatibility or functional differences—as long as all the tests pass. This allows the team to make significant changes with relatively little risk, constantly pushing the product and performance forward.

Like so many other aspects of the SQLite design, fewer bugs means fewer problems and less to worry about. As much as any complex piece of software can, it just works.



# Uses of SQLite

SQLite is remarkably flexible in both where it can be run and how it can be used. This chapter will take a brief look at some of the roles SQLite is designed to fill. Some of these roles are similar to those taken by traditional client/server RDBMS products. Other roles take advantage of SQLite's size and ease of use, offering solutions you might not consider with a full client/server database.

## Database Junior

Years of experience has taught developers that large client/server RDBMS platforms are powerful tools for safely storing, organizing, and manipulating data. Unfortunately, most large RDBMS products are resource-intensive and require a lot of upkeep. This boosts their performance and capacity, but it also limits how and where they can be practically deployed.

SQLite is designed to fill in those gaps, providing the same powerful and familiar tools for safely storing, organizing, and manipulating data in smaller, more resource constrained environments. SQLite is designed to complement, rather than replace, larger RDBMS platforms in situations where simplicity and ease of use are more important than capacity and concurrency.

This complimentary role enables applications and tools to embrace relational data management (and the years of experience that come with it), even if they're running on smaller platforms without administrative oversight. Developers may laugh at the idea of installing MySQL on a desktop system (or mobile phone!) just to support an address book application, but with SQLite this not only becomes possible, it becomes entirely practical.

## Application Files

Modern desktop applications typically deal with a significant number of files. Most applications and utilities have one or more preference files. There may also be system-wide and per-user configuration files, caches, and other data that must be tracked and stored. Document-based applications also need to store and access the actual document files.

Using the SQLite library as an abstract storage layer has many advantages. A fair amount of application metadata, such as caches, state data, and configuration data, fit well with the relational data model. This makes it relatively easy to create an appropriate database design that maps cleanly and easily into an application's internal data structures.

In many cases, SQLite can also work well as a document file format. Rather than creating a custom document format, an application can simply use individual database instances to represent working documents. SQLite supports many standard datatypes, including Unicode text, as well as arbitrary binary data fields that can store images or other raw data.

Even if an application does not have particularly strong relational requirements, there are still significant advantages to using the SQLite library as a storage container. The SQLite library provides incremental updates that make it quick and easy to save small changes. The transaction system protects all file I/O against process termination and power disruption, nearly eliminating the possibility of file corruption. SQLite even provides its own file caching layer, so that very large files can be opened and processed in a limited memory footprint, without any additional work on the part of the application.

SQLite database files are cross-platform, allowing easy migration. File contents can be easily and safely shared with other applications without worrying about detailed file format specifications. The common file format also makes it easy for automated scripts or troubleshooting utilities to access the files. Multiple applications can even access the same file simultaneously, and the library will transparently take care of all required file locking and cache synchronization.

The use of SQLite can also make debugging and troubleshooting much easier, as files can be inspected and manipulated with standard database tools. You can even use standard tools to inspect and modify a database file as your application is using it. Similarly, test files can be programmatically generated outside the application, which is useful for automatic testing suites.

Using an entire database instance as a document container may sound a bit unusual, but it is worth considering. The advantages are significant and should help a developer stay focused on the core of their application, rather than worrying about file formats, caching, or data synchronization.



## Application Cache

SQLite is capable of creating databases that are held entirely in memory. This is extremely useful for creating small, temporary databases that require no permanent storage.

In-memory databases are often used to cache results pulled from a more traditional RDBMS server. An application may pull a subset of data from the remote database, place it into a temporary database, and then process multiple detailed searches and refinements against the local copy. This is particularly useful when processing type-ahead suggestions, or any other interactive element that requires very quick response times.

Temporary databases can also be used to index and store nearly any type of inter-linked, cross-referenced data. Rather than designing a set of complex runtime data structures which might include multiple hash tables, trees, and cross-referenced pointers, the developer can simply design an appropriate database schema and load the data into the database.

While it might seem odd to execute SQL statements in order to extract data from an in-memory data structure, it is surprisingly efficient and can reduce development time and complexity. A database also provides an upgrade path, making it trivial to grow the data beyond the available memory or persist the data across application runs, simply by migrating to an on-disk database.

## Archives and Data Stores

SQLite makes it very easy to package complex data sets into a single, easy-to-access, fully cross-platform file. Having all the data in a single file makes it much easier to distribute or download large, multi-table data stores, such as large dictionaries or geo-location references.

Unlike many RDBMS products, the SQLite library is able to access read-only database files. This allows data stores to be read directly from an optical disc or other read-only filesystem. This is especially useful for systems with limited hard drive space, such as video game consoles.

## Client/Server Stand-in

SQLite works well as a “stand-in” database for those situations when a more robust RDBMS would normally be the right choice, were it available. SQLite can be especially useful for the demonstration and evaluation of applications and tools that normally depend on a database.

Consider a data analysis product that is designed to pull data from a relational database to generate reports and graphs. It can be difficult to offer downloads and evaluation

copies of such software. Even if a download is available, the software must be configured and authorized to connect to a database that contains applicable data. This presents a significant barrier for a potential customer.

Now consider an evaluation download that includes support for a bundled SQLite demonstration database. By simply downloading and running the software, customers can interact and experiment with the sample database. This makes the barrier of entry significantly lower, allowing a customer to go from downloading to running data in just a few seconds.

Similar concerns apply to traditional sales and marketing demonstrations. Reliable network connectivity is often unavailable when doing on-site demonstrations to potential clients, so it is standard practice to run a local database server for demonstration purposes. Running a local database server consumes significant resources and adds administrative overhead. Database licenses may also be a concern.

The use of SQLite eliminates these issues. The database becomes a background piece, allowing the demonstration to focus on the product. There are no database administration concerns. The simple file format also makes it easy to prepare customer-specific data sets or show off product features that significantly modify the database. All this can be done by simply making a copy of the database file before proceeding.

Beyond evaluations and demonstrations, SQLite support can be used to promote a “lite” or “personal edition” of a larger product. Adding an entry-level product that is more suitable and cost-effective for smaller installations can open up a significant number of new customers by providing a low-cost, no-fuss introduction to the product line.

SQLite support can even help with development and testing. SQLite databases are small and compact, allowing them to be attached to bug reports. They also provide an easy way to test a wide variety of situations, allowing a product to be tested against hundreds, if not thousands, of unique database instances. Even if a customer never sees an SQLite database, the integration time may easily pay for itself with improved testing and debugging capabilities.

## Teaching Tool

For the student looking to learn SQL and the basics of the relational model, SQLite provides an extremely accessible environment that is easy to set up, easy to use, and easy to share. SQLite offers a full-fledged relational system that supports nearly all of the core SQL language, yet requires no server setup, no administration, and no overhead. This allows students to focus on learning SQL and data manipulation without getting bogged down by server configuration and database maintenance.

Given its compact size, it is simple to place a Windows, Mac OS X, and Linux version of the command-line tools, along with several databases, onto a small flash drive. With no installation process and fully cross-platform database files, this provides an “on the go” teaching environment that will work with nearly any computer.

The “database in a file” architecture makes it easy for students to share their work. Whole database instances can be attached to an email or posted to a discussion forum. The single-file format also makes it trivial to back up work in progress, allowing students to experiment and explore different solutions without concern over losing data.

## Generic SQL Engine

SQLite virtual tables allow a developer to define the contents of a table through code. By defining a set of callback functions that fetch and return rows and columns, a developer can create a link between the SQLite data processing engine and any data source. This allows SQLite to run queries against the data source without importing the data into a standard table.

Virtual tables are an extremely useful way to generate reports or allow ad hoc queries against logs or any tabular data set. Rather than writing a set of custom search or reporting tools, the data can simply be exposed to the SQLite engine. This allows reports and queries to be expressed in SQL, a language that many developers are already familiar with using. It also enables the use of generic database visualization tools and report generators.

[Chapter 10](#) shows how to build a virtual table module that provides direct access to live web server logs.

## Not the Best Choice

Although SQLite has proven itself extremely flexible, there are some roles that are outside of its design goals. While SQLite may be able to perform in these areas, it might not be the best fit. If you find yourself with any of these requirements, it may be more practical to consider a more traditional client/server RDBMS product.

### *High Transaction Rates*

SQLite is able to support moderate transaction rates, but it is not designed to support the level of concurrent access provided by many client/server RDBMS products. Many server systems are able to provide table-level or row-level locking, allowing multiple transactions to be processed in parallel without the risk of data loss.

The concurrency protection offered by SQLite depends on file locks to protect against data loss. This model allows multiple database connections to access a database at the same time, but the whole database file must be locked in an exclusive mode to make any changes. As a result, write transactions are serialized across all database connections, limiting the overall transaction rate.

Depending on the size and complexity of your updates, SQLite might be able to handle a few hundred transactions per minute from different processes or threads. If, however, you start to see performance problems, or expect higher transaction rates, a client/server system is likely to provide better transaction performance.

### *Extremely Large Datasets*

It is not unusual to find SQLite databases that approach a dozen gigabytes or more, but there are some practical limits to the amount of data that can (or should) be stuffed into an SQLite database. Because SQLite puts everything into a single file (and thus, a single filesystem), very large data sets can stress the capability of the operating system or filesystem design. Although most modern filesystems are capable of handling files that are a terabyte or larger, that doesn't always mean they're very good at it. Many filesystems see a significant drop in performance for random access patterns if the file starts to get into multiple gigabyte ranges.

If you need to store and process several gigabytes or more of data, it might be wise to consider a more performance-oriented product.

### *Access Control*

An SQLite database has no authentication or authorization data. Instead, SQLite depends on filesystem permissions to control access to the raw database file. This essentially limits access to one of three states: complete read/write access, read-only access, or no access at all. Write access is absolute, and allows both data modification and the ability to alter the structure of the database itself.

While the SQLite API provides a basic application-layer authorization mechanism, it is trivial to circumvent if the user has direct access to the database file. Overall, this makes SQLite unsuitable for sensitive data stores that require per-user access control.

### *Client/Server*

SQLite is specifically designed without a network component, and is best used as a local resource. There is no native support for providing access to multiple computers over a network, making it a poor choice as a client/server database system.

Having multiple computers access an SQLite file through a shared directory is also problematic. Most networked filesystems have poor file-locking facilities. Without the ability to properly lock the file and keep updates synchronized, the database file can easily become corrupt.

This isn't to say that client/server systems can't utilize SQLite. For example, many web servers utilize SQLite. This works because all of the web server processes are running on the same machine and are all accessing the database file from local storage.

### *Replication*

SQLite has no internal support for database replication or redundancy. Simple replication can be achieved by copying the database file, but this must be done when nothing is attempting to modify the database.

Replication systems can be built on top of the basic database API, but such systems tend to be somewhat fragile. Overall, if you're looking for real-time replication—especially at a transaction-safe level—you'll need to look at a more complex RDBMS platform.

Most of these requirements get into a realm where complexity and administrative overhead is traded for capacity and performance. This makes sense for a large client/server RDBMS platform, but it is somewhat at odds with the SQLite design goals of staying simple and maintenance free. To keep frustration to a minimum, use the right tool for the job.

## **Big Name Users**

The SQLite website states that, “*SQLite is the most widely deployed SQL database engine in the world.*” This is a pretty bold claim, especially considering that when most people think of relational database platforms, they usually think of names like Oracle, SQL Server, and MySQL.

It is also a claim that is difficult to support with exact numbers. Because there are no license agreements or disclosure requirements, it is hard to guess just how many SQLite databases are out there. Nobody, including the SQLite development team, is fully aware of who is using SQLite, and for what purposes.

Regardless, the list of known SQLite users adds up to an impressive list. The Firefox web browser and the Thunderbird email client both use several SQLite databases to store cookies, history, preferences, and other account data. Many products from Skype, Adobe, and McAfee also utilize the SQLite engine. The SQLite library is also integrated into a number of popular scripting languages, including PHP and Python.

Apple, Inc., has heavily embraced SQLite, meaning that every iPhone, iPod touch, and iPad, plus every copy of iTunes, and many other Macintosh applications, all ship with several SQLite databases. The Symbian, Android, BlackBerry, and Palm webOS environments all provide native SQLite support, while WinCE has third-party support. Chances are, if you have a smartphone, it has a number of SQLite databases stored on it.

All of this adds up to millions, if not billions, of SQLite databases in the wild. No doubt that most of these databases only contain a few hundred kilobytes of data, but these low-profile environments are exactly where SQLite is designed to thrive.

Large client/server RDBMS platforms have shown thousands of developers the power of relational data management systems. SQLite has brought that power out of the server room to the desktops and mobile devices of the world.

---

# Building and Installing SQLite

This chapter is about building SQLite. We'll cover how to build and install the SQLite distribution on Linux, Mac OS X, and Windows. The SQLite code base supports all of these operating systems natively, and precompiled libraries and executables for all three environments are available from the SQLite website. All downloads, including source and precompiled binaries, can be found on the SQLite download webpage (<http://www.sqlite.org/download.html>).

## SQLite Products

The SQLite project consists of four major products:

### *SQLite core*

The SQLite core contains the actual database engine and public API. The core can be built into a static or dynamic library, or it can be built in directly to an application.

### *sqlite3 command-line tool*

The `sqlite3` application is a command-line tool that is built on top of the SQLite core. It allows a developer to issue interactive SQL commands to the SQLite core. It is extremely useful for developing and debugging queries.

### *Tcl extension*

SQLite has a strong history with the Tcl language. This library is essentially a copy of the SQLite core with the Tcl bindings tacked on. When compiled into a library, this code exposes the SQLite interfaces to the Tcl language through the *Tcl Extension Architecture* (TEA). Outside of the native C API, these Tcl bindings are the only official programming interface supported directly by the SQLite team.

### *SQLite analyzer tool*

The SQLite analyzer is used to analyze database files. It displays statistics about the database file size, fragmentation, available free space, and other data points. It is most useful for debugging performance issues related to the physical layout of the database file. It can also be used to determine if it is appropriate to `VACUUM` (repack and defragment) the database or not. The SQLite website provides precompiled `sqlite3_analyzer` executables for most desktop platforms. The source for the analyzer is only available through the development source distribution.

Most developers will be primarily interested in the first two products: the SQLite core and the `sqlite3` command-line tool. The rest of the chapter will focus on these two products. The build process for the Tcl extension is identical to building the SQLite core as a dynamic library. The analyzer tool is normally not built, but simply downloaded. If you want to build your own copy from scratch, you need a full development tree to do so.

## Precompiled Distributions

The SQLite download page includes precompiled, standalone versions of the `sqlite3` command-line tool for Linux, Mac OS X, and Windows. If you want to get started experimenting with SQLite, you can simply download the command-line tool, unpack it, run it, and start issuing SQL commands. You may not even have to download it first—Mac OS X and most Linux distributions include a copy of the `sqlite3` utility as part of the operating system. The SQLite download page also includes precompiled, standalone versions of the `sqlite3_analyzer` for all three operating systems.

Precompiled dynamic libraries of the SQLite core and the Tcl extension are also available for Linux and Windows. The Linux files are distributed as shared objects (`.so` files), while the Windows downloads contain DLL files. No precompiled libraries are available for Mac OS X. The libraries are only required if you are writing your own application, but do not wish to compile the SQLite core directly into your application.

## Documentation Distribution

The SQLite download page includes a documentation distribution. The `sqlite_docs_3_x_x.zip` file contains most of the static content from the SQLite website. The documentation online at the SQLite website is not versioned and always reflects the API and SQL syntax for the most recent version of SQLite. If you don't plan on continuously upgrading your SQLite distribution, it is useful to grab a copy of the documentation that goes with the version of SQLite you are using.



## Source Distributions

Most open source projects provide a single download that allows you to configure, build, and install the software with just a handful of commands. SQLite works a bit differently. Because the most common way to use SQLite is to integrate the core source directly into a host application, the source distributions are designed to make integration as simple as possible. Most of the source distributions contain only source code and provide minimal (if any) configuration or build support files. This makes it simpler to integrate SQLite into a host application, but if you want to build a library or `sqlite3` application, you will often need to do that by hand. As we'll see, that's fairly easy.

## The Amalgamation

The official code distribution is known as the *amalgamation*. The amalgamation is a single C source file that contains the entire SQLite core. It is created by assembling the individual development files into a single C source file that is almost 4 megabytes in size and over 100,000 lines long. The amalgamation, along with its corresponding header file, is all that is needed to integrate SQLite into your application.

The amalgamation has two main advantages. First, with everything in one file, it is extremely easy to integrate SQLite into a host application. Many projects simply copy the amalgamation files into their own source directories. It is also possible to compile the SQLite core into a library and simply link the library into your application.

Second, the amalgamation also helps improve performance. Many compiler optimizations are limited to a single translation unit. In C, that's a single source file. By putting the whole library into a single file, a good optimizer can process the whole package at once. Compared to compiling the individual source files, some platforms see a 5% or better performance boost just by using the amalgamation.

The only disadvantage of using the amalgamation is size. Some debuggers have issues with files more than 65,535 lines long. Things typically run correctly, but it can be difficult to set breakpoints or look at stack traces. Compiling a source file over 100,000 lines long also takes a fair number of resources. While this is no problem for most desktop systems, it may push the limits of any compilers running on limited platforms.

## Source Files

When working with the amalgamation, there are four important source files:

`sqlite3.c`

The amalgamation source file, which includes the entire SQLite core, plus common extensions.

*sqlite3.h*

The amalgamation header file, which exposes the core API.

*sqlite3ext.h*

The extension header file, which is used to build SQLite extensions.

*shell.c*

The `sqlite3` application source, which provides an interactive command-line shell.

The first two, *sqlite3.c* and *sqlite3.h*, are all that is needed to integrate SQLite into most applications. The *sqlite3ext.h* file is used to build extensions and modules. Building extensions is covered in “SQLite Extensions” on page 204. The *shell.c* file contains the source code for the `sqlite3` command-line shell. All of these files can be built on Linux, Mac OS X, or Windows, without any additional configuration files.

## Source Downloads

The SQLite website offers five source distribution packages. Most people will be interested in one of the first two files.

*sqlite-amalgamation-3\_x\_x.zip*

The Windows amalgamation distribution.

*sqlite-amalgamation-3.x.x.tar.gz*

The Unix amalgamation distribution.

*sqlite-3\_x\_x-tea.tar.gz*

The Tcl extension distribution.

*sqlite-3.x.x.tar.gz*

The Unix source tree distribution. This is unsupported and the build files are unmaintained.

*sqlite-source-3\_x\_x.zip*

The Windows source distribution. This is unsupported.

The Windows amalgamation file consists of the four main files, plus a *.def* file to build a DLL. No makefile, project, or solution files are included.

The Unix amalgamation file, which works on Linux, Mac OS X, and many other flavors of Unix, contains the four main files plus an `sqlite3` manual page. The Unix distribution also contains a basic *configure* script, along with other autoconf files, scripts, and makefiles. The autoconf files should also work under the Minimalist GNU for Windows (MinGW) environment (<http://www.mingw.org/>).

The Tcl extension distribution is a specialized version of the amalgamation. It is only of interest to those working in the Tcl language. See the included documentation for more details.

The Unix source tree is an unsupported legacy distribution. This is what the standard distribution looked like before the amalgamation became the officially supported distribution. It is made available for those that have older build environments or development branches that utilize the old distribution format. This distribution also includes a number of README files that are unavailable elsewhere.

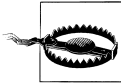

Although the source files are kept up to date, the configuration scripts and makefiles included in the Unix source tree distribution are no longer maintained and do not work properly on most platforms. Unless you have some significant need to use the source tree distribution, you should use one of the amalgamation distributions instead.

The Windows source distribution is essentially a *.zip* file of the source directory from the source tree distribution, minus some test files. It is strictly source files and header files, and contains no build scripts, makefiles, or project files.

## Building

There are a number of different ways to build SQLite, depending on what you're trying to build and where you would like it installed. If you are trying to integrate the SQLite core into a host application, the easiest way to do that is to simply copy *sqlite3.c* and *sqlite3.h* into your application's source directory. If you're using an IDE, the *sqlite3.c* file can simply be added to your application's project file and configured with the proper search paths and build directives. If you want to build a custom version of the SQLite library or *sqlite3* utility, it is also easy to do that by hand.

All of the SQLite source is written in C. It cannot be compiled by a C++ compiler. If you're getting errors related to structure definitions, chances are you're using a C++ compiler. Make sure you use a vanilla C compiler.

## Configure

If you're using the Unix amalgamation distribution, you can build and install SQLite using the standard *configure* script. After downloading the distribution, it is fairly easy to unpack, configure, and build the source:

```
$ tar xzf sqlite-amalgamation-3.x.x.tar.gz
$ cd sqlite-3.x.x
$ ./configure
[...]
```

```
$ make
```

By default, this will build the SQLite core into both static and dynamic libraries. It will also build the *sqlite3* utility. These will be built with many of the extra features (such as full text search and R\*Tree support) enabled. Once this finishes, the command *make install* will install these files, along with the header files and *sqlite3* manual page. By

default, everything is installed into `/usr/local`, although this can be changed by giving a `--prefix=/path/to/install` option to `configure`. Issue the command `configure --help` for information on other build options.

## Manually

Because the main SQLite amalgamation consists of only two source files and two header files, it is extremely simple to build by hand. For example, to build the `sqlite3` shell on Linux, or most other Unix systems:

```
$ cc -o sqlite3 shell.c sqlite3.c -ldl -lpthread
```

The additional libraries are needed to support dynamic linking and threads. Mac OS X includes those libraries in the standard system group, so no additional libraries are required when building for Mac OS X:

```
$ cc -o sqlite3 shell.c sqlite3.c
```

The commands are very similar on Windows, using the Visual Studio C compiler from the command-line:

```
> cl /Fesqlite3 shell.c sqlite3.c
```

This will build both the SQLite core and the shell into one application. That means the resulting `sqlite3` executable will not require an installed library in order to operate.

If you want to build things with one of the optional modules installed, you need to define the appropriate compiler directives. This shows how to build things on Unix with the FTS3 (full text search) extension enabled:

```
$ cc -DSQLITE_ENABLE_FTS3 -o sqlite3 shell.c sqlite3.c -ldl -lpthread
```

Or, on Windows:

```
> cl /Fesqlite3 /DSQLITE_ENABLE_FTS3 shell.c sqlite3.c
```

Building the SQLite core into a dynamic library is a bit more complex. We need to build the object file, then build the library using that object file. If you've already built the `sqlite3` utility, and have an `sqlite3.o` (or `.obj`) file, you can skip the first step. First, in Linux and most Unix systems:

```
$ cc -c sqlite3.c
$ ld -shared -o libsqlite3.so sqlite3.o
```

Some versions of Linux may also require the `-fPIC` option when compiling.

Mac OS X uses a slightly different dynamic library format, so the command to build it is slightly different. It also needs the standard C library to be explicitly linked:

```
$ cc -c sqlite3.c
$ ld -dylib -o libsqlite3.dylib sqlite3.o -lc
```

And finally, building a Windows DLL (which requires the *sqlite3.def* file):

```
> cl /c sqlite3.c  
> link /dll /out:sqlite3.dll /def:sqlite3.def sqlite3.obj
```

You may need to edit the *sqlite3.def* file to add or remove functions, depending on which compiler directives are used.

## Build Customization

The SQLite core is aware of a great number of compiler directives. [Appendix A](#) covers all of these in detail. Many are used to alter the standard default values, or to adjust some of the maximum sizes and limits. Compiler directives are also used to enable or disable specific features and extensions. There are several dozen directives in all.

The default build, without any specific directives, will work well enough for a wide variety of applications. However, if your application requires one of the extensions, or has specific performance concerns, there may be some ways to tune the build. Many of the parameters can also be adjusted at runtime, so a recompile may not always be necessary, but it can make development more convenient.

## Build and Installation Options

There are several different ways to build, integrate, and install SQLite. The design of the SQLite core lends itself to being compiled as a dynamic library. A single library can then be utilized by whatever application requires SQLite.

Building a shared library this way is one of the more straightforward ways to integrate and install SQLite, but it is often not the best approach. The SQLite project releases new versions rather frequently. While they take backward compatibility seriously, there are sometimes changes to the default configuration. There are also cases of applications becoming dependent on version-specific bugs or undefined (or undocumented) behaviors. There are also a large number of custom build options that SQLite supports. All these concerns can be difficult to create a system-wide build that is suitable for every application that uses SQLite.

This problem becomes worse as the number of applications utilizing SQLite continues to increase, making for more and more application-specific copies of SQLite. Even if an application (or suite of applications) has its own private copy of an SQLite library, there is still the possibility of incorrect linking and version incompatibilities.

To avoid these problems, the recommended way of using SQLite is to integrate the whole database engine directly into your application. This can be done by building a static library and then linking it in, or by simply building the amalgamation source directly into your application code. This method provides a truly custom build that is tightly bound to the application that uses it, eliminating any possibility of version or build incompatibilities.

About the only time it may be appropriate to use a dynamic library is when you're building against an existing system-installed (and system-maintained) library. This includes Mac OS X, many Linux distributions, as well as the majority of phone environments. In that case, you're depending on the operating system to keep a consistent build. This normally works for reasonably simple needs, but your application needs to be somewhat flexible. System libraries are often frozen with each major release, but chances are that sooner or later the system software (including the SQLite system libraries) will be upgraded. Your application may have to work across different versions of the system library if you need to support different versions of the operating system. For all these same reasons, it is ill-advised to manually replace or upgrade the system copy of SQLite.

If you do decide to use your own private library, take great care when linking. It is all too easy to accidentally link against a system library, rather than your private copy, if both are available.

Versioning problems, along with many other issues, can be completely avoided if the application simply contains its own copy of the SQLite core. The SQLite source distributions and the amalgamation make direct integration an easy path to take. Libraries have their place, but makes sure you understand the possible implications of having an external library. In specific, unless you control an entire device, never assume you're the only SQLite user. Try to keep your builds and installs clear of any system-wide library locations.

## An sqlite3 Primer

Once you have some form of SQLite installed, the first step is normally to run `sqlite3` and play around. The `sqlite3` tool accepts SQL commands from an interactive prompt and passes those commands to the SQLite core for processing.

Even if you have no intention of distributing a copy of `sqlite3` with your application, it is extremely useful to have a copy around for testing and debugging queries. If your application uses a customized build of the SQLite core, you will likely want to build a copy of `sqlite3` using the same build parameters.

To get started, just run the SQLite command. If you provide a filename (such as `test.db`), `sqlite3` will open (or create) that file. If no filename is given, `sqlite3` will automatically open an unnamed temporary database:

```
$ sqlite3 test.db
SQLite version 3.6.23.1
Enter ".help" for instructions
Enter SQL statements terminated with a ";"
sqlite>
```

The `sqlite>` prompt means `sqlite3` is ready to accept commands. We can start with some basic expressions:

```
sqlite> SELECT 3 * 5, 10;
15|10
sqlite>
```

SQL commands can also be entered across multiple lines. If no terminating semicolon is found, the statement is assumed to continue. In that case, the prompt will change to `...>` to indicate `sqlite3` is waiting for more input:

```
sqlite> SELECT 1 + 2,
...> 6 + 3;
3|9
sqlite>
```

If you ever find yourself at the `...>` prompt unexpectedly, make sure you finished up the previous line with a semicolon.

In addition to processing SQL statements, there is a series of shell-specific commands. These are sometimes referred to as “dot-commands” because they start with a period. Dot-commands control the shell’s output formatting, and also provide a number of utility features. For example, the `.read` command can be used to execute a file full of SQL commands.

Dot-commands must be given at the `sqlite>` prompt. They must be given on one line, and should not end in a semicolon. You cannot mix SQL statements and dot-commands.

Two of the more useful dot-commands (besides `.help`) are `.headers` and `.mode`. Both of these control some aspect of the database output. Turning headers on and setting the output mode to `column` will produce a table that most people find easier to read:

```
sqlite> SELECT 'abc' AS start, 'xyz' AS end;
abc|xyz
sqlite> .headers on
sqlite> .mode column
sqlite> SELECT 'abc' AS start, 'xyz' AS end;
start      end
-----
abc        xyz
sqlite>
```

Also helpful is the `.schema` command. This will list all of the DDL commands (`CREATE TABLE`, `CREATE INDEX`, etc.) used to define the database. For a more complete list of all the `sqlite3` command-line options and dot-commands, see [Appendix A](#).

## Summary

SQLite is designed to integrate into a wide variety of code bases on a broad range of platforms. This flexibility provides a great number of options, even for the most basic situations. While flexibility is usually a good thing, it can make for a lot of confusion when you're first trying to figure things out.

If you're just starting out, and all you need is a copy of the `sqlite3` shell, don't get too caught up in all the advanced build techniques. You can download one of the precompiled executables or build your own with the one-line commands provided in this chapter. That will get you started.

As your needs evolve, you may need a more specific build of `sqlite3`, or you may start to look at integrating the SQLite library into your own application. At that point you can try out different build techniques and see what best matches your needs and build environment.

While the amalgamation is a somewhat unusual form for source distribution, it has proven itself to be quite useful and well suited for integrating SQLite into larger projects with the minimal amount of fuss. It is also the only officially supported source distribution format. It works well for the majority of projects.



# The SQL Language

This chapter provides an overview of the *Structured Query Language*, or *SQL*. Although sometimes pronounced “sequel,” the official pronunciation is to name each letter as “ess-cue-ell.” The SQL language is the main means of interacting with nearly all modern relational database systems. SQL provides commands to configure the tables, indexes, and other data structures within the database. SQL commands are also used to insert, update, and delete data records, as well as query those records to look up specific data values.

All interaction with a relational database is done through the SQL language. This is true when interactively typing commands or when using the programming API. In all cases, data is stored, modified, and retrieved through SQL commands. Many times, people look through the list of API calls, looking for functions that provide direct program access to the table or index data structures. Functions of this sort do not exist. The API is structured around preparing and issuing SQL commands to the database engine. If you want to query a table or insert a value using the API, you must create and execute the proper SQL command. If you want to do relational database programming, you must know SQL.

## Learning SQL

The goal of this chapter is to introduce you to all the major SQL commands and show some of the basic usage patterns. The first time you read through this chapter, don't feel you need to absorb everything at once. Get an idea of what structures the database supports, and how they might be used, but don't feel that you need to memorize the details of every last command.

For people just getting started, the most important commands are `CREATE TABLE`, `INSERT`, and `SELECT`. These will let you create a table, insert some data into the table, and then query the data and display it. Once you get comfortable with those commands, you can start to look at the others in more depth. Feel free to refer back to this chapter, or the command reference in [Appendix C](#). The command reference provides detailed descriptions of each command, including some of the more advanced syntax that isn't covered in this chapter.

Always remember that SQL is a command language. It assumes you know what you're doing. If you're directly entering SQL commands through the `sqlite3` application, the program will not stop and ask for confirmation before processing dangerous or destructive commands. When entering commands by hand, it is always worth pausing and looking back at what you've typed before you hit return.

If you are already reasonably familiar with the SQL language, it should be safe to skim this chapter. Much of the information here is on the SQL language in general, but there is some information about the specific dialect of SQL that SQLite recognizes. Again, [Appendix C](#) provides a reference to the specific SQL syntax used by SQLite.

## Brief Background

Although the first official SQL specification was published in 1986 by the American National Standards Institute (ANSI), the language traces its roots back to the early 1970s and the pioneering relational database work that was being done at IBM. Current SQL standards are ratified and published by the International Standards Organization (ISO). Although a new standard is published every few years, the last significant set of changes to the core language can be traced to the SQL:1999 standard (also known as “SQL3”). Subsequent standards have mainly been concerned with storing and processing XML-based data. Overall, the evolution of SQL is firmly rooted in the practical aspects of database development, and in many cases new standards only serve to ratify and standardize syntax or features that have been present in commercial database products for some time.

## Declarative

The core of SQL is a *declarative language*. In a declarative language, you state what you want the results to be and allow the language processor to figure out how to deliver the desired results. Compare this to *imperative languages*, such as C, Java, Perl, or Python, where each step of a calculation or operation must be explicitly written out, leaving it up to the programmer to lead the program, step by step, to the correct conclusion.

The first SQL standards were specifically designed to make the language approachable and usable by “non-computer people”—at least by the 1980s definition of that term. This is one of the reasons why SQL commands tend to have a somewhat English-like

syntax. Most SQL commands take the form *verb-subject*. For example, CREATE (verb) TABLE (subject), DROP INDEX, UPDATE *table\_name*.

The almost-English, declarative nature of SQL has both advantages and disadvantages. Declarative languages tend to be simpler (especially for nonprogrammers) to understand. Once you get used to the general structure of the commands, the use of English keywords can make the syntax easier to remember. The fixed command structure also makes it much easier for the database engine to optimize queries and return data more efficiently.

The predefined nature of declarative statements can sometimes feel a bit limited, however—especially in a command-based language like SQL, where individual, isolated commands are constructed and issued one at a time. If you require a query that doesn't fit into the processing order defined by the SELECT command, you may find yourself having to patch together nested queries or temporary tables. This is especially true when the problem you're trying to solve is inherently nonrelational, and you're forced to jump through extra hoops to account for that.

Despite its oddities and somewhat organic evolution, SQL is a powerful language with a surprisingly broad ability to express complex operations. Once you wrap your head around what makes SQL tick, you can often find moderately simple solutions to even the most off-the-beaten-path problems. It can take some adjustment, however, especially if your primary experience is with imperative languages.

## Portability

SQL's biggest flaw is that formal standardization has almost always followed common implementations. Almost every database product (including SQLite) has custom extensions and enhancements to the core language that help differentiate it from other products, or expose features or control systems that are not covered by the core SQL standard. Often these enhancements are related to performance enhancements, and can be difficult to ignore.

While this less-strict approach to language purity has allowed SQL to grow and evolve in very practical ways, it means that “real world” SQL portability is not all that practical. If you strictly limit yourself to standardized SQL syntax, you can achieve a moderate degree of portability, but normally this comes at the cost of lower performance and less data integrity. Generally, applications will write to the specific SQL dialect they're using and not worry about cross-database compatibility. If cross-database compatibility is important to a specific application, the normal approach is to develop a core list of SQL commands required by the application, with minor tweaks for each specific database product.

SQLite makes an effort to follow the SQL standards as much as possible. SQLite will also recognize and correctly parse a number of nonstandard syntax conventions used by other popular databases. This can help with the portability issues.

SQL is not without other issues, but considering its lineage, it is surprisingly well suited for the task at hand. Love it or hate it, it is the relational database language of choice, and it is likely to be with us for a long time.

## General Syntax

Before getting into specific commands in SQL, it is worth looking at the general language structure. Like most languages, SQL has a fairly complete expression syntax that can be used to define command parameters. A more detailed description of the expression support can be found in [Appendix D](#).

## Basic Syntax

SQL consists of a number of different commands, such as `CREATE TABLE` or `INSERT`. These commands are issued and processed one at a time. Each command implements a different action or feature of the database system.

Although it is customary to use all capital letters for SQL commands and keywords, SQL is a case-insensitive\* language. All commands and keywords are case insensitive, as are identifiers (such as table names and column names).

Identifiers must be given as literals. If necessary, identifiers can be enclosed in the standards compliant double-quotes (" ") to allow the inclusion of spaces or other non-standard characters in an identifier. SQLite also allows identifiers to be enclosed in square brackets ([ ]) or back ticks (` `) for compatibility with other popular database products. SQLite reserves the use of any identifier that uses `sqlite_` as a prefix.

SQL is whitespace insensitive, including line breaks. Individual statements are separated by a semicolon. If you're using an interactive application, such as the `sqlite3` command-line tool, then you'll need to use a semicolon to indicate the end of a statement. The semicolon is not strictly required for single statements, however, as it is properly a statement separator and not a statement terminator. When passing SQL commands into the programming API, the semicolon is not required unless you are passing more than one command statement within a single string.

Single-line comments start with a double dash (--) and go to the end of the line. SQL also supports multi-line comments using the C comment syntax (`/* */`).

As with most languages, numeric literals are represented bare. Both integer (453) and real (rational) numbers (43.23) are recognized, as is exponent-style scientific notation (9.745e-6). In order to avoid ambiguities in the parser, SQLite requires that the decimal point is always represented as a period (.), regardless of the current internationalization setting.

\* Unless otherwise specified, case insensitivity only applies to ASCII characters. That is, characters represented by values less than 128.

Text literals are enclosed in single quotes (' '). To represent a string literal that includes a single quote character, use two single quotes in a row (`publisher = 'O'Reilly'`). C-style backslash escapes ( \ ) are not part of the SQL standard and are not supported by SQLite. BLOB literals (binary data) can be represented as an x (or X) followed by a string literal of hexadecimal characters (`x'A554E59C'`).



Text literals use single quotes. Double quotes are reserved for identifiers (table names, columns, etc.). C-style backslash escapes are not part of the SQL standard.

SQL statements and expressions frequently contain lists. A comma is used as the list separator. SQL does not allow for a trailing comma following the last item of a list.

In general, expressions can be used any place a literal data value is allowed. Expressions can include both mathematical statements, as well as functions. Function-calling syntax is similar to most other computer languages, utilizing the name of the function, followed by a list of parameters enclosed in parentheses. Expressions can be grouped into subexpressions using parentheses.

If an expression is evaluated in the context of a row (such as a filtering expression), the value of a row element can be extracted by naming the column. You may have to qualify the column name with a table name or alias. If you're using cross-database queries, you may also have to specify which database you're referring to. The syntax is:

```
[[database_name.]table_name.]column_name
```

If no database name is given, it is assumed you're referring to the `main` database on the default connection. If the table name/alias is also omitted, the system will make a best-guess using just the column name, but will return an error if the name is ambiguous.

## Three-Valued Logic

SQL allows any value to be assigned a `NULL`. `NULL` is not a value in itself (SQLite actually implements it as a unique valueless type), but is used as a marker or flag to represent unknown or missing data. The thought is that there are times when values for a specific row element may not be available or may not be applicable.

A `NULL` may not be a value, but it can be assigned to data elements that normally have values, and can therefore show up in expressions. The problem is that `NULL`s don't interact well with other values. If a `NULL` represents an unknown that might be any possible value, how can we know if the expression `NULL > 3` is true or false?

To deal with this problem, SQL must employ a concept called *three-valued logic*. Three-valued logic is often abbreviated *TVL* or *3VL*, and is more formally known as *ternary logic*. *3VL* essentially adds an "unknown" state to the familiar true/false Boolean logic system.

Here are the truth tables for the 3VL operators NOT, AND, and OR:

Value	NOT Value
True	False
False	True
NULL	NULL

3VL AND	TRUE	FALSE	NULL
TRUE	TRUE	FALSE	NULL
FALSE	FALSE	FALSE	FALSE
NULL	NULL	FALSE	NULL

3VL OR	TRUE	FALSE	NULL
TRUE	TRUE	TRUE	TRUE
FALSE	TRUE	FALSE	NULL
NULL	TRUE	NULL	NULL

3VL also dictates how comparisons work. For example, any equality check (=) involving a NULL will evaluate to NULL, including `NULL = NULL`. Remember that NULL is not a value, it is a flag for the unknown, so the expression `NULL = NULL` is asking, “Does this unknown equal that unknown?” The only practical answer is, “That is unknown.” It might, but it might not. Similar rules apply to greater-than, less-than, and other comparisons.



You cannot use the equality operator (=) to test for NULLs. You must use the `IS NULL` operator.

If you’re having trouble resolving an expression, just remember that a NULL marks an unknown or unresolved value. This is why the expression `False AND NULL` is false, but `True AND NULL` is NULL. In the case of the first expression, the NULL can be replaced by either true or false without altering the expression result. That isn’t true of the second expression, where the outcome is unknown (in other words, NULL) because the output depends on the unknown input.

## Simple Operators

SQLite supports the following unary prefix operators:

- +

These adjust the sign of a value. The “-” operator flips the sign of the value, effectively multiplying it by `-1.0`. The “+” operator is essentially a no-op, leaving a value with the same sign it previously had. It does not make negative values positive.

~

As in the C language, the “~” operator performs a bit-wise inversion. This operator is not part of the SQL standard.

NOT

The NOT operator reverses a Boolean expression using 3VL.

There are also a number of binary operators. They are listed here in descending precedence.

||

String concatenation. This is the only string concatenation operator recognized by the SQL standard. Many other database products allow “+” to be used for concatenation, but SQLite does not.

+ - \* / %

Standard arithmetic operators for addition, subtraction, multiplication, division, and modulus (remainder).

| & << >>

The bitwise operators *or*, *and*, and shift-high/shift-low, as found in the C language. These operators are not part of the SQL standard.

< <= => >

Comparison test operators. Again, just as in the C language we have less-than, less-than or equal, greater-than or equal, and greater than. These operators are subject to SQL’s 3VL regarding NULLs.

= == != <>

Equality test operators. Both “=” and “==” will test for equality, while both “!=” and “<>” test for inequality. Being logic operators, these tests are subject to SQL’s 3VL regarding NULLs. Specifically, `value = NULL` will always return NULL.

IN LIKE GLOB MATCH REGEXP

These five keywords are logic operators, returning, true, false, or NULL state. See [Appendix D](#) for more specifics on these operators.

AND OR

Logical operators. Again, they are subject to SQL’s 3VL.

In addition to these basics, SQL supports a number of specific expression operations. For more information on these and any SQL-specific expressions, see [Appendix D](#).

# SQL Data Languages

SQL commands are divided into four major categories, or *languages*. Each language defines a subset of commands that serve a related purpose. The first language is the *Data Definition Language*, or *DDL*, which refers to commands that define the structure of tables, views, indexes, and other data containers and objects within the database. `CREATE TABLE` (used to define a new table) and `DROP VIEW` (used to delete a view) are examples of DDL commands.

The second category of commands is known as *Data Manipulation Language*, or *DML*. These are all of the commands that insert, update, delete, and query actual data values from the data structures defined by the DDL. `INSERT` (used to insert new values into a table) and `SELECT` (used to query or look up data from tables) are examples of DML commands.

Related to the DML and DDL is the *Transaction Control Language*, or *TCL*. TCL commands can be used to control transactions of DML and DDL commands. `BEGIN` (used to begin a multistatement transaction) and `COMMIT` (used to end and accept a transaction) are examples of TCL commands.

The last category is the *Data Control Language*, or *DCL*. The main purpose of the DCL is to grant or revoke access control. Much like file permissions, DCL commands are used to allow (or deny) specific database users (or groups of users) permission to utilize or access specific resources within a database. These permissions can apply to both the DDL and the DML. DDL permissions might include the ability to create a real or temporary table, while DML permissions might include the ability to read, update, or delete the records of a specific table. `GRANT` (used to assign a permission) and `REVOKE` (used to delete an existing permission) are the primary DCL commands.

SQLite supports the majority of standardized DDL, DML, and TCL commands but lacks any DCL commands. Because SQLite does not have user names or logins, it does not have any concept of assigned permissions. Rather, SQLite depends on datatype permissions to define who can open and access a database.

## Data Definition Language

The DDL is used to define the structure of data containers and objects within the database. The most common of these containers and objects are tables, indexes, and views. As you'll see, most objects are defined with a variation of the `CREATE` command, such as `CREATE TABLE` or `CREATE VIEW`. The `DROP` command is used to delete an existing object (and all of the data it might contain). Examples include `DROP TABLE` or `DROP INDEX`. Because the command syntax is so different, statements like `CREATE TABLE` or `CREATE INDEX` are usually considered to be separate commands, and not variations of a single `CREATE` command.



In a sense, the DDL commands are similar to C/C++ header files. DDL commands are used to define the structure, names, and types of the data containers within a database, just as a header file typically defines type definitions, structures, classes, and other data structures. DDL commands are typically used to set up and configure a brand new database before data is entered.



DDL commands define the basic structure of the database and are typically run when a new database is created.

DDL commands are often held in a script file, so that the structure of the database can be easily recreated. Sometimes, especially during development, you may need to recreate only part of the database. To help support this, most `CREATE` commands in SQLite have an optional `IF NOT EXISTS` clause.

Normally, a `CREATE` statement will return an error if an object with the requested name already exists. If the optional `IF NOT EXISTS` clause is present, then this error is suppressed and nothing is done, even if the structure of the existing object and the new object are not compatible. Similarly, most `DROP` statements allow an optional `IF EXISTS` clause that silently ignores any request to delete an object that isn't there.

In the examples that follow, the `IF EXISTS` and `IF NOT EXISTS` command variations are not explicitly called out. Please see the SQLite command reference in [Appendix C](#) for the full details on the complete syntax supported by SQLite.

## Tables

The most common DDL command is `CREATE TABLE`. No data values can be stored in a database until a table is defined to hold that data. At the bare minimum, the `CREATE TABLE` command defines the table name, plus the name of each column. Most of the time you'll want to define a type for each column as well, although types are optional when using SQLite. Optional constraints, conditions, and default values can also be assigned to each column. Table-level constraints can also be assigned, if they involve multiple columns.

In some large RDBMS systems, `CREATE TABLE` can be quite complex, defining all kinds of storage options and configurations. SQLite's version of `CREATE TABLE` is somewhat simpler, but there are still a great many options available. For full explanation of the command, see [CREATE TABLE](#) in [Appendix C](#).

## The basics

The most basic syntax for `CREATE TABLE` looks something like this:

```
CREATE TABLE table_name
(
    column_name column_type,
    [...]
);
```

A table name must be provided to identify the new table. After that, there is just a simple list of column names and their types. Table names come from a global namespace of all identifiers, including the names of tables, views, and indexes.

Clear and concise identifier names are important. Like the database design itself, some careful thought should be put into the table name, trying to pin down the precise meaning of the data it contains. Much the same could be said of column names. Table names and column names tend to be referenced frequently in queries, so there is some desire to keep them as brief as possible while still keeping their purpose clear.

## Column types

Most databases use strong, static column typing. This means that the elements of a column can only hold values compatible with the column's defined type. SQLite utilizes a dynamic typing technique known as *manifest typing*. For each row value, manifest typing records the value's type along with the value data. This allows nearly any element of any row to hold almost any type of value.

In the strictest sense, SQLite supports only five concrete datatypes. These are known as *storage classes*, and represent the different ways SQLite might choose to store data on disk. Every value has one of these five native storage classes:

### *NULL*

A `NULL` is considered its own distinct type. A `NULL` type does not hold a value. Literal `NULL`s are represented by the keyword `NULL`.

### *Integer*

A signed integer number. Integer values are variable length, being 1, 2, 3, 4, 6, or 8 bytes in length, depending on the minimum size required to hold the specific value. Integer have a range of `-9,223,372,036,854,775,808` to `+9,223,372,036,854,775,807`, or roughly 19 digits. Literal integers are represented by any bare series of numeric digits (without commas) that does not include a decimal point or exponent.

### *Float*

A floating-point number, stored as an 8-byte value in the processor's native format. For nearly all modern processors, this is an IEEE 754 double-precision number. Literal floating-point numbers are represented by any bare series of numeric digits that include a decimal point or exponent.

### *Text*

A variable-length string, stored using the database encoding (UTF-8, UTF-16BE, or UTF-16LE). Literal text values are represented using character strings in single quotes.

### *BLOB*

A length of raw bytes, copied exactly as provided. Literal BLOBs are represented as hexadecimal text strings preceded by an x. For example, the notation x'1234ABCD' represents a 4-byte BLOB. BLOB stands for Binary Large Object.

SQLite text and BLOB values are always variable length. The maximum size of a text or BLOB value is limited by a compile-time directive. The default limit is exactly one billion bytes, or slightly less than a full gigabyte. The maximum value for this directive is two gigabytes.

Since the elements of most columns can hold any value type, the “type” of a column is a somewhat misleading concept. Rather than being an absolute type, as in most databases, an SQLite column type (as defined in `CREATE TABLE`) becomes more of a suggestion than a hard and fast rule. This is known as a *type affinity*, and essentially represents a desired category of type. Each type affinity has specific rules about what types of values it can store, and how different values will be converted when stored in that column. Generally, a type affinity will cause a conversion or migration of types only if it can be done without losing data or precision.

Each table column must have one of five type affinities:

### *Text*

A column with a text affinity will only store values of type `NULL`, `text`, or `BLOB`. If you attempt to store a value with a numeric type (`float` or `integer`) it will be converted into a text representation before being stored as a text value type.

### *Numeric*

A column with a numeric affinity will store any of the five types. Values with `integer` and `float` types, along with `NULL` and `BLOB` types, are stored without conversion. Any time a value with a text type is stored, an attempt is made to convert the value to a numeric type (`integer` or `float`). Assuming the conversion works, the value is stored in an appropriate numeric type. If the conversion fails, the text value is stored without any type of conversion.

### *Integer*

A column with an integer affinity works essentially the same as a numeric affinity. The only difference is that any value with a `float` type that lacks a fractional component will be converted into an integer type.

### *Float*

A column with a floating-point affinity also works essentially the same as a numeric affinity. The only difference is that most values with integer types are converted into floating-point values and stored as a `float` type.

*None*

A column with a none affinity has no preference over storage class. Each value is stored as the type provided, with no attempt to convert anything.

Since type affinities are not part of the SQL standard, SQLite has a series of rules that attempt to map traditional column types to the most logical type affinity. The type affinity of a column is determined by the declared type of the column, according to the following rules (substring matches are case-insensitive):

1. If no column type was given, then the column is given the none affinity.
2. If the column type contains the substring “INT,” then the column is given the integer affinity.
3. If the column type contains any of the substrings “CHAR,” “CLOB,” or “TEXT,” then the column is given the text affinity.
4. If the column type contains the substring “BLOB,” then the column is given the none affinity.
5. If the column type contains any of the substrings “REAL,” “FLOA,” or “DOUB,” then it is given the float affinity.
6. If no match is found, the column is assigned the numeric affinity.

As implied by the first rule, the column type is completely optional. SQLite will allow you to create a table by simply naming the columns, such as `CREATE TABLE t ( i, j, k);`. You’ll also notice that there isn’t any specific list of column types that are recognized. You can use any column type you want, even making up your own names.

This might sound a bit fast and loose for a typing system, but it works out quite well. By keying off specific substrings, rather than trying to define specific types, SQLite is able to handle SQL statements (and their database-specific types) from just about any database, all while doing a pretty good job of mapping the types to an appropriate affinity. About the only type you need to be careful of is “floating point.” The “int” in “point” will trigger rule 2 before the “floa” in “floating” will get to rule 5, and the column affinity will end up being *integer*.

## Column constraints

In addition to column names and types, a table definition can also impose constraints on specific columns or sets of columns. A more complete view of the `CREATE TABLE` command looks something like this:

```
CREATE TABLE table_name
(
    column_name column_type    column_constraints...,
    [... ,]

    table_constraints,
    [...]
);
```

Here we see that each individual column can have additional, optional constraints and modifiers placed on it. Column constraints only affect the column for which they are defined, while table constraints can be used to define a constraint across one or more columns. Constraints that involve two or more columns must be defined as table constraints.

Column constraints can be used to define a custom sort order (`COLLATE collation_name`). Collations determine how text values are sorted. In addition to user-defined collations, SQLite includes a `NOCASE` collation that ignores case when sorting.

A default value (`DEFAULT value`) can also be assigned. Nearly all columns have a default of `NULL`. You can use the `DEFAULT` column constraint to set a different default value. The default can either be a literal or an expression. Expressions must be placed in parentheses.

To help with date and time defaults, SQLite also includes three special keywords that may be used as a default value: `CURRENT_TIME`, `CURRENT_DATE`, and `CURRENT_TIMESTAMP`. These will record the UTC time, date, or date and time, respectively, when a new row is inserted. See [“Date and Time Features” on page 159](#) for more information on date and time functions.

Column constraints can also impose limits on a column, like denying `NULL` (`NOT NULL`) or requiring a unique value for each row (`UNIQUE`). Remember that a `NULL` is not considered a value, so `UNIQUE` does not imply `NOT NULL`, nor does `UNIQUE` imply only a single `NULL` is allowed. If you want to keep `NULL` assignments out of a `UNIQUE` column, you need to explicitly mark the column `NOT NULL`.

Column values can also be subjected to arbitrary user-defined constraints before they are assigned (`CHECK ( expression )`). Some types of constraints also allow you to specify the action to be taken in situations when the constraint would be violated. See [CREATE TABLE](#) and [UPDATE](#) in [Appendix C](#) for more specific details.

When multiple column constraints are used on a single column, the constraints are listed one after another without commas. Some examples:

```
CREATE TABLE parts
(
  part_id  INTEGER  PRIMARY KEY,
  stock    INTEGER  DEFAULT 0  NOT NULL,
  desc     TEXT     CHECK( desc != '' )  -- empty strings not allowed
);
```

In order to enforce a `UNIQUE` column constraint, a unique index will be automatically created over that column. A different index will be created for each column (or set of columns) marked `UNIQUE`. There is some expense in maintaining an index, so be aware that enforcing a `UNIQUE` column constraint can have performance considerations.

## Primary keys

In addition to these other constraints, a single column (or set of columns) can be designated as the `PRIMARY KEY`. Each table can have only one primary key. Primary keys must be unique, so designating a column as `PRIMARY KEY` implies the `UNIQUE` constraint as well, and will result in an automatic unique index being created. If a column is marked both `UNIQUE` and `PRIMARY KEY`, only one index will be created.

In SQLite, `PRIMARY KEY` does not imply `NOT NULL`. This is in contradiction to the SQL standard and is considered a bug, but the behavior is so long-standing that there are concerns about fixing it and breaking existing applications. As a result, it is always a good idea to explicitly mark at least one column from each `PRIMARY KEY` as `NOT NULL`.

There are also some good design reasons for defining a primary key, which will be discussed in “[Tables and Keys](#)” on page 87, but the only significant, concrete thing that comes out of defining a `PRIMARY KEY` is the automatic unique index. There are also some minor syntax shortcuts.

If, however, the primary key column has a type that is designated as `INTEGER` (and very specifically `INTEGER`), then that column becomes the table’s “root” column.

SQLite must have some column that can be used to index the base storage for the table. In a sense, that column acts as the master index that is used to store the table itself. Like many other database systems, SQLite will silently create a hidden `ROWID` column for this purpose. Different database systems use different names so, in an effort to maintain compatibility, SQLite will recognize the names `ROWID`, `OID`, or `_ROWID_` to reference the root column. Normally `ROWID` columns are not returned (even for column wildcards), nor are their values included in dump files.

If a table includes an `INTEGER PRIMARY KEY` column, then that column becomes an alias for the automatic `ROWID` column. You can still reference the column by any of the `ROWID` names, but you can also reference the column by its “real” user-defined name. Unlike `PRIMARY KEY` by itself, `INTEGER PRIMARY KEY` columns do have an automatic `NOT NULL` constraint associated with them. They are also strictly typed to only accept integer values.

There are two significant advantages of `INTEGER PRIMARY KEY` columns. First, because the column aliases the table’s root `ROWID` column, there is no need for a secondary index. The table itself acts as the index, providing efficient lookups without the maintenance costs of an external index.

Second, `INTEGER PRIMARY KEY` columns can automatically provide unique default values. When you insert a row without an explicit value for the `ROWID` (or `ROWID` alias) column, SQLite will automatically choose a value that is one greater than the largest existing value in the column. This provides an easy means to automatically generate unique keys. If the maximum value is reached, the database will randomly try other values, looking for an unused key.

INTEGER PRIMARY KEY columns can optionally be marked as AUTOINCREMENT. In that case, the automatically generated ID values will constantly increase, preventing the reuse of an ID value from a previously deleted row. If the maximum value is reached, insertions with automatic INTEGER PRIMARY KEY values are no longer possible. This is unlikely, however, as the INTEGER PRIMARY KEY type domain is large enough to allow 1,000 inserts per second for almost 300 million years.

When using either automatic or AUTOINCREMENT values, it is always possible to insert an explicit ROWID (or ROWID alias) value. Other than the INTEGER PRIMARY KEY designation, SQLite offers no other type of automatic sequence feature.

In addition to a PRIMARY KEY, columns can also be marked as a FOREIGN KEY. These columns reference rows in another (foreign) table. Foreign keys can be used to create links between rows in different tables. See “Tables and Keys” on page 87 for details.

### Table constraints

Table definitions can also include table-level constraints. In general, table constraints and column constraints work the same way. Table-level constraints still operate on individual rows. The main difference is that using the table constraint syntax, you can apply the constraint to a group of columns rather than just a single column. It is perfectly legal to define a table constraint with only one column, effectively defining a column constraint. Multicolumn constraints are sometimes known as *compound constraints*.

At the table level, SQLite supports the UNIQUE, CHECK, and PRIMARY KEY constraints. The check constraint is very similar, requiring only an expression (CHECK (*expression*)). Both the UNIQUE and PRIMARY KEY constraints, when given as a table constraint, require a list of columns (e.g., UNIQUE (*column\_name*, [...]), PRIMARY KEY (*column\_name*, [...])). As with column constraints, any table-level UNIQUE or PRIMARY KEY (which implies UNIQUE) constraint will automatically create a unique index over the appropriate columns.

Table constraints that are applied to multiple columns use the set of columns as a group. For example, when UNIQUE or PRIMARY KEY is applied across more than one column, each individual column is allowed to have duplicate values. The constraint only prevents the set of values across the designated columns from being replicated. If you wanted each individual column to also be UNIQUE, you’d need to add the appropriate constraints to the individual columns.

Consider a table that contains records of all the rooms in a multibuilding campus:

```
CREATE TABLE rooms
(
    room_number    INTEGER NOT NULL,
    building_number INTEGER NOT NULL,
    [...,]

    PRIMARY KEY( room_number, building_number )
);
```

Clearly we need to allow for more than one room with the number 101. We also need to allow for more than one room in building 103. But there should only be one room 101 in building 103, so we apply the constraint across both columns. In this example, we've chosen to make these columns into a compound primary key, since the building number and room number combine to quintessentially define a specific room. Depending on the design of the rest of the database, it might have been equally valid to define a simple `UNIQUE` constraint across these two columns, and designated an arbitrary `room_id` column as the primary key.

## Tables from queries

You can also create a table from the output of a query. This is a slightly different `CREATE TABLE` syntax that creates a new table and preloads it with data, all in one command:

```
CREATE [TEMP] TABLE table_name AS SELECT query_statement;
```

Using this form, you do not designate the number of columns or their names or types. Rather, the query statement is run and the output is used to define the column names and preload the new table with data. With this syntax, there is no way to designate column constraints or modifiers. Any result column that is a direct column reference will inherit the column's affinity, but all columns are given a `NONE` affinity. The query statement consists of a `SELECT` command. More information on `SELECT` can be found in [Chapter 5](#).

Tables created in this manner are not dynamically updated—the query command is run only once when the table is created. Once the data is entered into the new table, it remains unaltered until you change it. If you need a table-like object that can dynamically update itself, use a `VIEW` ([“Views” on page 43](#)).

This example shows the optional `TEMP` keyword (the full word `TEMPORARY` can also be used) in `CREATE TEMP TABLE`. This modifier can be used on any variation of `CREATE TABLE`, but is frequently used in conjunction with the `...AS SELECT...` variation shown here. Temporary tables have two specific features. First, temporary tables can only be seen by the database connection that created them. This allows the simultaneous reuse of table names without any worry of conflict between different clients. Second, all associated temporary tables are automatically dropped and deleted whenever a database connection is closed.

Generally speaking, `CREATE TABLE...AS SELECT` is not the best choice for creating standard tables. If you need to copy data from an old table into a new table, a better choice is to use `CREATE TABLE` to define an empty table with all of the appropriate column modifiers and table constraints. You can then bulk copy all the data into the new table using a variation of the `INSERT` command that allows for query statements. See [“INSERT” on page 46](#) for details.



## Altering tables

SQLite supports a limited version of the `ALTER TABLE` command. Currently, there are only two operations supported by `ALTER TABLE`: *add column* and *rename*. The *add column* variant allows you to add new columns to an existing table. It cannot remove them. New columns are always added to the end of the column list. Several other restrictions apply.

If you need to make a more significant change while preserving as much data as possible, you can use the *rename* variant to rename the existing table, create a new table under the original name, and then copy the data from the old table to the new table. The old table can then be safely dropped.

For full details, see [ALTER TABLE](#) in [Appendix C](#).

## Dropping tables

The `CREATE TABLE` command is used to create tables and `DROP TABLE` is used to delete them. The `DROP TABLE` command deletes a table and all of the data it contains. The table definition is also removed from the database system catalogs.

The `DROP TABLE` command is very simple. The only argument is the name of the table you wish to drop:

```
DROP TABLE table_name;
```

In addition to deleting the table, `DROP TABLE` will also drop any indexes associated with the table. Both automatically created indexes (such as those used to enforce a `UNIQUE` constraint) as well as manually created indexes will be dropped.

## Virtual tables

Virtual tables can be used to connect any data source to SQLite, including other databases. A virtual table is created with the `CREATE VIRTUAL TABLE` command. Although very similar to `CREATE TABLE`, there are important differences. For example, virtual tables cannot be made temporary, nor do they allow for an `IF NOT EXISTS` clause. To drop a virtual table, you use the normal `DROP TABLE` command.

For more information on virtual tables, including the full syntax for `CREATE VIRTUAL TABLE`, see [Chapter 10](#).

## Views

Views provide a way to package queries into a predefined object. Once created, views act more or less like read-only tables. Just like tables, new views can be marked as `TEMP`, with the same result. The basic syntax of the `CREATE VIEW` command is:

```
CREATE [TEMP] VIEW view_name AS SELECT query_statement
```

The `CREATE VIEW` syntax is almost identical to the `CREATE TABLE...AS SELECT` command. This is because both commands serve a similar purpose, with one important difference. The result of a `CREATE TABLE` command is a new table that contains a full copy of the data. The `SELECT` statement is run exactly once and the output of the query is stored in the newly defined table. Once created, the table will hold its own, independent copy of the data.

A view, on the other hand, is fully dynamic. Every time the view is referenced or queried, the underlying `SELECT` statement is run to regenerate the view. This means the data seen in a view automatically updates as the data changes in the underlying tables. In a sense, views are almost like named queries.

Views are commonly used in one of two ways. First, they can be used to package up commonly used queries into a more convenient form. This is especially true if the query is complex and prone to error. By creating a view, you can be sure to get the same query each time.

Views are also commonly used to create user-friendly versions of standard tables. A common example are tables with date and time records. Normally, any time or date value is recorded in Coordinated Universal Time, or UTC. UTC is a more proper format for dates and times because it is unambiguous and time-zone independent. Unfortunately, it can also be a bit confusing if you're several time zones away. It is often useful to create a view that mimics the base table, but converts all the times and dates from UTC into the local time zone. This way the data in the original tables remains unchanged, but the presentation is in units that are more user-friendly.

Views are dropped with the `DROP VIEW` command:

```
DROP VIEW view_name;
```

Dropping a view will not have any effect on the tables it references.

## Indexes

Indexes (or indices) are a means to optimize database lookups by pre-sorting and indexing one or more columns of a table. Ideally, this allows specific rows in a table to be found without having to scan every row in the table. In this fashion, indexes can provide a large performance boost to some types of queries. Indexes are not free, however, requiring updates with each modification to a table as well as additional storage space. There are even some situations when an index will cause a drop in performance. See [“Indexes” on page 107](#) for more information on when it makes sense to use an index.

The basic syntax for creating an index specifies the name of the new index, as well as the table and column names that are indexed. Indexes are always associated with one (and only one) table, but they can include one or more columns from that table:

```
CREATE [UNIQUE] INDEX index_name ON table_name ( column_name [, ...] );
```

Normally indexes allow duplicate values. The optional `UNIQUE` keyword indicates that duplicate entries are not allowed, and any attempt to insert or update a table with a nonunique value will cause an error. For unique indexes that reference more than one column, all the columns must match for an entry to be considered duplicate. As discussed with `CREATE TABLE`, `NULL` isn't considered a value, so a `UNIQUE` index will not prevent one or more `NULL`s. If you want to prevent `NULL`s, you must indicate `NOT NULL` in the original table definition.

Each index is tied to a specific table, but they all share a common namespace. Although you can name an index anything you like, it is standard practice to name an index with a standard prefix (such as `idx_`), and then include the table name and possibly the names of the columns included in the index. For example:

```
CREATE INDEX idx_employees_name ON employees ( name );
```

This makes for long index names but, unlike table or view names, you typically only reference an index's name when you create it and when you drop it.

As with all the `DROP` commands, the `DROP INDEX` command is very simple, and requires only the name of the index that is being dropped:

```
DROP INDEX index_name;
```

Dropping an index will remove the index from the database, but will leave the associated table intact.

As described earlier, the `CREATE TABLE` command will automatically create unique indexes to enforce a `UNIQUE` or `PRIMARY KEY` constraint. All automatic indexes will start with an `sqlite_` prefix. Because these indexes are required to enforce the table definition, they cannot be manually dropped with the `DROP INDEX` command. Dropping the automatic indexes would alter the table behavior as defined by the original `CREATE TABLE` command.

Conversely, if you have manually defined a `UNIQUE` index, dropping that index will allow the database to insert or update redundant data. Be careful when auditing indexes and remember that not all indexes are created for performance reasons.

## Data Manipulation Language

The Data Manipulation Language is all about getting user data in and out of the database. After all the data structures and other database objects have been created with DDL commands, DML commands can be used to load those data structures full of useful data.

The DML supported by SQLite falls into two basic categories. The first category consists of the “update” commands, which includes the actual `UPDATE` command, as well as the `INSERT` and `DELETE` commands. As you might guess, these commands are used to update (or modify), insert, and delete the rows of a table. All of these commands alter

the stored data in some way. The update commands are the primary means of managing all the data within a database.

The second category consists of the “query” commands, which are used to extract data from the database. Actually, there is only one query command: `SELECT`. The `SELECT` command not only prints returned values, but provides a great number of options to combine different tables and rows and otherwise manipulate data before returning the final result.

`SELECT` is, unquestionably, the most complex SQL command. It is also, arguably, the most important SQL command. This chapter will only cover the very basics of `SELECT`, and then we will spend the next chapter going through all of its parts, bit by bit. To address the full command syntax in detail, `SELECT` gets a whole chapter to itself ([Chapter 5](#)).

## Row Modification Commands

There are three commands used for adding, modifying, and removing data from the database. `INSERT` adds new rows, `UPDATE` modifies existing rows, and `DELETE` removes rows. These three commands are used to maintain all of the actual data values within the database. All three update commands operate at a row level, adding, altering, or removing the specified rows. Although all three commands are capable of acting on multiple rows, each command can only directly act upon rows contained within a single table.

### INSERT

The `INSERT` command is used to create new rows in the specified table. There are two meaningful versions of the command. The first version uses a `VALUES` clause to specify a list of values to insert:

```
INSERT INTO table_name (column_name [, ...]) VALUES (new_value [, ...]);
```

A table name is provided, along with a list of columns and a list of values. Both lists must have the same number of items. A single new row is created and each value is recorded into its respective column. The columns can be listed in any order, just as long as the list of columns and the list of values line up correctly. Any columns that are not listed will receive their default values:

```
INSERT INTO parts ( name, stock, status ) VALUES ( 'Widget', 17, 'IN STOCK' );
```

In this example, we attempt to insert a new row into a “parts” table. Note the use of single quotes for text literals.

Technically, the list of column names is optional. If no explicit list of columns is provided, the `INSERT` command will attempt to pair up values with the table’s full list of columns:

```
INSERT INTO table_name VALUES (new_value [, ...]);
```

The trick with this format is that the number and order of values must exactly match the number and order of columns in the table definition. That means it is impossible to use default values, even on `INTEGER PRIMARY KEY` columns. More often than not, this is not actually desirable. This format is also harder to maintain within application source code, since it must be meticulously updated if the table format changes. In general, it is recommended that you always explicitly list out the columns in an `INSERT` statement.

When bulk importing data, it is common to loop over data sets, calling `INSERT` over and over. Processing these statements one at a time can be fairly slow, since each command will update both the table and any relevant indexes, and then make sure the data is fully written out to physical disk before (finally!) starting the next `INSERT`. This is a fairly lengthy process, since it requires physical I/O.

To speed up bulk inserts, it is common to wrap groups of 1,000 to 10,000 `INSERT` statements into a single transaction. Grouping the statement together will substantially increase the overall speed of the inserts by delaying the physical I/O until the end of the transaction. See [“Transaction Control Language” on page 51](#) for more information on transactions.



Bulk inserts can be sped up by wrapping large groups of `INSERT` commands inside a transaction.

The second version of `INSERT` allows you to define values by using a query statement. This is very similar to the `CREATE TABLE...AS SELECT` command, although the table must already exist. This is the only version of `INSERT` that can insert more than one row with a single command:

```
INSERT INTO table_name (column_name, [...]) SELECT query_statement;
```

This type of `INSERT` is most commonly used to bulk copy data from one table to another. This is a common operation when you need to update the definition of a table, but you don't want to lose all the data that already exists in the database. The old table is renamed, the new table is defined, and the data is copied from the old table into the new table using an `INSERT INTO...SELECT` command. This form can also be used to populate temporary tables or copy data from one attached database to another.

As with the `VALUES` version of `INSERT`, the column list is technically optional but, for all the same reasons, it is still recommended that you provide an explicit column list.

All versions of the `INSERT` command also support an optional conflict resolution clause. This conflict clause determines what should be done if the results of the `INSERT` would violate a database constraint. The most common example is `INSERT OR REPLACE`, which comes into play when the `INSERT` would, as executed, cause a `UNIQUE` constraint violation. If the `REPLACE` conflict resolution is present, any existing row that would cause a

UNIQUE constraint violation is first deleted, and then the INSERT is allowed to continue. This specific usage pattern is so common that the whole INSERT OR REPLACE phrase can be replaced by just REPLACE. For example, REPLACE INTO *table\_name*...

See [INSERT](#) and [UPDATE](#) in [Appendix C](#) for more information on the details of conflict resolution.

## UPDATE

The UPDATE command is used to assign new values to one or more columns of existing rows in a table. The command can update more than one row, but all of the rows must be part of the same table. The basic syntax is:

```
UPDATE table_name SET column_name=new_value [, ...] WHERE expression
```

The command requires a table name followed by a list of column name/value pairs that should be assigned. Which rows are updated is determined by a conditional expression that is tested against each row of the table. The most common usage pattern uses the expression to check for equality on some unique column, such as a PRIMARY KEY column.

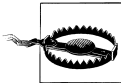

If no WHERE condition is given, the UPDATE command will attempt to update the designated columns in *every* row of a table.

It is not considered an error if the WHERE expression evaluates to false for every row in the table, resulting in no actual updates.

Here is a more specific example:

```
-- Update the price and stock of part_id 454:  
UPDATE parts SET price = 4.25, stock = 75 WHERE part_id = 454;
```

This example assumes that the table `parts` has at least three columns: `price`, `stock`, and `part_id`. The database will find each row with a `part_id` of 454. In this case, it can be assumed that `part_id` is a PRIMARY KEY column, so only one row will be updated. The `price` and `stock` columns of that row are then assigned new values.

The full syntax for UPDATE can be found at [UPDATE](#) in [Appendix C](#).

## DELETE

As you might guess, the DELETE command is used to delete or remove one or more rows from a single table. The rows are completely deleted from the table:

```
DELETE FROM table_name WHERE expression;
```

The command requires only a table name and a conditional expression to pick out rows. The WHERE expression is used to select specific rows to delete, just as it is used in the UPDATE command.



If no **WHERE** condition is given, the **DELETE** command will attempt to delete *every* row of a table.

As with **UPDATE**, it is not considered an error if the **WHERE** expression evaluates to false for every row in the table, resulting in no actual deletions.

Some specific examples:

```
-- Delete the row with rowid 385:  
DELETE FROM parts WHERE part_id = 385;  
  
-- Delete all rows with a rowid greater than or equal to 43  
-- and less than or equal to 246:  
DELETE FROM parts WHERE part_id >= 43 AND part_id <= 246;
```

These examples assume we have a table named **parts** that contains at least one unique column named **part\_id**.

As noted, if no **WHERE** clause is given, the **DELETE** command will attempt to delete every row in a table. SQLite optimizes this specific case, truncating the full table, rather than processing each individual row. Truncating the table is much faster than deleting each individual row, but truncation bypasses the individual row processing. If you wish to process each row as it is deleted, provide a **WHERE** clause that always evaluates to true:

```
DELETE FROM parts WHERE 1; -- delete all rows, force per-row processing
```

The existence of the **WHERE** clause will prevent the truncation, allowing each row to be processed in turn.

## The Query Command

The final DML command to cover is the **SELECT** command. **SELECT** is used to extract or return values from the database. Almost any time you want to extract or return some kind of value, you'll need to use the **SELECT** command. Generally, the returned values are derived from the contents of the database, but **SELECT** can also be used to return the value of simple expressions. This is a great way to test out expressions, for example:

```
sqlite> SELECT 1+1, 5*32, 'abc' || 'def', 1>2;  
1+1      5*32      'abc' || 'def'  1>2  
-----  
2         160         abcdef          0
```

**SELECT** is a read-only command, and will not modify the database (unless the **SELECT** is embedded in a different command, such as a **CREATE TABLE...AS SELECT** or an **INSERT INTO...SELECT**).

Without question, **SELECT** is the most complex SQL command, both in terms of syntax as well as function. The **SELECT** syntax tries to represent a generic framework that is capable of expressing a great many different types of queries. While it is somewhat successful at this, there are areas where **SELECT** has traded away simplicity for more

flexibility. As a result, `SELECT` has a large number of optional clauses, each with its own set of options and formats.

Understanding how to mix and match these optional clauses to get the result you're looking for can take some time. While the most basic syntax can be shown with a good set of examples, to really wrap your head around `SELECT`, it is best to understand how it actually works and what it is trying to accomplish.

Because `SELECT` can be so complex, and because `SELECT` is an extremely important command, we will spend the whole next chapter looking very closely at `SELECT` and each of its clauses. There will be some discussion about what is going on behind the scenes, to provide more insight into how to read and write complex queries.

For now, we'll just give you a taste. That should provide enough information to play around with the other commands in this chapter. The most basic form of `SELECT` is:

```
SELECT output_list FROM input_table WHERE row_filter;
```

The output list is a list of expressions that should be evaluated and returned for each resulting row. Most commonly, this is simply a list of columns. The output list can also include a wildcard (\*) that indicates all known columns should be returned.

The `FROM` clause defines the source of the table data. The next chapter will show how tables can be linked and joined, but for now we'll stick with querying one table at a time.

The `WHERE` clause is a conditional filtering expression that is applied to each row. It is essentially the same as the `WHERE` clause in the `UPDATE` and `DELETE` commands. Those rows that evaluate to true will be part of the result, while the other rows will be filtered out.

Consider this table:

```
sqlite> CREATE TABLE tbl ( a, b, c, id INTEGER PRIMARY KEY );
sqlite> INSERT INTO tbl ( a, b, c ) VALUES ( 10, 10, 10 );
sqlite> INSERT INTO tbl ( a, b, c ) VALUES ( 11, 15, 20 );
sqlite> INSERT INTO tbl ( a, b, c ) VALUES ( 12, 20, 30 );
```

We can return the whole table like this:

```
sqlite> SELECT * FROM tbl;
a      b      c      id
-----
10     10     10     1
11     15     20     2
12     20     30     3
```

We can also just return specific columns:

```
sqlite> SELECT a, c FROM tbl;
a      c
-----
10     10
11     20
12     30
```



Or specific rows:

```
sqlite> SELECT * FROM tbl WHERE id = 2;
a      b      c      id
-----
11     15     20     2
```

For more specifics, see [Chapter 5](#) and [SELECT](#) in [Appendix C](#).

## Transaction Control Language

The Transaction Control Language is used in conjunction with the Data Manipulation Language to control the processing and exposure of changes. Transactions are a fundamental part of how relational databases protect the integrity and reliability of the data they hold. Transactions are automatically used on all DDL and DML commands.

### ACID Transactions

A transaction is used to group together a series of low-level changes into a single, logical update. A transaction can be anything from updating a single value to a complex, multistep procedure that might end up inserting several rows into a number of different tables.

The classic transaction example is a database that holds account numbers and balances. If you want to transfer a balance from one account to another, that is a simple two-step process: subtract an amount from one account balance and then add the same amount to the other account balance. That process needs to be done as a single logical unit of change, and should not be broken apart. Both steps should either succeed completely, resulting in the balance being correctly transferred, or both steps should fail completely, resulting in both accounts being left unchanged. Any other outcome, where one step succeeds and the other fails, is not acceptable.

Typically a transaction is opened, or started. As individual data manipulation commands are issued, they become part of the transaction. When the logical procedure has finished, the transaction can be committed, which applies all of the changes to the permanent database record. If, for any reason, the commit fails, the transaction is rolled back, removing all traces of the changes. A transaction can also be manually rolled back.

The standard for reliable, robust transactions is the ACID test. *ACID* stands for *Atomic*, *Consistent*, *Isolated*, and *Durable*. Any transaction system worth using must possess these qualities.

#### *Atomic*

A transaction should be atomic, in the sense that the change cannot be broken down into smaller pieces. When a transaction is committed to the database, the entire transaction must be applied or the entire transaction must *not* be applied. It should be impossible for only part of a transaction to be applied.

### *Consistent*

A transaction should also keep the database consistent. A typical database has a number of rules and limits that help ensure the stored data is correct and consistent with the design of the database. Assuming a database starts in a consistent state, applying a transaction must keep the database consistent. This is important, because the database is allowed to (and is often required to) become inconsistent while the transaction is open. For example, while transferring funds, there is a moment between the subtraction from one account and the addition to another account that the total amount of funds represented in the database is altered and may become inconsistent with a recorded total. This is acceptable, as long as the transaction, as a whole, is consistent when it is committed.

### *Isolated*

An open transaction must also be isolated from other clients. When a client opens a transaction and starts to issue individual change commands, the results of those commands are visible to the client. Those changes should *not*, however, be visible to any other system accessing the database, nor should they be integrated into the permanent database record until the entire transaction is committed. Conversely, changes committed by other clients after the transaction was started should not be visible to this transaction. Isolation is required for transactions to be atomic and consistent. If other clients could see half-applied transactions, the transactions could not claim to be atomic in nature, nor would they preserve the consistency of the database, as seen by other clients.

### *Durable*

Last of all, a transaction must be durable. If the transaction is successfully committed, it must have become a permanent and irreversible part of the database record. Once a success status is returned, it should not matter if the process is killed, the system loses power, or the database filesystem disappears—upon restart, the committed changes should be present in the database. Conversely, if the system loses power before a transaction is committed, then upon restart the changes made within the transaction should *not* be present.

Most people think that the atomic nature of transactions is their most important quality, but all four aspects must work together to ensure the overall integrity of the database. Durability, especially, is often overlooked. SQLite tries extremely hard to guarantee that if a transaction is successfully committed, those changes are actually physically written to permanent storage and are there to stay. Compare this to traditional filesystem operations, where writes might go into an operating system file cache. Updates may sit in the cache anywhere from a few seconds to a few minutes before finally being spooled off to storage. Even then, it is possible for the data to wait around in device buffers before finally being committed to physical storage. While this type of buffering can increase efficiency, it means that a normal application really has no idea when its data is safely committed to permanent storage.

Power failures and disappearing filesystems may seem like rare occurrences, but that's not really the point. Databases are designed to deal with absolutes, especially when it comes to reliability. Besides, having a filesystem disappear is not that radical of an idea when you consider the prevalence of flash drives and USB thumb drives. Disappearing media and power failures are even more commonplace when you consider the number of SQLite databases that are found on battery-operated, handheld devices such as mobile phones and media players. The use of transactions is even more important on devices like this, since it is nearly impossible to run data recovery tools in that type of environment. These types of devices must be extremely robust and, no matter what the user does (including yanking out flash drives at inconvenient times), the system must stay consistent and reliable. Use of a transactional system can provide that kind of reliability.

Transactions are not just for writing data. Opening a transaction for an extended read-only operation is sometimes useful if you need to gather data with multiple queries. Having the transaction open keeps your view of the database consistent, ensuring that the data doesn't change between queries. That is useful if, for example, you use one query to gather a bunch of record IDs, and then issue a series of queries against each ID value. Wrapping all the queries in a transaction guarantees all of the queries see the same set of data.

## SQL Transactions

Normally, SQLite is in *autocommit* mode. This means that SQLite will automatically start a transaction for each command, process the command, and (assuming no errors were generated) automatically commit the transaction. This process is transparent to the user, but it is important to realize that even individually entered commands are processed within a transaction, even if no TCL commands are used.

The autocommit mode can be disabled by explicitly opening a transaction. The `BEGIN` command is used to start or open a transaction. Once an explicit transaction has been opened, it will remain open until it is committed or rolled back. The keyword `TRANSACTION` is optional:

```
BEGIN [ DEFERRED | IMMEDIATE | EXCLUSIVE ] [ TRANSACTION ]
```

The optional keywords `DEFERRED`, `IMMEDIATE`, or `EXCLUSIVE` are specific to SQLite and control how the required read/write locks are acquired. If only one client is accessing the database at a time, the locking mode is largely irrelevant. When more than one client may be accessing the database, the locking mode defines how to balance peer access with ensured success of the transaction.

By default, all transactions (including autocommit transactions) use the `DEFERRED` mode. Under this mode, none of the database locks are acquired until they are required. This is the most “neighborly” mode and allows other clients to continue accessing and using the database until the transaction has no other choice but to lock them out. This allows

other clients to continue using the database, but if the locks are not available when the transaction requires them, the transaction will fail and may need to be rolled back and restarted.

**BEGIN IMMEDIATE** attempts to acquire a reserved lock immediately. If it succeeds, it guarantees the write locks will be available to the transaction when they are needed, but still allows other clients to continue to access the database for read-only operations. The **EXCLUSIVE** mode attempts to lock out *all* other clients, including read-only clients. Although the **IMMEDIATE** and **EXCLUSIVE** modes are more restrictive to other clients, the advantage is that they will fail immediately if the required locks are not available, rather than after you've issued your DDL or DML commands.

Once a transaction is open, you can continue to issue other SQL commands, including both DML and DDL commands. You can think of the changes resulting from these commands as “proposed” changes. The changes are only visible to the local client and have not been fully and permanently applied to the database. If the client process is killed or the server loses power in the middle of an open transaction, the transaction and any proposed changes it has will be lost, but the rest of the database will remain intact and consistent. It is not until the transaction is closed that the proposed changes are committed to the database and made “real.” The **COMMIT** command is used to close out a transaction and commit the changes to the database. You can also use the alias **END**. As with **BEGIN**, the **TRANSACTION** keyword is optional.

```
COMMIT [TRANSACTION]
END [TRANSACTION]
```

Once a **COMMIT** has successfully returned, all the proposed changes are fully committed to the database and become visible to other clients. At that point, if the system loses power or the client process is killed, the changes will remain safely in the database.

Things don't always go right, however. Rather than committing the proposed changes, the transaction can be manually rolled back, effectively canceling the transaction and all of the changes it contains. Rolling back a set of proposed changes is useful if an error is encountered. This might be a database error, such as running out of disk space half-way through inserting a series of related records, or it might be an application logic error, such as trying to assign an invoice to an order that doesn't exist. In such cases, it usually doesn't make sense to continue with the transaction, nor does it make sense to leave inconsistent data in the database. Pretty much the only choice is to back out and try again.

To cancel the transaction and roll back all the proposed changes, you can use the **ROLLBACK** command. Again, the keyword **TRANSACTION** is optional:

```
ROLLBACK [TRANSACTION]
```

ROLLBACK will undo and revert all the proposed changes made by the current transaction and then close the transaction. It does not necessarily return the database to its prior state, as other clients may have been making changes in parallel. A ROLLBACK only cancels the proposed changes made by this client within the current transaction.

Both COMMIT and ROLLBACK will end the current transaction, putting SQLite back into autocommit mode.

## Save-Points

In addition to ACID-compliant transactions, SQLite also supports *save-points*. Save-points allow you to mark specific points in the transaction. You can then accept or rollback to individual save-points without having to commit or rollback an entire transaction. Unlike transactions, you can have more than one save-point active at the same time. Save-points are sometimes called *nested transactions*.

Save-points are generally used in conjunction with large, multistep transactions, where some of the steps or sub-procedures require rollback ability. Save-points allow a transaction to proceed and (if required) roll back one step at a time. They also allow an application to explore different avenues, attempting one procedure, and if that doesn't work, trying another, without having to roll back the entire transaction to start over. In a sense, save-points can be thought of as “undo” markers in SQL command stream.

You can create a save-point with the SAVEPOINT command. Since multiple save-points can be defined, you must provide a name to identify the save-point:

```
SAVEPOINT savepoint_name
```

Save-points act as a stack. Whenever you create a new one, it is put at the top of the stack. Save-point identifiers do not need to be unique. If the same save-point identifier is used more than once, the one nearest to the top of the stack is used.

To release a save-point and accept all of the proposed changes made since the save-point was set, use the RELEASE command:

```
RELEASE [SAVEPOINT] savepoint_name
```

The RELEASE command does not commit any changes to disk. Rather, it flattens all of the changes in the save-point stack into the layer below the named save-point. The save-point is then removed. Any save-points contained by the named save-point are automatically released.

To cancel a set of commands and undo everything back to where a save-point was set, use the ROLLBACK TO command:

```
ROLLBACK [TRANSACTION] TO [SAVEPOINT] savepoint_name
```

Unlike a transaction `ROLLBACK`, a save-point `ROLLBACK TO` does not close out and eliminate the save-point. `ROLLBACK TO` rolls back and cancels any changes issued since the save-point was established, but leaves the transaction state exactly as it was *after* the `SAVEPOINT` command was issued.

Consider the following series of SQL statements. The indentation is used to show the save-point stack:

```
CREATE TABLE t (i);
BEGIN;
  INSERT INTO t (i) VALUES 1;
  SAVEPOINT aaa;
    INSERT INTO t (i) VALUES 2;
    SAVEPOINT bbb;
      INSERT INTO t (i) VALUES 3;
```

At this point, if the command `ROLLBACK TO bbb` is issued, the state of the database would be as if the following commands were entered:

```
CREATE TABLE t (i);
BEGIN;
  INSERT INTO t (i) VALUES 1;
  SAVEPOINT aaa;
    INSERT INTO t (i) VALUES 2;
    SAVEPOINT bbb;
```

Again, notice that rolling back to save-point `bbb` still leaves the save-point in place. Any new commands will be associated with `SAVEPOINT bbb`. For example:

```
CREATE TABLE t (i);
BEGIN;
  INSERT INTO t (i) VALUES 1;
  SAVEPOINT aaa;
    INSERT INTO t (i) VALUES 2;
    SAVEPOINT bbb;
      DELETE FROM t WHERE i=1;
```

Continuing, if the command `RELEASE aaa` was issued, we would get the equivalent of:

```
CREATE TABLE t (i);
BEGIN;
  INSERT INTO t (i) VALUES 1;
  INSERT INTO t (i) VALUES 2;
  DELETE FROM t WHERE i=1;
```

In this case, the proposed changes from both the `aaa` and the enclosed `bbb` save-points were released and merged outward. The transaction is still open, however, and a `COMMIT` would still be required to make the proposed changes permanent.

Even if you have open save-points, you can still issue transaction commands. If the enclosing transaction is committed, all outstanding save-points will automatically be released and then committed. If the transaction is rolled back, all the save-points are rolled back.

If the `SAVEPOINT` command is issued when SQLite is in autocommit mode—that is, outside of a transaction—then a standard autocommit `BEGIN DEFERRED TRANSACTION` will be started. However, unlike with most commands, the autocommit transaction will not automatically commit after the `SAVEPOINT` command returns, leaving the system inside an open transaction. The automatic transaction will remain active until the original save-point is released, or the outer transaction is either explicitly committed or rolled back. This is the only situation when a save-point `RELEASE` will have a direct effect on the enclosing transaction. As with other save-points, if an autocommit save-point is rolled back, the transaction will remain open and the original save-point will be open, but empty.

## System Catalogs

Many relational database systems, including SQLite, keep system state data in a series of data structures known as *system catalogs*. All of the SQLite system catalogs start with the prefix `sqlite_`. Although many of these catalogs contain internal data, they can be queried, using `SELECT`, just as if they were standard tables. Most system catalogs are read-only. If you encounter an unknown database and you're not sure what's in it, examining the system catalogs is a good place to start.

All nontemporary SQLite databases have an `sqlite_master` catalog. This is the master record of all database objects. If any of the tables has a populated `AUTOINCREMENT` column, the database will also have an `sqlite_sequence` catalog. This catalog is used to keep track of the next valid sequence value (for more information on `AUTOINCREMENT`, see “[Primary keys](#)” on page 40). If the SQL command `ANALYZE` has been used, it will also generate one or more `sqlite_stat#` tables, such as `sqlite_stat1` and `sqlite_stat2`. These tables hold various statistics about the values and distributions in various indexes, and are used to help the query optimizer pick the more efficient query solution. For more information, see `ANALYZE` in [Appendix C](#).

The most important of these system catalogs is the `sqlite_master` table. This catalog contains information on all the objects within a database, including the SQL used to define them. The `sqlite_master` table has five columns:

Column name	Column type	Meaning
<code>type</code>	Text	Type of database object
<code>name</code>	Text	Identifier name of object
<code>tbl_name</code>	Text	Name of associated table
<code>rootpage</code>	Integer	Internal use only
<code>sql</code>	Text	SQL used to define object

The `type` column can be `table` (including virtual tables), `index`, `view`, or `trigger`. The `name` column gives the name of the object itself, while the `tbl_name` column gives the name of the table or view the object is associated with. For tables and views, the `tbl_name` is just a copy of the `name` column. The final `sql` column holds a full copy of the original SQL command used to define the object, such as a `CREATE TABLE` or `CREATE TRIGGER` command.

Temporary databases do not have an `sqlite_master` system catalog. Rather, they have an `sqlite_temp_master` table instead.

## Wrap-up

This is a long chapter packed with a huge amount of information. Even if you're familiar with a number of traditional programming languages, the declarative nature of SQL often takes time to wrap your head around. One of the best ways to learn SQL is to simply experiment. SQLite makes it easy to open up a test database, create some tables, and try things out. If you're having problems understanding the details of a command, be sure to look it up in [Appendix C](#). In addition to more detailed descriptions, [Appendix C](#) contains detailed syntax diagrams .

If you wish to make a deeper study into SQL, there are literally hundreds of books to choose from. O'Reilly alone publishes a dozen or so titles just on the SQL language. While there are some differences between the SQL supported by SQLite and other major database systems, SQLite follows the standard fairly closely. Most of the time, SQLite deviates from the standard, it does so in an attempt to support common notations or usage in other popular database products. If you're working on wrapping you're head around some of the higher level concepts, or basic query structures, a tutorial or book written for just about any database product is likely to help. There might be a small bit of tweaking to get the queries to run under SQLite, but the changes are usually minimal.

Popular O'Reilly books covering the SQL language include *Learning SQL* (Beaulieu), *SQL in a Nutshell* (Kline, Kline, Hunt), and the *SQL Cookbook* (Molinaro). More advanced discussions can be found in *The Art of SQL* (Faroult, Robson). Popular reference books also include *SQL For Smarties* (Celko, Morgan Kaufmann) and *Introduction to SQL* (van der Lans, Addison Wesley). These two are large, but very complete. There is also *The SQL Guide to SQLite* (van der Lans, lulu.com), which takes a much deeper look at the SQL dialect specifically used by SQLite.

There are also thousands of websites and online tutorials, communities, and forums, including the SQLite mailing lists, where you can often get insightful answers to intelligent questions.



Before trying too much, be sure to read the next chapter. The next chapter is devoted to the `SELECT` command. In addition to covering the syntax of the command, it dives a bit deeper into what is going on behind the scenes. That foundation knowledge should make it much easier to break down and understand complex queries. It should also make it much easier to write them.



# The SELECT Command

The **SELECT** command is used to extract data from the database. Any time you want to query or return user data stored in a database table, you'll need to use the **SELECT** command.

In terms of both syntax and functionality, **SELECT** is the most complex SQL command. In most applications, it is also one of the most frequently used commands. If you want to get the most out of your database (and your database designs), you'll need a solid understanding of how to properly use **SELECT**.

Generally, the returned values are derived from the contents of the database, but **SELECT** can also be used to return the value of simple expressions. **SELECT** is a read-only command, and will not modify the database (unless the **SELECT** is embedded in a different command, such as **INSERT INTO...SELECT**).

## SQL Tables

The main SQL data structure is the table. Tables are used for both storage and for data manipulation. We've seen how to define tables with the **CREATE TABLE** command, but let's look at some of the details.

A table consists of a heading and a body. The heading defines the name and type (in SQLite, the affinity) of each column. Column names must be unique within the table. The heading also defines the order of the columns, which is fixed as part of the table definition.

The table body contains all of the rows. Each row consists of one data element for each column. All of the rows in a table must have the same number of data elements, one for each column. Each element can hold exactly one data value (or a **NULL**).

SQL tables are allowed to hold duplicate rows. Tables can contain multiple rows where every user-defined column has an equivalent corresponding value. Duplicate rows are normally undesirable in practice, but they are allowed.

The rows in an SQL table are unordered. When a table is displayed or written down, it will have some inherent ordering, but conceptually tables have no ordering. The order of insertion has no meaning to the database.

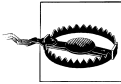

The rows of an SQL table have no defined order.

A very common mistake is to assume a given query will always return rows in the same order. Unless you've specifically asked a query to sort the returned rows in a specific order, there is no guarantee the rows will continue to come back in the same order. Don't let your application code become dependent on the natural ordering of an unordered query. A different version of SQLite may optimize the query differently, resulting in a different row ordering. Even something as simple as adding or dropping an index can alter the row ordering of an unsorted result.

To verify your code is making no assumptions about row order, you can turn on `PRAGMA reverse_unordered_selects`. This will cause SQLite to reverse the natural row ordering of any `SELECT` statement that does not have an explicit order (an `ORDER BY` clause). See [reverse\\_unordered\\_selects](#) in [Appendix F](#) for more details.

## The SELECT Pipeline

The `SELECT` syntax tries to represent a generic framework that is capable of expressing many different types of queries. To achieve this, `SELECT` has a large number of optional clauses, each with its own set of options and formats.

The most general format of a standalone SQLite `SELECT` statement looks like this:

```
SELECT [DISTINCT] select_heading
      FROM source_tables
      WHERE filter_expression
      GROUP BY grouping_expressions
             HAVING filter_expression
      ORDER BY ordering_expressions
      LIMIT count
      OFFSET count
```

Every `SELECT` command must have a select heading, which defines the returned values. Each additional line (`FROM`, `WHERE`, `GROUP BY`, etc.) represents an optional clause.

Each clause represents a step in the `SELECT` pipeline. Conceptually, the result of a `SELECT` statement is calculated by generating a working table, and then passing that table through the pipeline. Each step takes the working table as input, performs a specific operation or manipulation, and passes the modified table on to the next step. Manipulations operate the whole working table, similar to vector or matrix operations.

Practically, the database engine takes a few shortcuts and makes plenty of optimizations when processing a query, but the end result should always match what you would get from independently going through each step, one at a time.

The clauses in a `SELECT` statement are not evaluated in the same order they are written. Rather, their evaluation order looks something like this:

1. `FROM source_tables`  
Designates one or more source tables and combines them together into one large working table.
2. `WHERE filter_expression`  
Filters specific rows out of the working table.
3. `GROUP BY grouping_expressions`  
Groups sets of rows in the working table based off similar values.
4. `SELECT select_heading`  
Defines the result set columns and (if applicable) grouping aggregates.
5. `HAVING filter_expression`  
Filters specific rows out of the grouped table. Requires a `GROUP BY`.
6. `DISTINCT`  
Eliminates duplicate rows.
7. `ORDER BY ordering_expressions`  
Sorts the rows of the result set.
8. `OFFSET count`  
Skips over rows at the beginning of the result set. Requires a `LIMIT`.
9. `LIMIT count`  
Limits the result set output to a specific number of rows.

No matter how large or complex a `SELECT` statement may be, they all follow this basic pattern. To understand how any query works, break it down and look at each individual step. Make sure you understand what the working table looks like before each step, how that step manipulates and modifies the table, and what the working table looks like when it is passed to the next step.

## FROM Clause

The `FROM` clause takes one or more source tables from the database and combines them into one large table. Source tables are usually named tables from the database, but they can also be views or subqueries (see “[Subqueries](#)” on page 76 for more details on subqueries).

Tables are combined using the JOIN operator. Each JOIN combines two tables into a larger table. Three or more tables can be joined together by stringing a series of JOIN operators together. JOIN operators are evaluated left-to-right, but there are several different types of joins, and not all of them are commutative or associative. This makes the ordering and grouping very important. If necessary, parentheses can be used to group the joins correctly.

Joins are *the* most important and most powerful database operator. Joins are the only way to bring together information stored in different tables. As we'll see in the next chapter, nearly all of database design theory assumes the user is comfortable with joins. If you can master joins, you'll be well on your way to mastering relational databases.

SQL defines three major types of joins: the CROSS JOIN, the INNER JOIN, and the OUTER JOIN.

### CROSS JOIN

A CROSS JOIN matches every row of the first table with every row of the second table. If the input tables have  $x$  and  $y$  columns, respectively, the resulting table will have  $x+y$  columns. If the input tables have  $n$  and  $m$  rows, respectively, the resulting table will have  $n \cdot m$  rows. In mathematics, a CROSS JOIN is known as a Cartesian product.

The syntax for a CROSS JOIN is quite simple:

```
SELECT ... FROM t1 CROSS JOIN t2 ...
```

Figure 5-1 shows how a CROSS JOIN is calculated.

Because CROSS JOINS have the potential to generate extremely large tables, care must be taken to only use them when appropriate.

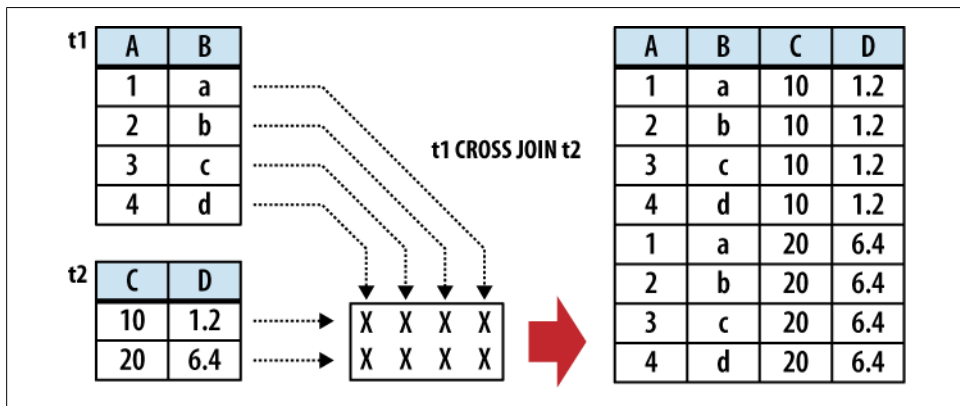

Figure 5-1. In a CROSS JOIN, each row from the first table is matched to each row in the second table.

## INNER JOIN

An `INNER JOIN` is very similar to a `CROSS JOIN`, but it has a built-in condition that is used to limit the number of rows in the resulting table. The conditional is normally used to pair up or match rows from the two source tables. An `INNER JOIN` without any type of conditional expression (or one that always evaluates to true) will result in a `CROSS JOIN`. If the input tables have  $x$  and  $y$  columns, respectively, the resulting table will have no more than  $x+y$  columns (in some cases, it can have fewer). If the input tables have  $n$  and  $m$  rows, respectively, the resulting table can have anywhere from zero to  $n \cdot m$  rows, depending on the condition. An `INNER JOIN` is the most common type of join, and is the default type of join. This makes the `INNER` keyword optional.

There are three primary ways to specify the conditional. The first is with an `ON` expression. This provides a simple expression that is evaluated for each potential row. Only those rows that evaluate to true are actually joined. A `JOIN...ON` looks like this:

```
SELECT ... FROM t1 JOIN t2 ON conditional_expression ...
```

An example of this is shown in [Figure 5-2](#).

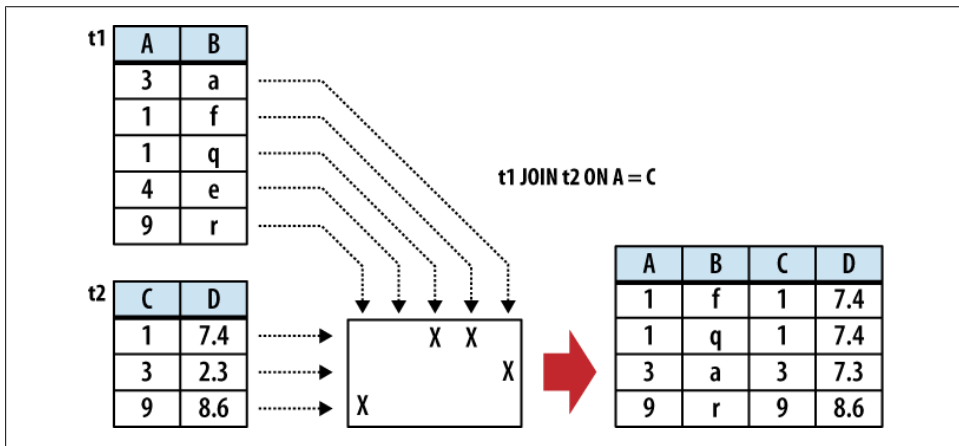

Figure 5-2. In an `INNER JOIN`, the rows are matched based off a condition.

If the input tables have  $C$  and  $D$  columns, respectively, a `JOIN...ON` will always result in  $C+D$  columns.

The conditional expression can be used to test for anything, but the most common type of expression tests for equality between similar columns in both tables. For example, in a business employee database, there is likely to be an `employee` table that contains (among other things) a `name` column and an `eid` column (employee ID number). Any other table that needs to associate rows to a specific employee will also have an `eid` column that acts as a pointer or reference to the correct employee. This relationship makes it very common to have queries with `ON` expressions similar to:

```
SELECT ... FROM employee JOIN resource ON employee.eid = resource.eid ...
```

This query will result in an output table where the rows from the `resource` table are correctly matched to their corresponding rows in the `employee` table.

This `JOIN` has two issues. First, that `ON` condition is a lot to type out for something so common. Second, the resulting table will have two `eid` columns, but for any given row, the values of those two columns will always be identical. To avoid redundancy and keep the phrasing shorter, inner join conditions can be declared with a `USING` expression. This expression specifies a list of one or more columns:

```
SELECT ... FROM t1 JOIN t2 USING ( col1 ,... ) ...
```

Queries from the `employee` database would now look something like this:

```
SELECT ... FROM employee JOIN resource USING ( eid ) ...
```

To appear in a `USING` condition, the column name must exist in both tables. For each listed column name, the `USING` condition will test for equality between the pairs of columns. The resulting table will have only one instance of each listed column.

If this wasn't concise enough, SQL provides an additional shortcut. A `NATURAL JOIN` is similar to a `JOIN...USING`, only it automatically tests for equality between the values of every column that exists in both tables:

```
SELECT ... FROM t1 NATURAL JOIN t2 ...
```

If the input tables have  $x$  and  $y$  columns, respectively, a `JOIN...USING` or a `NATURAL JOIN` will result in anywhere from  $\max(x,y)$  to  $x+y$  columns.

Assuming `eid` is the only column identifier to appear in both the `employee` and `resource` table, our business query becomes extremely simple:

```
SELECT ... FROM employee NATURAL JOIN resource ...
```

`NATURAL JOINS` are convenient, as they are very concise, and allow changes to the key structure of various tables without having to update all of the corresponding queries. They can also be a tad dangerous unless you follow some discipline in naming your columns. Because none of the columns are explicitly named, there is no error checking in the sanity of the join. For example, if no matching columns are found, the `JOIN` will automatically (and without warning) degrade to a `CROSS JOIN`, just like any other `INNER JOIN`. Similarly, if two columns accidentally end up with the same name, a `NATURAL JOIN` will automatically include them in the join condition, if you wanted it or not.

## OUTER JOIN

The `OUTER JOIN` is an extension of the `INNER JOIN`. The SQL standard defines three types of `OUTER JOINS`: `LEFT`, `RIGHT`, and `FULL`. Currently, SQLite only supports the `LEFT OUTER JOIN`.

`OUTER JOINS` have a conditional that is identical to `INNER JOINS`, expressed using an `ON`, `USING`, or `NATURAL` keyword. The initial results table is calculated the same way. Once the primary `JOIN` is calculated, an `OUTER` join will take any unjoined rows from one or



both tables, pad them out with NULLs, and append them to the resulting table. In the case of a `LEFT OUTER JOIN`, this is done with any unmatched rows from the first table (the table that appears to the left of the word `JOIN`).

Figure 5-3 shows an example of a `LEFT OUTER JOIN`.

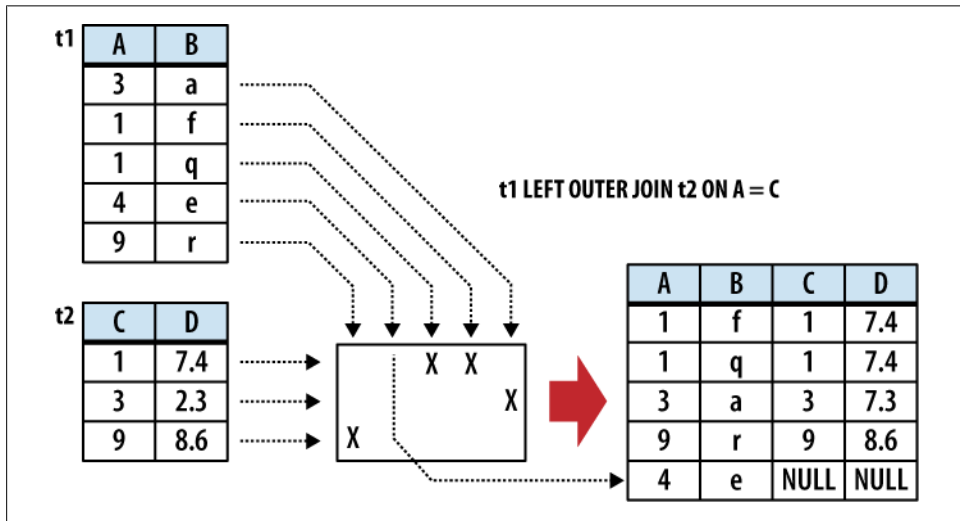

Figure 5-3. An `OUTER JOIN` is just like an `INNER JOIN`, only unmatched rows are included in the results table. This shows a `LEFT OUTER JOIN`, where unmatched rows from the left (`t1`) table are added to the results.

The result of a `LEFT OUTER JOIN` will contain at least one instance of every row from the lefthand table. If the input tables have  $x$  and  $y$  columns, respectively, the resulting table will have no more than  $x+y$  columns (the exact number depends on which conditional is used). If the input tables have  $n$  and  $m$  rows, respectively, the resulting table can have anywhere from  $n$  to  $n \cdot m$  rows.

Because they include unmatched rows, `OUTER JOINS` are often specifically used to search for unresolved or “dangling” rows.

### Table aliases

Because the `JOIN` operator combines the columns of different tables into one, larger table, there may be cases when the resulting working table has multiple columns with the same name. To avoid ambiguity, any part of the `SELECT` statement can qualify any column reference with a source-table name. However, there are some cases when this is still not enough. For example, there are some situations when you need to join a table to itself, resulting in the working table having two instances of the same source-table. Not only does this make every column name ambiguous, it makes it impossible to distinguish them using the source-table name. Another problem is with subqueries, as they don’t have concrete source-table names.

To avoid ambiguity within the `SELECT` statement, any instance of a source-table, view, or subquery can be assigned an alias. This is done with the `AS` keyword. For example, in the cause of a self-join, we can assign a unique alias for each instance of the same table:

```
SELECT ... FROM x AS x1 JOIN x AS x2 ON x1.col1 = x2.col2 ...
```

Or, in the case of a subquery:

```
SELECT ... FROM ( SELECT ... ) AS sub ...
```

Technically, the `AS` keyword is optional, and each source-table name can simply be followed with an alias name. This can be quite confusing, however, so it is recommended you use the `AS` keyword.

If any of the subquery columns conflict with a column from a standard source table, you can now use the `sub` qualifier as a table name. For example, `sub.col1`.

Once a table alias has been assigned, the original source-table name becomes invalid and cannot be used as a column qualifier. You must use the alias instead.

## WHERE Clause

The `WHERE` clause is used to filter rows from the working table generated by the `FROM` clause. It is very similar to the `WHERE` clause found in the `UPDATE` and `DELETE` commands. An expression is provided that is evaluated for each row. Any row that causes the expression to evaluate to false or `NULL` is discarded. The resulting table will have the same number of columns as the original table, but may have fewer rows. It is not considered an error if the `WHERE` clause eliminates every row in the working table. [Figure 5-4](#) shows how the `WHERE` clause works.

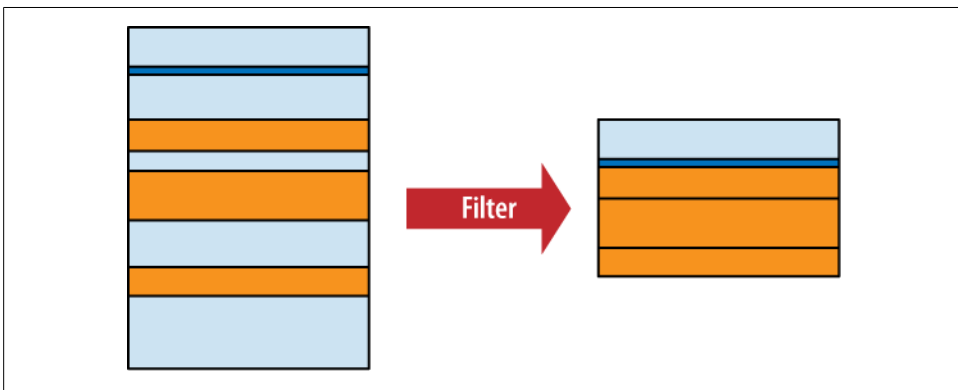

Figure 5-4. The `WHERE` clause filters rows based off a filter expression.

Some `WHERE` clauses can get quite complex, resulting in a long series of `AND` operators used to join sub-expressions together. Most filter for a specific row, however, searching for a specific key value.

## GROUP BY Clause

The `GROUP BY` clause is used to collapse, or “flatten,” groups of rows. Groups can be counted, averaged, or otherwise aggregated together. If you need to perform any kind of inter-row operation that requires data from more than one row, chances are you’ll need a `GROUP BY`.

The `GROUP BY` clause provides a list of grouping expressions and optional collations. Very often the expressions are simple column references, but they can be arbitrary expressions. The syntax looks like this:

```
GROUP BY grouping_expression [COLLATE collation_name] [,...]
```

The grouping process has two steps. First, the `GROUP BY` expression list is used to arrange table rows into different groups. Once the groups are defined, the `SELECT` header (discussed in the next section) defines how those groups are flattened down into a single row. The resulting table will have one row for each group.

To split up the working table into groups, the list of expressions is evaluated across each row of the table. All of the rows that produce equivalent values are grouped together. An optional collation can be given with each expression. If the grouping expression involves text values, the collation is used to determine which values are equivalent. For more information on collations, see “[ORDER BY Clause](#)” on page 74.

Figure 5-5 shows how the rows are grouped together with the `GROUP BY` clause.

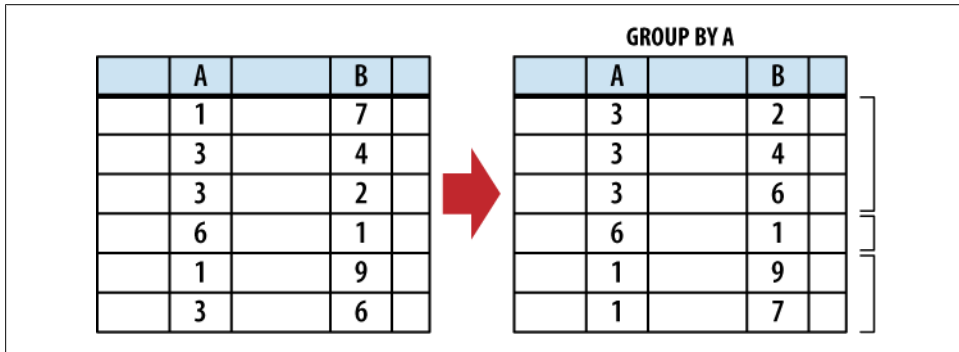

Figure 5-5. The `GROUP BY` clause groups rows based off a list of grouping expressions.

Once grouped together, each collection of rows is collapsed into a single row. This is typically done using aggregate functions that are defined in the `SELECT` heading, which is described in the next section, on page 70.

Because it is common to `GROUP BY` using expressions that are defined in the `SELECT` header, it is possible to simply reference `SELECT` heading expressions in the `GROUP BY` expression list. If a `GROUP BY` expression is given as a literal integer, that number is used as a column index in the result table defined by the `SELECT` header. Indexes start at one

with the leftmost column. A **GROUP BY** expression can also reference a result column alias. Result column aliases are explained in the next section.

## SELECT Header

The **SELECT** header is used to define the format and content of the final result table. Any column you want to appear in the final results table must be defined by an expression in the **SELECT** header. The **SELECT** heading is the only required step in the **SELECT** command pipeline.

The format of the header is fairly simple, consisting of a list of expressions. Each expression is evaluated in the context of each row, producing the final results table. Very often the expressions are simple column references, but they can be any arbitrary expression involving column references, literal values, or SQL functions. To generate the final query result, the list of expressions is evaluated once for each row in the working table.

Additionally, you can provide a column name using the **AS** keyword:

```
SELECT expression [AS column_name] [,...]
```

Don't confuse the **AS** keyword used in the **SELECT** header with the one used in the **FROM** clause. The **SELECT** header uses the **AS** keyword to assign a column name to one of the output columns, while the **FROM** clauses uses the **AS** keyword to assign a source-table alias.

Providing an output column name is optional, but recommended. The column name assigned to a results table is not strictly defined unless the user provides an **AS** column alias. If your application searches for a specific column name in the query results, be sure to assign a known name using **AS**. Assigning a column name will also allow other parts of the **SELECT** statement to reference an output column by name. Steps in the **SELECT** pipeline that are processed before the **SELECT** header, such as the **WHERE** and **GROUP BY** clause, can also reference output columns by name, just as long as the column expression does not contain an aggregate function.

If there is no working table (no **FROM** clause), the expression list is evaluated a single time, producing a single row. This row is then used as the working table. This is useful to test and evaluate standalone expressions.

Although the **SELECT** header appears to filter columns from the working table, much like the **WHERE** clause filters rows, this isn't exactly correct. All of the columns from the original working table are still available to clauses that are processed after the **SELECT** header. For example, it is possible to sort the results (via **ORDER BY**, which is processed after the **SELECT** header) using a column that doesn't appear in the query output.

It would be more accurate to say that the **SELECT** header tags specific columns for output. Not until the whole **SELECT** pipeline has been processed and the results are ready to be returned, are the unused columns stripped out. [Figure 5-6](#) illustrates this point.

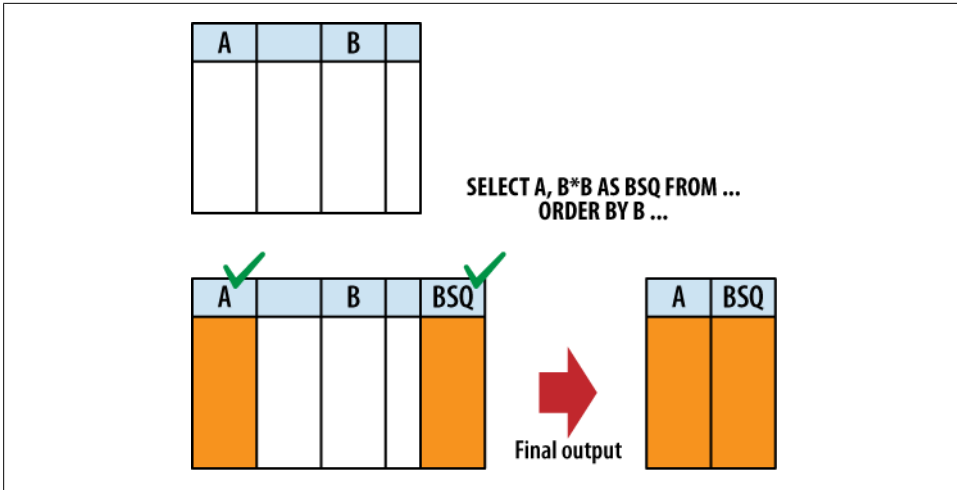

Figure 5-6. The `SELECT` heading tags specific columns for output. The unused columns are not removed until the query result is actually returned. Later `SELECT` clauses (such as `ORDER BY`) still have access to columns that are not part of the query result.

In addition to the standard expressions, `SELECT` supports two wildcards. A simple asterisk (\*) will cause every user-defined column from every source table in the `FROM` clause to be output. You can also target a specific table (or table alias) using the format `table_name.*`. Although both of these wildcards are capable of returning more than one column, they can be mixed along with other expressions in the expression list. Wildcards cannot use a column alias, since they often return more than one column.

Be aware that the `SELECT` wildcards will not return any automatically generated `ROWID` columns. To return both the `ROWID` and the user-defined columns, simply ask for them both:

```
SELECT ROWID, * FROM table;
```

Wildcards do include any user-defined `INTEGER PRIMARY KEY` column that have replaced the standard `ROWID` column. See “[Primary keys](#)” on page 40 for more information about how `ROWID` and `INTEGER PRIMARY KEY` columns interact.

In addition to determining the columns of the query result, the `SELECT` header determines how row-groups (produced by the `GROUP BY` clause) are flattened into a single row. This is done using *aggregate functions*. An aggregate function takes a column expression as input and aggregates, or combines, all of the column values from the rows of a group and produces a single output value. Common aggregate functions include `count()`, `min()`, `max()`, and `avg()`. [Appendix E](#) provides a full list of all the built-in aggregate functions.

Any column or expression that is not passed through an aggregate function will assume whatever value was contained in the last row of the group. However, because SQL tables are unordered, and because the `SELECT` header is processed before the `ORDER BY`

clause, we don't really know which row is "last." This means the values for any unaggregated output will be taken from some essentially random row in the group. [Figure 5-7](#) shows how this works.

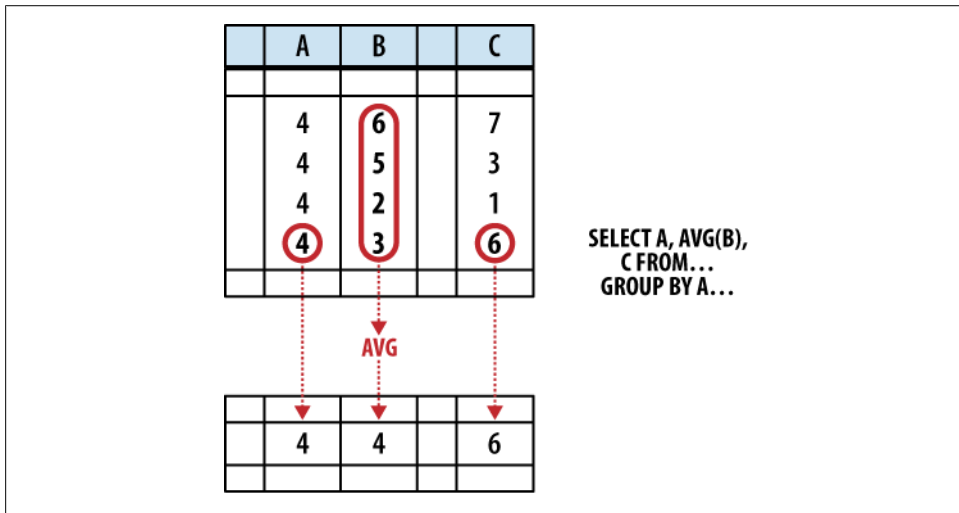

*Figure 5-7. The SELECT header will flatten any row groups created by GROUP BY. This figure shows how different columns from one row-group are flattened into an output row. Any value not computed by an aggregate function comes from the last row. Because column A was used as a GROUP BY expression, all the rows are known to have the same value, and it is safe to return. Column B is run through an aggregate function, and is also safe to return. Column C is not safe to return, as the order of the rows within a group is undefined.*

In some cases, picking the value from a random row is not a bad thing. For example, if a SELECT header expression is also used as a GROUP BY expression, then we know that column has an equivalent value in every row of a group. No matter which row you choose, you will always get the same value.

Where you can run into trouble is when the SELECT header uses column references that were not part of the GROUP BY clause, nor were they passed through aggregate functions. In those cases there is no deterministic way to figure out what the output value will be. To avoid this, when using a GROUP BY clause, SELECT header expressions should only use column references as aggregate function inputs, or the header expressions should match those used in the GROUP BY clause.

Here are some examples. In this case all of the expressions are bare column references to help make things clear:

```
SELECT col1, sum( col2 ) FROM tbl GROUP BY col1; -- well formed
```

This is a well formed statement. The GROUP BY clause shows that the rows are being grouped based off the values in col1. That makes it safe for col1 to appear in the SELECT header, since every row in a particular group will have an equivalent value in

col1. The `SELECT` header also references col2, but it is fed into an aggregate function. The aggregate function will take all of the col2 values from different rows in the group and produce a logical answer—in this case, a numerical summation.

The result of this statement will be two columns. The first column will have one row for each unique value from col1. Each row of the second column will have the sum of all the values in col2 that are associated with the col1 value listed in the first result column. More detailed examples can be found at the end of the chapter.

This next statement is not well formed:

```
SELECT col1, col2 FROM tbl GROUP BY col1; -- NOT well formed
```

As before, the rows are grouped based off the value in col1, which makes it safe for col1 to appear in the `SELECT` header. The column col2 appears bare, however, and not as an aggregate parameter. When this statement is run, the second return column will contain random values from the original col2 column.

Although every row within a group should have an equivalent value in a column or expression that was used as a grouping key, that doesn't always mean the values are the exact same. If a collation such as `NOCASE` was used, different values (such as 'ABC' and 'abc') are considered equivalent. In these cases, there is no way to know the specific value that will be returned from a `SELECT` header. For example:

```
CREATE TABLE tbl ( t );
INSERT INTO tbl VALUES ( 'ABC' );
INSERT INTO tbl VALUES ( 'abc' );
SELECT t FROM tbl GROUP BY t COLLATE NOCASE;
```

This query will only return one row, but there is no way to know which specific value will be returned.

Finally, if the `SELECT` header contains an aggregate function, but the `SELECT` statement has no `GROUP BY` clause, the entire working table is treated as a single group. Since flattened groups always return one row, this will cause the query to return only one row—even if the working table contained no rows.

## HAVING Clause

Functionally, the `HAVING` clause is identical to the `WHERE` clause. The `HAVING` clause consists of a filter expression that is evaluated for each row of the working table. Any row that evaluates to false or `NULL` is filtered out and removed. The resulting table will have the same number of columns, but may have fewer rows.

The main difference between the `WHERE` clause and the `HAVING` clause is where they appear in the `SELECT` pipeline. The `HAVING` clause is processed after the `GROUP BY` and `SELECT` clauses, allowing `HAVING` to filter rows based off the results of any `GROUP BY` aggregate. `HAVING` clauses can even have their own aggregates, allowing them to filter on aggregate results that are not part of the `SELECT` header.

HAVING clauses should only contain filter expressions that depend on the GROUP BY output. All other filtering should be done in the WHERE clause.

Both the HAVING and WHERE clauses can reference result column names defined in the SELECT header with the AS keyword. The main difference is that the WHERE clause can only reference expressions that do not contain aggregate functions, while the HAVING clause can reference any result column.

## DISTINCT Keyword

The DISTINCT keyword will scan the result set and eliminate any duplicate rows. This ensures the returned rows constitute a proper set. Only the columns and values specified in the SELECT header are considered when determining if a row is a duplicate or not. This is one of the few cases when NULLs are considered to have “equality,” and will be eliminated.

Because SELECT DISTINCT must compare every row against every other row, it is an expensive operation. In a well-designed database, it is also rarely required. Therefore, its usage is somewhat unusual.

## ORDER BY Clause

The ORDER BY clause is used to sort, or order, the rows of the results table. A list of one or more sort expressions is provided. The first expression is used to sort the table. The second expression is used to sort any equivalent rows from the first sort, and so on. Each expression can be sorted in ascending or descending order.

The basic format of the ORDER BY clause looks like this:

```
ORDER BY expression [COLLATE collation_name] [ASC|DESC] [,...]
```

The expression is evaluated for each row. Very often the expression is a simple column reference, but it can be any expression. The resulting value is then compared against those values generated by other rows. If given, the named collation is used to sort the values. A collation defines a specific sorting order for text values. The ASC or DESC keywords can be used to force the sort in an ascending or descending order. By default, values are sorted in an ascending order using the default collation.

An ORDER BY expression can utilize any source column, including those that do not appear in the query result. Like GROUP BY, if an ORDER BY expression consists of a literal integer, it is assumed to be a column index. Column indexes start on the left with 1, so the phrase ORDER BY 2 will sort the results table by its second column.

Because SQLite allows different datatypes to be stored in the same column, sorting can get a bit more interesting. When a mixed-type column is sorted, NULLs will be sorted to the top. Next, integer and real values will be mixed together in proper numeric order. The numbers will be followed by text values, with BLOB values at the end. There will



be no attempt to convert types. For example, a text value holding a string representation of a number will be sorted in with the other text values, and not with the numeric values.

In the case of numeric values, the natural sort order is well defined. Text values are sorted by the active collation, while BLOB values are always sorted using the **BINARY** collation. SQLite comes with three built-in collation functions. You can also use the API to define your own collation functions. The three built-in collations are:

#### **BINARY**

Text values are sorted according to the semantics of the POSIX `memcmp()` call. The encoding of a text value is *not* taken into account, essentially treating it as a large binary string. BLOB values are always sorted with this collation. This is the default collation.

#### **NOCASE**

Same as **BINARY**, only ASCII uppercase characters are converted to lowercase before the comparison is done. The case-conversion is strictly done on 7-bit ASCII values. The normal SQLite distribution does not support UTF-aware collations.

#### **RTRIM**

Same as **BINARY**, only trailing (righthand) whitespace is ignored.

While **ORDER BY** is extremely useful, it should only be used when it is actually needed—especially with very large result tables. Although SQLite can sometimes make use of an index to calculate the query results in order, in many cases SQLite must first calculate the entire result set and then sort it, before rows are returned. In that case, the intermediate results table must be held in memory or on disk until it is fully computed and can then be sorted.

Overall, there are plenty of situations where **ORDER BY** is justified, if not required. Just be aware there can be some significant costs involved in its use, and you shouldn't get in the habit of tacking it on to every query “just because.”

## **LIMIT and OFFSET Clauses**

The **LIMIT** and **OFFSET** clauses allow you to extract a specific subset of rows from the final results table. **LIMIT** defines the maximum number of rows that will be returned, while **OFFSET** defines the number of rows to skip before returning the first row. If no **OFFSET** is provided, the **LIMIT** is applied to the top of the table. If a negative **LIMIT** is provided, the **LIMIT** is removed and will return the whole table.

There are three ways to define a **LIMIT** and **OFFSET**:

```
LIMIT limit_count
LIMIT limit_count OFFSET offset_count
LIMIT offset_count, limit_count
```



Note that if both a limit and offset are given using the third format, the order of the numbers is reversed.

Here are some examples. Notice that the `OFFSET` value defines how many rows are skipped, not the position of the first row:

```
LIMIT 10           -- returns the first 10 rows (rows 1 - 10)
LIMIT 10 OFFSET 3  -- returns rows 4 - 13
LIMIT 3  OFFSET 20 -- returns rows 21 - 23
LIMIT 3, 20        -- returns rows 4 - 23 (different from above!)
```

Although it is not strictly required, you usually want to define an `ORDER BY` if you're using a `LIMIT`. Without an `ORDER BY`, there is no well-defined order to the result, making the limit and offset somewhat meaningless.

## Advanced Techniques

Beyond the basic `SELECT` syntax, there are a few advanced techniques for expressing more complex queries.

### Subqueries

The `SELECT` command provides a great deal of flexibility, but there are times when a single `SELECT` command cannot fully express a query. To help with these situations, SQL supports *subqueries*. A subquery is nothing more than a `SELECT` statement that is embedded in another `SELECT` statement. Subqueries are also known as sub-selects.

Subqueries are most commonly found in the `FROM` clause, where they act as a computed source table. This type of subquery can return any number of rows or columns, and is similar to creating a view or running the query, recording the results into a temporary table, and then referencing that table in the main query. The main advantage of using an in-line subquery is that the query optimizer is able to merge the subquery into the main `SELECT` statement and look at the whole problem, often leading to a more efficient query plan.

To use a subquery in the `FROM` clause, simply enclose it in parentheses. The following two statements will produce the same output:

```
SELECT * FROM Tb1A AS a JOIN Tb1B AS b;
SELECT * FROM Tb1A AS a JOIN (SELECT * FROM Tb1B) AS b;
```

Subqueries can show up in other places, including general expressions used in any SQL command. The `EXISTS` and `IN` operators both utilize subqueries. In fact, you can use a subquery any place an expression expects a list of literal values (a subquery cannot be used to generate a list of identifiers, however). See [Appendix D](#) for more details on SQL expressions.

## Compound SELECT Statements

In addition to subqueries, multiple `SELECT` statements can be combined together to form a *compound SELECT*. Compound `SELECT`s use set operators on the rows generated by a series of `SELECT` statements.

In order to combine correctly, each `SELECT` statement must generate the same number of columns. The column names from the first `SELECT` statement will be used for the overall result. Only the last `SELECT` statement can have an `ORDER BY`, `LIMIT` or `OFFSET` clause, which get applied to the full compound result table. The syntax for a compound `SELECT` looks like this:

```
SELECT ... FROM ... WHERE ... GROUP BY ... HAVING ...  
  
compound_operator  
  
SELECT ... FROM ... WHERE ... GROUP BY ... HAVING ...  
  
[...]  
  
ORDER BY ... LIMIT ... OFFSET ...
```

Multiple compound operators can be used to include additional `SELECT` statements.

### UNION ALL

The `UNION ALL` operator concatenates all of the rows returned by each `SELECT` into one large table. If the two `SELECT` blocks generate  $N$  and  $M$  rows, respectively, the resulting table will have  $N+M$  rows.

### UNION

The `UNION` operator is very similar to the `UNION ALL` operator, but it will eliminate any duplicate rows, including duplicates that came from the same `SELECT` block. If the two `SELECT` blocks generate  $N$  and  $M$  rows, respectively, the resulting table can have anywhere from 1 to  $N+M$  rows.

### INTERSECT

The `INTERSECT` operator will return one instance of any row that is found (one or more times) in both `SELECT` blocks. If the two `SELECT` blocks generate  $N$  and  $M$  rows, respectively, the resulting table can have anywhere from 0 to  $\text{MIN}(N,M)$  rows.

### EXCEPT

The `EXCEPT` operator will return all of the rows in the first `SELECT` block that are *not* found in the second `SELECT` block. It is essentially a subtraction operator. If there are duplicate rows in the first block, they will all be eliminated by a single, matching row in the second block. If the two `SELECT` blocks generate  $N$  and  $M$  rows, respectively, the resulting table can have anywhere from 0 to  $N$  rows.

SQLite supports the `UNION`, `UNION ALL`, `INTERSECT`, and `EXCEPT` compound operators. [Figure 5-8](#) shows the result of each operator.

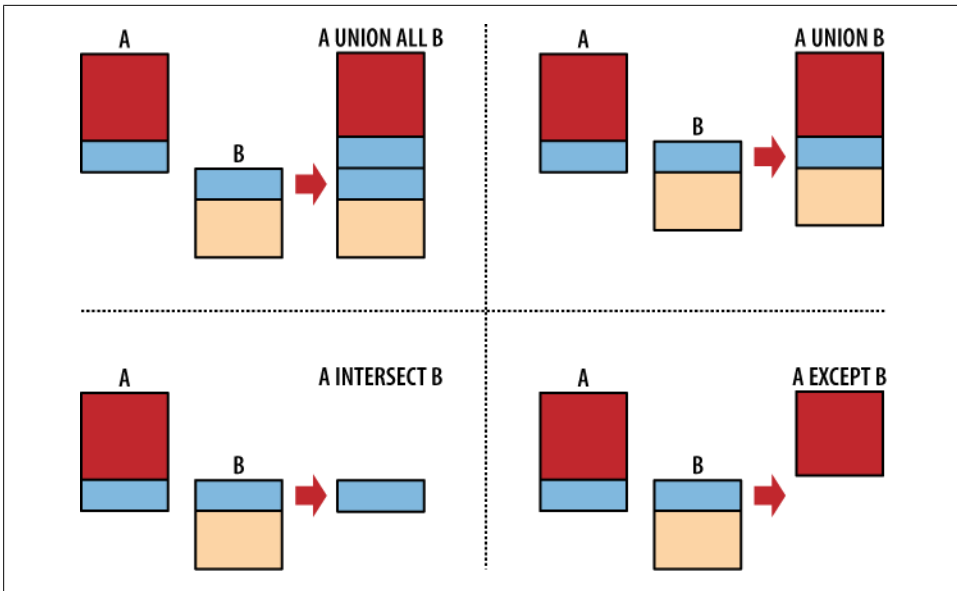

Figure 5-8. The compound operators *UNION ALL*, *UNION*, *INTERSECT* and *EXCEPT*.

Once all the compound operators have been combined, any trailing **ORDER BY**, **LIMIT**, and **OFFSET** is applied to the final result table. In the case of compound **SELECT** statements, the expressions present in any **ORDER BY** clause must be exactly match one of the result columns, or use a column index.

## Alternate JOIN Notation

There are two styles of join notation. The style shown earlier in this chapter is known as *explicit join notation*. It is named such because it uses the keyword **JOIN** to explicitly describe how each table is joined to the next. The explicit join notation is also known as *ANSI join notation*, as it was introduced when SQL went through the standardization process.

The older, original join notation is known as *implicit join notation*. Using this notation, the **FROM** clause is simply a comma-separated list of tables. The tables in the list are combined using a Cartesian product and the relevant rows are extracted with additional **WHERE** conditions. In effect, it degrades every join to a **CROSS JOIN** and then moves the join conditions out of the **FROM** clause and into the **WHERE** clause.

This first statement uses the explicit join notation we learned earlier in the chapter:

```
SELECT ...
  FROM employee JOIN resource ON ( employee.aid = resource.aid )
 WHERE ...
```

This is the same statement written with the implicit join notation:

```
SELECT ...
  FROM employee, resource
 WHERE employee.eid = resource.eid AND ...
```

There is no performance difference between the two notations: it is purely a matter of syntax.

In general, the explicit notion (the first one) has become the standard way of doing things. Most people find the explicit notation easier to read, making the intent of the query more transparent and easier to understand. I've always felt the explicit notation is a bit cleaner, as it puts the complete join specification into the `FROM` clause, leaving the `WHERE` clause free for query-specific filters. Using the explicit notation, the `FROM` clause (and the `FROM` clause alone) fully and independently specifies what you're selecting "from."

The explicit notation also lets you be much more specific about the type and order of each `JOIN`. In SQLite, you must use the explicit notation if you want an `OUTER JOIN`—the implicit notation can only be used to indicate a `CROSS JOIN` or `INNER JOIN`.

If you're learning SQL for the first time, I would strongly suggest you become comfortable with the explicit notation. Just be aware that there is a great deal of SQL code out there (including older books and tutorials) using the older, implicit notation.

## SELECT Examples

The `SELECT` command is very complex, and it can be difficult to see how these different clauses can be fit together into something useful. Some of this will become more obvious in the next chapter, when we look at standard database design practices, but to get you started, we're going to look at several examples.

All of these examples will use this data:

```
CREATE TABLE x ( a, b );
INSERT INTO x VALUES ( 1, 'Alice' );
INSERT INTO x VALUES ( 2, 'Bob' );
INSERT INTO x VALUES ( 3, 'Charlie' );

CREATE TABLE y ( c, d );
INSERT INTO y VALUES ( 1, 3.14159 );
INSERT INTO y VALUES ( 1, 2.71828 );
INSERT INTO y VALUES ( 2, 1.61803 );

CREATE TABLE z ( a, e );
INSERT INTO z VALUES ( 1, 100 );
INSERT INTO z VALUES ( 1, 150 );
INSERT INTO z VALUES ( 3, 300 );
INSERT INTO z VALUES ( 9, 900 );
```

These examples show the `sqlite3` command-line tool. The following dot-commands were issued to make the output easier to understand. The last command will cause `sqlite3` to print the string `[NULL]` whenever a `NULL` is encountered. Normally, a `NULL` will produce a blank output that is indistinguishable from an empty string:

```
.headers on
.mode column
.nullvalue [NULL]
```

This dataset is available on the book's download page on the O'Reilly website, as both an SQL file and an SQLite database. I suggest you sit down with a copy of `sqlite3` and try these commands out. Try experimenting with different variations.

If one of these examples doesn't quite make sense, just break the `SELECT` statement down into its individual parts and step through them bit by bit.

## Simple SELECTs

Let's start with a simple select that returns all of the columns and rows in table `x`. The `SELECT *` syntax returns all columns by default:

```
sqlite> SELECT * FROM x;

a          b
-----
1          Alice
2          Bob
3          Charlie
```

We can also return expressions, rather than just columns:

```
sqlite> SELECT d, d*d AS dSquared FROM y;

d          dSquared
-----
3.14159    9.8695877281
2.71828    7.3890461584
1.61803    2.6180210809
```

## Simple JOINS

Now some joins. By default, the bare keyword `JOIN` indicates an `INNER JOIN`. However, when no additional condition is put on the `JOIN`, it reverts to a `CROSS JOIN`. As a result, all three of these queries produce the same results. The last line uses the implicit join notation.

```

sqlite> SELECT * FROM x JOIN y;
sqlite> SELECT * FROM x CROSS JOIN y;
sqlite> SELECT * FROM x, y;

```

a	b	c	d
1	Alice	1	3.14159
1	Alice	1	2.71828
1	Alice	2	1.61803
2	Bob	1	3.14159
2	Bob	1	2.71828
2	Bob	2	1.61803
3	Charlie	1	3.14159
3	Charlie	1	2.71828
3	Charlie	2	1.61803

In the case of a cross join, every row in table *a* is matched to every row in table *y*. Since both tables had three rows and two columns, the result set has nine rows (3·3) and four columns (2+2).

## JOIN...ON

Next, a fairly simple inner join using a basic *ON* join condition:

```

sqlite> SELECT * FROM x JOIN y ON a = c;

```

a	b	c	d
1	Alice	1	3.14159
1	Alice	1	2.71828
2	Bob	2	1.61803

This query still generates four columns, but only those rows that fulfill the join condition are included in the result set.

The following statement requires the columns to be qualified, since both table *x* and table *z* have an *a* column. Notice that two different *a* columns are returned, one from each source table:

```

sqlite> SELECT * FROM x JOIN z ON x.a = z.a;

```

a	b	a	e
1	Alice	1	100
1	Alice	1	150
3	Charlie	3	300

## JOIN...USING, NATURAL JOIN

If we use a `NATURAL JOIN` or the `USING` syntax, the duplicate column will be eliminated. Since both table `x` and table `z` have only column `a` in common, both of these statements produce the same output:

```
sqlite> SELECT * FROM x JOIN z USING ( a );
sqlite> SELECT * FROM x NATURAL JOIN z;
```

a	b	e
1	Alice	100
1	Alice	150
3	Charlie	300

## OUTER JOIN

A `LEFT OUTER JOIN` will return the same results as an `INNER JOIN`, but will also include rows from table `x` (the left/first table) that were not matched:

```
sqlite> SELECT * FROM x LEFT OUTER JOIN z USING ( a );
```

a	b	e
1	Alice	100
1	Alice	150
2	Bob	[NULL]
3	Charlie	300

In this case, the `Bob` row from table `x` has no matching row in table `z`. Those column values normally provided by table `z` are padded out with `NULL`, and the row is then included in the result set.

## Compound JOIN

It is also possible to `JOIN` multiple tables together. In this case we join table `x` to table `y`, and then join the result to table `z`:

```
sqlite> SELECT * FROM x JOIN y ON x.a = y.c LEFT OUTER JOIN z ON y.c = z.a;
```

a	b	c	d	a	e
1	Alice	1	3.14159	1	100
1	Alice	1	3.14159	1	150
1	Alice	1	2.71828	1	100
1	Alice	1	2.71828	1	150
2	Bob	2	1.61803	[NULL]	[NULL]



If you don't see what is going on here, work through the joins one at a time. First look at what `FROM x JOIN y ON x.a = y.c` will produce (shown in one of the previous examples). Then look at how this result set would combine with table `z` using a `LEFT OUTER JOIN`.

## Self JOIN

Our last join example shows a self-join, where a table is joined against itself. This creates two unique instances of the same table and necessitates the use of table aliases:

```
sqlite> SELECT * FROM x AS x1 JOIN x AS x2 ON x1.a + 1 = x2.a;
```

a	b	a	b
1	Alice	2	Bob
2	Bob	3	Charlie

Also, notice that the join condition is a more arbitrary expression, rather than being a simple test of column references.

## WHERE Examples

Moving on, the `WHERE` clause is used to filter rows. We can pick out a specific row:

```
sqlite> SELECT * FROM x WHERE b = 'Alice';
```

a	b
1	Alice

Or a range of values:

```
sqlite> SELECT * FROM y WHERE d BETWEEN 1.0 AND 3.0;
```

c	d
1	2.71828
2	1.61803

In this case, the `WHERE` expression references the output column by its assigned name:

```
sqlite> SELECT c, d, c+d AS sum FROM y WHERE sum < 4.0;
```

c	d	sum
1	2.71828	3.71828
2	1.61803	3.61803

## GROUP BY Examples

Now let's look at a few GROUP BY statements. Here we group table z by the a column. Since there are three unique values in z.a, the output has three rows. Only the grouping a=1 has more than one row, however. We can see this in the count() values returned by the second column:

```
sqlite> SELECT a, count(a) AS count FROM z GROUP BY a;
```

a	count
1	2
3	1
9	1

This is a similar query, only now the second output column represents the sum of all the z.e values in each group:

```
sqlite> SELECT a, sum(e) AS total FROM z GROUP BY a;
```

a	total
1	250
3	300
9	900

We can even compute our own average and compare that to the avg() aggregate:

```
sqlite> SELECT a, sum(e), count(e),  
...> sum(e)/count(e) AS expr, avg(e) AS agg  
...> FROM z GROUP BY a;
```

a	sum(e)	count(e)	expr	agg
1	250	2	125	125.0
3	300	1	300	300.0
9	900	1	900	900.0

A HAVING clause can be used to filter rows based off the results of the sum() aggregation:

```
sqlite> SELECT a, sum(e) AS total FROM z GROUP BY a HAVING total > 500;
```

a	total
9	900

## ORDER BY Examples

The output can also be sorted. Most of these examples already look sorted, but that's mostly by chance. The `ORDER BY` clause enforced a specific order:

```
sqlite> SELECT * FROM y ORDER BY d;
```

c	d
2	1.61803
1	2.71828
1	3.14159

Limits and offsets can also be applied to pick out specific rows from an ordered result. Conceptually, these are fairly simple, however.

These tables and queries are available as part of the book download. Feel free to load the data into `sqlite3` and try out different queries. Don't worry about creating `SELECT` statements that use every available clause. Start with simple queries where you can understand all the steps, then start to combine clauses to build larger and more complex queries.

## What's Next

Now that we've had a much closer look at the `SELECT` command, you've seen most of the core SQL language. The next chapter will take a more detailed look at database design. This will help you lay out your tables and data in a way that reinforces the strengths of the database system. Understanding some of the core design ideas should also make it more clear why `SELECT` works the way it does.



# Database Design

Relational databases have only one type of data container: the table. When designing any database, the main concern is defining the tables that make up the database and defining how those tables reference and interact with each other.

Designing tables for a database is a lot like designing classes or data structures for an application. Simple designs are largely driven by common sense, but as things get larger and more complex, it takes some experience and insight to keep the design clean and on target. Understanding basic design principles and standard approaches can be a big help.

## Tables and Keys

Tables may look like simple two-dimensional grids of simple values, but a well-defined table has a fair amount of structure. Different columns can play different roles. Some columns act as unique identifiers that define the intent and purpose of each row. Other columns hold supporting data. Still other columns act as external references that link rows in one table to rows in another table. When designing a table, it is important to understand why each column is there, and what role each column is playing.

## Keys Define the Table

When designing a table, you usually start by specifying the *primary key*. The primary key consists of one or more columns that uniquely identify each row of a table. In a sense, the primary key values represent the fundamental identity of each row in the table. The primary key columns identify what the table is all about. All the other columns should provide supporting data that is directly relevant to the primary key.

Sometimes the primary key is an actual unique data value, such as a room number or a hostname. Very often the primary key is simply an arbitrary identification number, such as an employee or student ID number. The important point is that primary keys must be unique over every *possible* entry in the table, not just the rows that happen to be in there right now. This is why names are normally not used as primary keys—in a large group of people, it is too easy to end up with duplicate (or very similar) names.

While there is nothing particularly special about the columns that make up a primary key, the keys themselves play a very important role in the design and use of a database. Their role as a unique identifier for each row makes them analogous to the key of a hash table, or the key to a dictionary class of data structure. They are essentially “lookup” values for the rows of a table.

A primary key can be identified in the `CREATE TABLE` command. Explicitly identifying the primary key will cause the database system to automatically create a `UNIQUE` index across all of the primary key columns. Declaring the primary key also allows for some syntax shortcuts when establishing relationships between tables.

For example, this table definition defines the `employee_id` field to be a primary key:

```
CREATE TABLE employee (  
    employee_id INTEGER PRIMARY KEY NOT NULL,  
    name       TEXT NOT NULL  
    /* ...etc... */  
);
```

For more information on the syntax used to define a primary key, see the section “Primary keys” on page 40.

In schema documentation, primary keys are often indicated with the abbreviation “PK.” It is also common to double underline primary keys when drawing out tables, as shown in Figure 6-1.

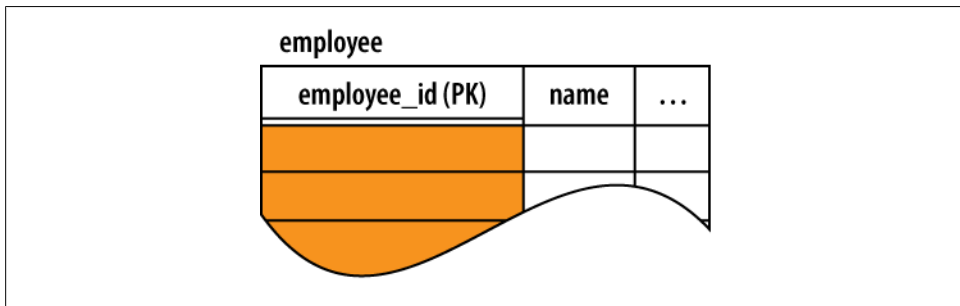

Figure 6-1. Primary keys are sometimes identified with the abbreviation PK. It is also common to use a double underline when diagramming the table.

Many database queries use a table's primary key as either the input or output. The database might be asked to return the row with a given key, such as, "return the record for employee #953." It is also common to ask for collections of keys, such as, "gather the ID values for all employees hired more than two years ago." This set of keys might then be joined to another table as part of a report.

## Foreign Keys

In addition to identifying each row in a table, primary keys are also central to joining tables together. Since the primary key acts as a unique row identifier, you can create a reference to a specific row by recording the row's primary key. This is known as a *foreign key*. A foreign key is a copy or recording of a primary key, and is used as a reference or pointer to a different (or "foreign") row, most often in a different table.

Like the primary key, columns that make up a foreign key can be identified within the `CREATE TABLE` command. In this example, we define the format of a task assignment. Each task gets assigned to a specific employee by referencing the `employee_id` field from the `employee` table:

```
CREATE TABLE task_assignment (
    task_assign_id INTEGER PRIMARY KEY,
    task_name      TEXT      NOT NULL,
    employee_id    INTEGER NOT NULL REFERENCES employee( employee_id )
    /* ...etc... */
);
```

The `REFERENCES` constraint indicates that this column is a foreign key. The constraint indicates which table is referenced and, optionally, which column. If no column is indicated, the foreign key will reference the primary key (meaning the column reference used in the prior example is not required, since `employee_id` is the primary key of the `employee` table). The vast majority of foreign keys will reference a primary key, but if a column other than the primary key is used, that column must have a `UNIQUE` constraint, or it must have a single-column `UNIQUE` index.

A foreign key can also be defined as a table constraint. In that case, there may be multiple local columns that refer to multiple columns in the referenced table. The referenced columns must be a multicolumn primary key, or they must otherwise have a multicolumn `UNIQUE` index. A foreign key definition can include several other optional parts. For the full syntax, see [CREATE TABLE](#) in [Appendix C](#).

Unlike a table's own primary key, foreign keys are not required to be unique. This is because multiple foreign key values (multiple rows) in one table may refer to the same row in another table. This is known as a one-to-many relationship. Please see the section "[One-to-Many Relationships](#)" on page 95. Foreign keys are often marked with the abbreviation "FK," as shown in [Figure 6-2](#).

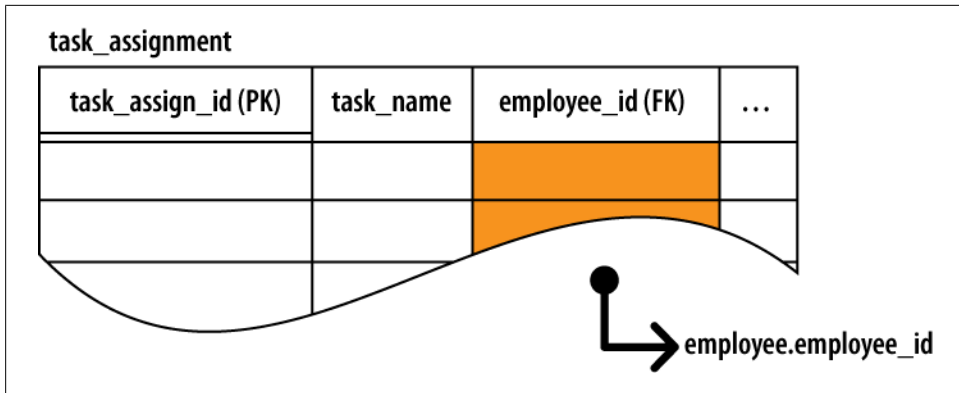

Figure 6-2. Foreign keys are copies of the primary key from another row. Foreign keys act as references or pointers to other rows. They are often identified with the abbreviation FK.

## Foreign Key Constraints

Declaring foreign keys in the table definition allows the database to enforce foreign key constraints. *Foreign key constraints* are used to keep foreign key references in sync. Among other things, foreign key constraints can prevent “dangling references” by requiring that all foreign key values correctly match a row value from the columns of the referenced table. Foreign keys can also be set to NULL. A NULL clearly marks the foreign key as unassigned, which is a bit different than having an invalid value. In many cases, unassigned foreign keys don’t fit the design of the database. In that case, the foreign key columns should be declared with a `NOT NULL` constraint.

Using our previous example, foreign key constraints would require that every `task_assignment.employee_id` element needs to contain the value of a valid `employee.employee_id`. By default, a NULL foreign key would also be allowed, but we’ve defined the `task_assignment.employee_id` column with a `NOT NULL` constraint. This demands that every task reference a valid employee.

Native foreign key support was added in SQLite 3.6.19, but is turned off by default. You must use the `PRAGMA foreign_keys` command to turn on foreign key constraints. This was done to avoid problems with existing applications and database files. A future version of SQLite may have foreign key constraints enabled by default. If your application is dependent on this setting, it should explicitly turn it on or off.

Modifications to either the foreign key table or the referenced table can potentially cause violations of the foreign key constraint. For example, if a statement attempted to update a `task_assignment.employee_id` value to an invalid `employee_id`, the foreign key constraint would be violated. Similarly, if an `employee` row was assigned a new `employee_id` value, any existing `task_assignment` references that point to the old value would become invalid. This would also violate the foreign key constraint.



If the database detects a change that would cause a foreign key violation, there are several actions that can be taken. The default action is to prohibit the change. For example, if you attempted to delete an employee that still had tasks assigned to them, the delete would fail. You would need to delete the tasks or transfer them to a different employee before you could delete the original employee.

Other conflict resolutions are also available. For example, using an `ON DELETE CASCADE` foreign key definition, deleting an employee would cause the database to automatically delete any tasks assigned to that employee. For more information on conflict resolutions and other advanced foreign key options, please see the SQLite website. Up-to-date documentation on SQLite’s support for foreign keys can be found at <http://www.sqlite.org/foreignkeys.html>.

Correctly defining foreign keys is one of the most critical aspects of data integrity and security. Once defined, foreign key constraints make sure that data relationships remain valid and consistent.

## Generic ID Keys

If you look at most database designs, you’ll notice that a large number of the tables have a generic ID column that is used as the primary key. The ID is typically an arbitrary integer value that is automatically assigned as new rows are inserted. The number may be incrementally assigned, or it might be assigned from a sequence mechanism that is guaranteed to never assign the same ID number twice.

When an SQLite column is defined as an `INTEGER PRIMARY KEY`, that column will replace the hidden `ROWID` column that acts as the root column of every table. Using an `INTEGER PRIMARY KEY` allows for some significant performance enhancements. It also allows SQLite to automatically assign sequenced ID values. For more details, see “[Primary keys](#)” on page 40.

At first, a generic ID field might seem like a design cheat. If each table should have a specific and well-defined role, then the primary key should reflect what makes any given row unique—reflecting, in part, the essential definition of the items in a table. Using a generic and arbitrary ID to define that uniqueness seems to be missing the point.

From a theoretical standpoint, that may be correct, but this is one of those areas where theory bumps into reality, and reality usually wins.

Practically speaking, many datasets don’t have a truly unique representation. For example, the names of people are not sufficiently unique to be used as database keys. Names are reasonably unique, and they do a fair job at identifying individuals in person, but they lack the inherent and complete uniqueness that good database design demands. Names also change from time to time, such as when people get married.

The more you dig around, the more you’ll find that the world is full of data like this. Data that is sufficiently unique and stable for casual use, but not truly, absolutely

unique or fixed enough to use as a smart database key. In these situations, the best solution is to simply use an arbitrary ID that the database designer has total control over, even if it is meaningless outside of the database. This type of key is known as a *surrogate key*.

There are also situations when the primary key consists of three or four (or more!) columns. This is somewhat rare, but there are situations when it does come up. If you've got a large multicolumn primary key in the middle of a complex set of relationships, it can be a big pain to create and match all those multicolumn foreign keys. To simplify such situations, it is often easier to simply create an arbitrary ID and use that as the primary key.

Using an arbitrary ID is also useful if the customary primary key is physically large. Because each foreign key is a full copy of the primary key, it is unwise to use a lengthy text value or BLOB as the primary key. Rather, it would be better to use an arbitrary identifier and simply reference to the identifier.

One final comment on key names. There is often a temptation to name a generic ID field something simple, such as `id`. After all, if you've got an `employee` table, it might seem somewhat redundant to name the primary key `employee_id`; you end up with a lot of column references that read `employee.employee_id`, when it seems that `employee.id` is clear enough.

Well, by itself, it is clear enough, but primary keys tend to show up in other tables as foreign keys. While `employee.employee_id` might be slightly redundant, the name `task_assignment.employee_id` is not. That name also gives you significant clues about the column's function (a foreign key) and what table and column it references (the `employee_id` column, which is the PK column of the `employee` table). Using the same name for primary keys and foreign keys makes the inherent meaning and linkage a lot more obvious. It also allows shortcuts, such as the `NATURAL JOIN` or `JOIN...USING( )` syntax. Both of these forms require that matching columns have the exact same name.

Using a more explicit name also avoids the problem of having multiple tables, each with a column named `id`. Such a common name can make things somewhat confusing if you join together three or four tables. While I wouldn't necessarily prefix every column name, keeping primary key names unique within a database (and using the exact same name for foreign keys) can make the intent of the database design a lot more clear.

## Keep It Specific

The biggest stumbling block for beginning database developers is that they don't create enough tables. Less experienced developers tend to view tables as large and monumental structures. There tends to be a feeling that tables are important, and that each table needs a fair number of columns containing significant amounts of data to justify its existence. If a design change calls for a new column or set of data points, there tends

to be a strong desire to lump everything together into large centralized tables rather than breaking things apart into logical groups.

The “tables must be big” mentality will quickly lead to poor designs. While you will have a few large, significant tables at the core of most designs, a typical design will also have a fair number of smaller auxiliary tables that may only hold two or three columns of data. In fact, in some cases you may find yourself building tables that consist of nothing but external references to other tables. Creating a new table is the only means you have to define a new data structure or data container, so any time you find yourself needing a new container, that’s going to indicate a new table.

Every table should have a well-defined and clear role, but that doesn’t always mean it will be big or stuffed with data.

## Common Structures and Relationships

Database design has a small number of design structures and relationships that act as basic building blocks. Once you master how to use them and how to manipulate them, you can use these building blocks to build much larger and more complex data representations.

### One-to-One Relationships

The most basic kind of inter-table relationship is the *one-to-one relationship*. As you can guess, this type of relationship establishes a reference from a single row in one table to a single row in another table. Most commonly, one-to-one relationships are represented by having a foreign key in one table reference a primary key in another table. If the foreign key column is made unique, only one reference will be allowed. As [Figure 6-3](#) illustrates, a unique foreign key creates a one-to-one relationship between the rows of the two tables.

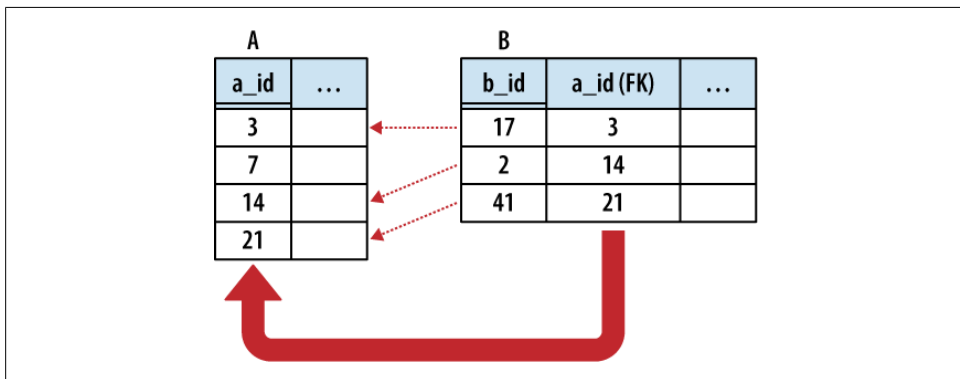

Figure 6-3. In a one-to-one relationship, table B has a foreign key that references the primary key of table A. This associates every non-NULL foreign key in table B with some row in table A.

In the strictest sense, a foreign key relationship is a one-to-(zero or one) relationship. When two tables are involved in a one-to-one relationship, there is nothing to enforce that every primary key has an incoming reference from a foreign key. For that matter, if the foreign key allows NULLs, there may be unassigned foreign keys as well.

One-to-one relationships are commonly used to create *detail tables*. As the name implies, a detail table typically holds details that are linked to the records in a more prominent table. Detail tables can be used to hold data that is only relevant to a small subsection of the database application. Breaking the detail data apart from the main tables allows different sections of the database design to evolve and grow much more independently.

Detail tables can also be helpful when extended data only applies to a limited number of records. For example, a website might have a `sales_items` table that lists common information (price, inventory, weight, etc.) for all available items. Type-specific data can then be held in detail tables, such as `cd_info` for CDs (artist name, album name, etc.) or `dvd_info` (directors, studio, etc.) for DVDs. Although the `sales_items` table would have a unique one-to-one relationship with every type-specific info table, each individual row in the `sales_item` table would be referenced by only one type of detail table.

One-to-one relationships can also be used to isolate very large data elements, such as BLOBs. Consider an employee database that contains an image of each employee. Due to the data storage and I/O overhead, it might be unwise to include a `photo` column directly in the `employee` table, but it is easy to create a photo table that references the employee table. Consider these two tables:

```
CREATE TABLE employee (  
    employee_id INTEGER NOT NULL PRIMARY KEY,  
    name        TEXT NOT NULL  
    /* ...etc... */  
);  
  
CREATE TABLE employee_photo (  
    employee_id INTEGER NOT NULL PRIMARY KEY  
                REFERENCES employee,  
    photo_data  BLOB  
    /* ...etc... */  
);
```

This example is a bit unique, because the `employee_photo.employee_id` column is both the primary key for the `employee_photo` table, as well as a foreign key to the `employee` table. Since we want a one-to-one relationship, it makes sense to just pair up primary keys. Because this foreign key does not allow NULL keys, every `employee_photo` row must be matched to a specific `employee` row. The database does not guarantee that every `employee` will have a matching `employee_photo`, however.

## One-to-Many Relationships

One-to-many relationships establish a link between a single row in one table to multiple rows in another table. This is done by expanding a one-to-one relationship, allowing one side to contain duplicate keys. One-to-many relationships are often used to associate lists or arrays of items back to a single row. For example, multiple shipping addresses can be linked to a single account. Unless otherwise specified, “many” usually means “zero or more.”

The only difference between a one-to-one relationship and a one-to-many relationship is that the one-to-many relationship allows for duplicate foreign key values. This allows multiple rows in one table (the many table) to refer back to a single row in another table (the One table). In building a one-to-many relationship, the foreign key must always be on the many side.

Figure 6-4 illustrates the relationship in more detail.

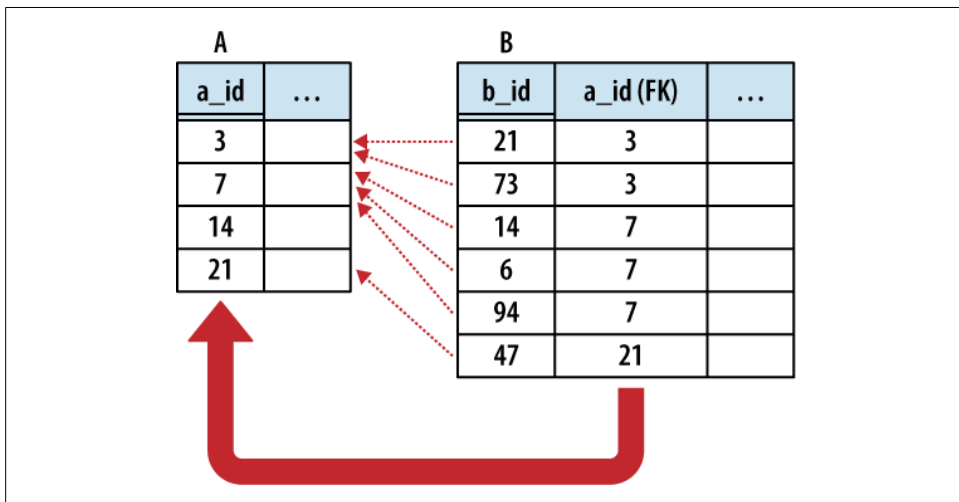

Figure 6-4. When building a one-to-many relationship, the primary keys must be unique, but foreign key columns may contain duplicate values. This means a one-to-many relationship must have the foreign key on the many side. Here we see a foreign key value in Table B refer to the primary key in Table A.

Any time you find yourself wondering how to stuff an array or list into the column of a table, the solution is to separate the array elements out into their own table and establish a one-to-many relationship.



If you need to represent a list or array, try using a one-to-many relationship.

The same is true any time you start to contemplate sets of columns, such as `item0`, `item1`, `item2`, etc., that are all designed to hold instances of the same type of value. Such designs have inherent limits, and the insert, update, and removal process becomes quite complex. It is much easier to just break the data out into its own table and establish a proper relationship.

One example of a one-to-many relationship is music albums, and the songs they contain. Each album has a list of songs associated with that album. For example:

```
CREATE TABLE albums (
    album_id INTEGER NOT NULL PRIMARY KEY,
    album_name TEXT );

CREATE TABLE tracks (
    track_id INTEGER NOT NULL PRIMARY KEY,
    track_name TEXT,
    track_number INTEGER,
    track_length INTEGER, -- in seconds
    album_id INTEGER NOT NULL REFERENCES albums );
```

Each album and track has a unique ID. Each track also has a foreign key reference back to its album. Consider:

```
INSERT INTO albums VALUES ( 1, "The Indigo Album" );
INSERT INTO tracks VALUES ( 1, "Metal Onion", 1, 137, 1 );
INSERT INTO tracks VALUES ( 2, "Smooth Snake", 2, 212, 1 );
INSERT INTO tracks VALUES ( 3, "Turn A", 3, 255, 1 );

INSERT INTO albums VALUES ( 2, "Morning Jazz" );
INSERT INTO tracks VALUES ( 4, "In the Bed", 1, 214, 2 );
INSERT INTO tracks VALUES ( 5, "Water All Around", 2, 194, 2 );
INSERT INTO tracks VALUES ( 6, "Time Soars", 3, 265, 2 );
INSERT INTO tracks VALUES ( 7, "Liquid Awareness", 4, 175, 2 );
```

To get a simple list of tracks and their associated album, we just join the tables back together. We can also sort by both album name and track number:

```
sqlite> SELECT album_name, track_name, track_number
...> FROM albums JOIN tracks USING ( album_id )
...> ORDER BY album_name, track_number;
```

album_name	track_name	track_number
Morning Jazz	In the Bed	1
Morning Jazz	Water All	2
Morning Jazz	Time Soars	3
Morning Jazz	Liquid Awa	4
The Indigo A	Metal Onio	1
The Indigo A	Smooth Sna	2
The Indigo A	Turn A	3

We can also manipulate the track groupings:

```
sqlite> SELECT album_name, sum( track_length ) AS runtime, count(*) AS tracks
...> FROM albums JOIN tracks USING ( album_id )
...> GROUP BY album_id;
```

album_name	runtime	tracks
The Indigo Album	604	3
Morning Jazz	848	4

This query groups the tracks based off their album, and then aggregates the track data together.

## Many-to-Many Relationships

The next step is the many-to-many relationship. A *many-to-many relationship* associates one row in the first table to many rows in the second table while simultaneously allowing individual rows in the second table to be linked to multiple rows in the first table. In a sense, a many-to-many relationship is really two one-to-many relationships built across each other.

Figure 6-5 shows the classic many-to-many example of people and groups. One person can belong to many different groups, while each group is made up of many different people. Common operations are to find all the groups a person belongs to, or to find all the people in a group.

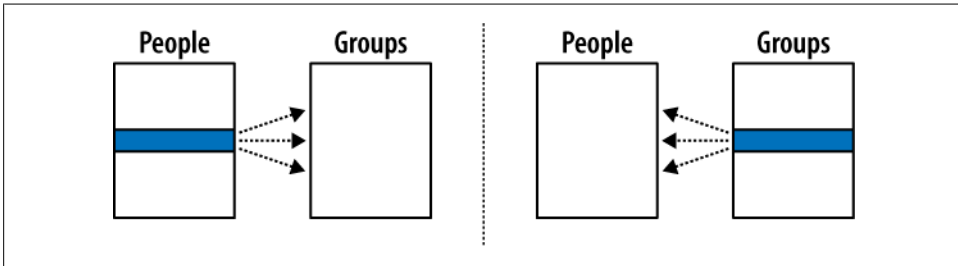

Figure 6-5. A many-to-many relationship is like two one-to-many relationships built across each other. In this example, each individual person can be a member of one or more groups, while each group can contain one or more people.

Many-to-many relationships are a bit more complex than other relationships. Although the tables have a many-to-many relationship with each other, the entries in both tables must remain unique. We cannot duplicate either person rows or group rows for the purpose of matching keys. This is a problem, since each foreign key can only reference one row. This makes it impossible for a foreign key of one table (such as a group) to refer to multiple rows of another table (such as people).

To solve this, we go back to the advice from before: if you need to add a list to a row, break out that list into its own table and establish a one-to-many relationship with the new table. You cannot directly represent a many-to-many relationship with only two tables, but you can take a pair of one-to-many relationships and link them together. The link requires a small table, known as a *link table*, or *bridge table*, that sits between the two many tables. Each many-to-many relationship requires a unique bridge table.

In its most basic form, the bridge table consists of nothing but two foreign keys—one for each of the tables it is linking together. Each row of the bridge table links one row in the first many table to one row in the second many table. In our People-to-Groups example, the link table defines a membership of one person in one group. This is illustrated in Figure 6-6.

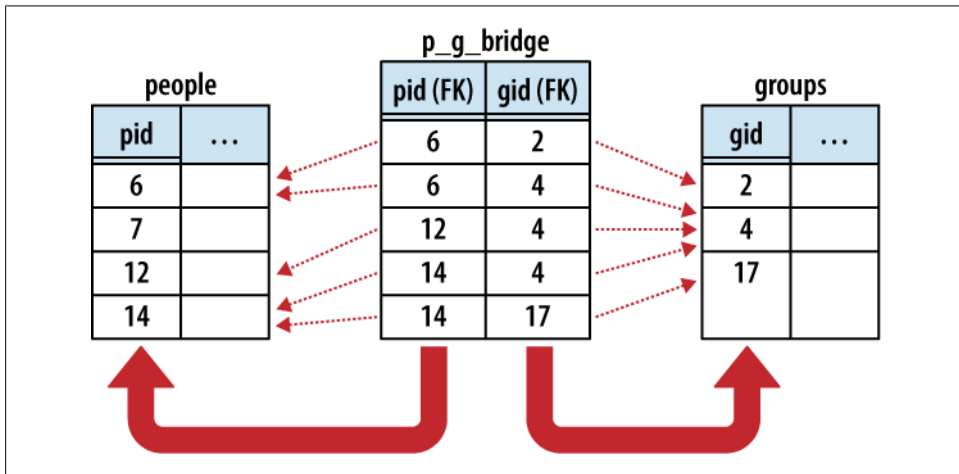

Figure 6-6. Implementing a many-to-many relationship requires a bridge table. In this example, each row of the bridge table represents a membership of one person in one group. Note that the primary key of the bridge table is a multicolumn key over (*p\_id*, *g\_id*). This keeps memberships unique.

The logical representation of a many-to-many relationship is actually a one-to-many-to-one relationship, with the bridge table (acting as a record of membership) in the middle. Each person has a one-to-many relationship with memberships, just as groups have a one-to-many relationship with memberships. In addition to binding the two tables together, the bridge table can also hold additional information about the membership itself, such as a first-joined date or an expiration date.

Here are three tables. The `people` and `groups` table are obvious enough. The `p_g_bridge` table acts as the bridge table between the `people` table and `groups` table. The two columns are both foreign key references, one to `people` and one to `groups`. Establishing a primary key across both foreign key columns ensures the memberships remain unique:

```
CREATE TABLE people ( pid INTEGER PRIMARY KEY, name TEXT, ... );
CREATE TABLE groups ( gid INTEGER PRIMARY KEY, name TEXT, ... );
CREATE TABLE p_g_bridge(
    pid INTEGER NOT NULL REFERENCES people,
    gid INTEGER NOT NULL REFERENCES groups,
    PRIMARY KEY ( pid, gid )
);
```



This query will list all the groups that a person belongs to:

```
SELECT groups.name AS group_name
FROM people JOIN p_g_bridge USING ( pid ) JOIN groups USING ( gid )
WHERE people.name = search_person_name;
```

The query simply links `people` to `groups` using the bridge table, and then filters out the appropriate rows.

We don't always need all three tables. This query counts all the members of a group without utilizing the `people` table:

```
SELECT name AS group_name, count(*) AS members
FROM groups JOIN p_g_bridge USING ( gid )
GROUP BY gid;
```

There are many other queries we can do, like finding all the groups that have no members:

```
SELECT name AS group_name
FROM groups LEFT OUTER JOIN p_g_bridge USING ( gid )
WHERE pid IS NULL;
```

This query performs an outer join from the `groups` table to the `p_g_bridge` table. Any unmatched group rows will be padded out with a `NULL` in the `p_g_bridge.pid` column. Since this column is marked `NOT NULL`, we know the only possible way for a row to be `NULL` in that column is from the outer join, meaning the row is unmatched to any memberships. A very similar query could be used to find any people that have no memberships.

## Hierarchies and Trees

Hierarchies and other tree-style data relationships are common and frequently show up in database design. Modeling one in a database can be a challenge because you tend to ask different types of questions when dealing with hierarchies.

Common tree operations include finding all the sub-nodes under a given node, or querying the depth of a given node. These operations have an inherent recursion in them—a concept that SQL doesn't support. This can lead to clumsy queries or complex representations.

There are two common methods for representing a tree relation using database tables. The first is the *adjacency model*, which uses a simple representation that is easy to modify but complex to query. The other common representation is the *nested set*, which allows relatively simple queries, but at the cost of a more complex representation that can be expensive to modify.

## Adjacency Model

A tree is basically a series of nodes that have a one-to-many relationship between the parents and the children. We already know how to define a one-to-many relationship: give each child a foreign key that points to the primary key of the parent. The only trick is that the same table is sitting on both sides of the relationship.

For example, here is a basic adjacency model table:

```
CREATE TABLE tree (  
    node INTEGER NOT NULL PRIMARY KEY,  
    name TEXT,  
    parent INTEGER REFERENCES tree );
```

Each node in the tree will have a unique node identifier. Each node will also have a reference to its parent node. The root of the tree can simply have a NULL parent reference. This allows multiple trees to be stored in the same table, as multiple nodes can be defined as a root node of different trees.

If we want to represent this tree:

```
A  
  A.1  
    A.1.a  
  A.2  
    A.2.a  
    A.2.b  
  A.3
```

We would use the following data:

```
INSERT INTO tree VALUES ( 1, 'A', NULL );  
INSERT INTO tree VALUES ( 2, 'A.1', 1 );  
INSERT INTO tree VALUES ( 3, 'A.1.a', 2 );  
INSERT INTO tree VALUES ( 4, 'A.2', 1 );  
INSERT INTO tree VALUES ( 5, 'A.2.a', 4 );  
INSERT INTO tree VALUES ( 6, 'A.2.b', 4 );  
INSERT INTO tree VALUES ( 7, 'A.3', 1 );
```

The following query will give a list of nodes and parents by joining the tree table to itself:

```
sqlite> SELECT n.name AS node, p.name AS parent  
...> FROM tree AS n JOIN tree AS p ON n.parent = p.node;
```

node	parent
A.1	A
A.1.a	A.1
A.2	A
A.2.a	A.2
A.2.b	A.2
A.3	A

Inserting or removing nodes is fairly straightforward, as is moving subtrees around to different parents.

What isn't easy are tree-centric operations, like counting all of the nodes in a subtree, or computing the depth of a specific node (often used for output formatting). You can do limited traversals (like finding a grand-parent) by joining the tree table to itself multiple times, but you cannot write a single query that can compute an answer to these types of questions on a tree of arbitrary size. The only choice is to write application routines that loop over different levels in the tree, computing the answers you seek.

Overall, the adjacency model is easy to understand, and the trees are easy to modify. The model is based on foreign keys, and can take full advantage of the database's built-in referential integrity. The major disadvantage is that many types of common data queries require the application code to loop over several individual database queries and assist in calculating answers.

### Nested set

As the name implies, the nested set representation depends on nesting groups of nodes inside other groups. Rather than representing some type of parent-child relationship, each node holds bounding data about the full subtree underneath it. With some clever math, this allows us to query all kinds of information about a node.

A nested set table might look like this:

```
CREATE TABLE nest (
  name TEXT,
  lower INTEGER NOT NULL UNIQUE,
  upper INTEGER NOT NULL UNIQUE,
  CHECK ( lower < upper ) );
```

The nested set can be visualized by converting the tree structure into a parenthetical representation. We then count the parentheses and record the upper and lower bound of each nested set. The index numbers can also be calculated with a depth-first tree traversal, where the lower bound is a pre-visit count and the upper bound is a post-visit count.

```
A( A.1( A.1.a( ) ), A.2( A.2.a( ), A.2.b( ) ), A.3( ) )
 1  2    3 4 5      6      7 8      9 10 11  12 13 14
```

Or, in SQL:

```
INSERT INTO nest VALUES ( 'A',      1, 14 );
INSERT INTO nest VALUES ( 'A.1',    2,  5 );
INSERT INTO nest VALUES ( 'A.1.a',  3,  4 );
INSERT INTO nest VALUES ( 'A.2',    6, 11 );
INSERT INTO nest VALUES ( 'A.2.a',  7,  8 );
INSERT INTO nest VALUES ( 'A.2.b',  9, 10 );
INSERT INTO nest VALUES ( 'A.3',   12, 13 );
```

This might not look that useful, but it allows a number of different queries. For example, if you want to find all the leaf nodes (nodes without children) just look for nodes that have an upper and lower value that are next to each other:

```
SELECT name FROM nest WHERE lower + 1 = upper;
```

You can find the depth of a node by counting all of its ancestors:

```
sqlite> SELECT n.name AS name, count(*) AS depth
...> FROM nest AS n JOIN nest AS p
...> ON p.lower <= n.lower AND p.upper >= n.upper
...> GROUP BY n.name;
```

name	depth
A	1
A.1	2
A.1.a	3
A.2	2
A.2.a	3
A.2.b	3
A.3	2

There are many other queries that match patterns or differences in the upper and lower bounds.

Nested sets are very efficient at calculating many types of queries, but they are expensive to change. For the math to work correctly, there can't be any gaps in the numbering sequence. This means that any insert or delete requires renumbering a significant number of entries in the table. This isn't bad for something with a few dozen nodes, but it can quickly prove impractical for a tree with hundreds of nodes.

Additionally, because nested sets aren't based off any kind of key reference, the database can't help enforce the correctness of the tree structure. This leaves database integrity and correctness in the hands of the application—something that is normally avoided.

### More information

This is just a brief overview of how to represent tree relationships. If you need to implement a tree, I suggest you do a few web searches on *adjacency model* or *nested set*. Many of the larger SQL books mentioned in “[Wrap-up](#)” on page 58 also have sections on tree and hierarchies.

## Normal Form

You won't get too far into most database design books without reading a discussion on normalization and the Normal Forms. The *Normal Forms* are a series of forms, or table design specifications, that describe the best way to lay out data in a database. The higher the normal form, the more normalized the database is. Each form builds on the previous one, adding additional rules or conditions that must be met. *Normalization* is the process of removing data duplication, more clearly defining key relationships, and generally moving towards a more idealized database form. It is possible for different tables in the same database to be at different levels.

Most people recognize five normal forms simply referred to as the First Normal Form through the Fifth Normal Form. These are often abbreviated 1NF through 5NF. There are also a few named forms, such as the Boyce-Codd Normal Form (BCNF). Most of these other forms are roughly equivalent to one of the numbered forms. For example, BCNF is a slight extension to the Third Normal Form. Some folks also recognize higher levels of normalization, such as a Sixth Normal Form and beyond, but these extreme levels of normalization are well beyond the practical concerns of most database designers.

## Normalization

The normalization process is useful for two reasons. First, normalization specifies design criteria that can act as a guide in the design process. If you have a set of tables that are proving to be difficult to work with, that often points to a deeper design problem or assumption. The normalization process provides a set of rules and conditions that can help identify trouble spots, as well as provide possible solutions to reorganize the data in a more consistent and clean fashion.

The other advantage, which shows up more at runtime, is that data integrity is much easier to enforce and maintain in a normalized database. Although the overall database design is often more complex (i.e., more tables), the individual parts are usually much simpler and fill more clearly defined roles. This often translates to better `INSERT`, `UPDATE`, and `DELETE` performance, since changes are often smaller and more localized.

Localizing data is a core goal of data normalization. Most of the normal forms deal with eliminating redundant or replicated data so that each unique token of data is stored once—and only once—in the database. Everything else simply references that definitive copy. This makes updates easier, since there is only one place an update needs to be applied, but it also makes the data more consistent, as it is impossible for multiple copies of the data to become out of sync with each other. When working on a schema design, a question you should constantly ask yourself is, “If this piece of data changes, how many different places will I need to make that change?” If the answer is anything other than one, chances are you’re not in Normal Form.

## Denormalization

Normalizing a database and spreading the data out into different tables means that queries usually involve joining several tables back together. This can occasionally lead to performance concerns, especially for complex reports that require data from a large number of tables. These concerns can sometimes lead to the process of *denormalization*, where duplicate copies of the same data are intentionally introduced to reduce the number of joins required for common queries. This is typically done on systems that are primarily read-only, such as data-warehouse databases, and is often done by computing temporary tables from properly normalized source data.

While a large number of joins can lead to performance concerns, database optimization is just like code optimization—don't start too early and don't make assumptions. In general, the advantages of normalization far outweigh the costs. A correct database that runs a tad slower is infinitely more useful than a very fast database that returns incorrect or inconsistent answers.

## The First Normal Form

The *First Normal Form*, or *1NF*, is the lowest level of normalization. It is primarily concerned with making sure a table is in the proper format. There are three conditions that must be met for a table to be in 1NF.

The first condition relates to ordering. To be in 1NF, the individual rows of a table cannot have any meaningful or inherent order. Each row should be an isolated, stand-alone record. The meaning of a value in one row cannot depend on any of the data values from neighboring rows, either by insertion order, or by some sorted order. This condition is usually easy to meet, as SQL does not guarantee any kind of row ordering.

The second condition is uniqueness. Every row within a 1NF table must be unique, and must be unique by those columns that hold meaningful data for the application. For example, if the only difference between two rows is the database-maintained `ROWID` column, then the rows aren't really unique. However, it is perfectly fine to consider an arbitrary sequence ID (such as an `INTEGER PRIMARY KEY`) to be part of the application data. This condition establishes that the table must have some type of `PRIMARY KEY`, consisting of one or more columns that creates a unique definition of what the table represents.

The third and final condition for 1NF requires that every column of every row holds one (and only one) logical value that cannot be broken down any further. The concern is not with compound types, such as dates (which might be broken down into integer day, month, and year values) but with arrays or lists of logical values. For example, you shouldn't be recording a text value that contains a comma-separated list of logical, independent values. Arrays or lists should be broken out into their own one-to-many relationships.

## The Second Normal Form

The *Second Normal Form*, or *2NF*, deals with compound keys (multicolumn keys) and how other columns relate to such keys. 2NF has only one condition: every column that is not part of the primary key must be relevant to the primary key as a whole, and not just a sub-part of the key.

Consider a table that lists all the conference rooms at a large corporate campus. At minimum, the `conf_room` table has columns for `building_num` and `room_num`. Taken together, these two columns will uniquely identify any conference room across the whole campus, so that will be our compound primary key.

Next, consider a column like `seating_capacity`. The values in this column are directly dependent on each specific conference room. That, by definition, makes the column dependent on both the building number and the room number. Including the `seating_capacity` column will not break 2NF.

Now consider a column like `building_address`. This column is dependent on the `building_num` column, but it is not dependent on the `room_num` column. Since `building_address` is dependent on only part of the primary key, including this column in the `conf_room` table would break 2NF.

Because 2NF is specifically concerned with multicolumn keys, any table with a single-column primary key that is in 1NF is automatically in 2NF.

To recognize a column that might be breaking 2NF, look for columns that have duplicate values. If the duplicate values tend to line up with duplicate values in one of the primary key columns, that is a strong indication of a problem. For example, the `building_address` column will have a number of duplicate values (assuming most buildings have more than one conference room). The duplicate address values can be matched to duplicate values in the `building_num` column. This alignment shows how the address column is tied to only the `building_num` column specifically, and not the whole primary key.

## The Third Normal Form

The *Third Normal Form*, or 3NF, extends the 2NF to eliminate transitive key dependencies. A transitive dependency is when A depends on B, and B depends on C, and therefore A depends on C. 3NF requires that each nonprimary key column has a direct (nontransitive) dependency on the primary key.

For example, consider an inventory database that is used to track laptops at a small business. The `laptop` table will have a primary key that uniquely identifies each laptop, such as an inventory control number. It is likely the table would have other columns that include the make and model of the machine, the serial number, and perhaps a purchase date. For our example, the `laptop` table will also include a `responsible_person_id` column. When an employee is assigned a laptop, their employee ID number is put in this column.

Within a row, the value of the `responsible_person_id` column is directly dependent on the primary key. In other words, each individual laptop is assigned a specific responsible person, making the values in the `responsible_person_id` column directly dependent on the primary key of the `laptop` table.

Now consider what happens when we add a column like `responsible_person_email`. This is a column that holds the email address of the responsible person. The value of this column is still dependent on the primary key of the `laptop` table. Each individual laptop has a specific `responsible_person_email` field that is just as unique as the `responsible_person_id` field.

The problem is that the values in the `responsible_person_email` column are not *directly* dependent on an individual laptop. Rather, the email column is tied to the `responsible_person_id`, and the `responsible_person_id` is, in turn, dependent on the individual laptop. This transitive dependency breaks 3NF, indicating that the `responsible_person_email` column doesn't belong there.

In the `employee` table, we will also find both a `person_id` column and an `email` column. This is perfectly acceptable if the `person_id` is the primary key (likely). That would make the `email` column directly dependent on the primary key, keeping the table in 3NF.

A good way to recognize columns that may break 3NF is to look for pairs or sets of unrelated columns that need to be kept in sync with each other. Consider the `laptop` table. If a system was reassigned to a new person, you would always update both the `responsible_person_id` column and the `responsible_person_email` column. The need to keep columns in sync with each other is a strong indication of a dependency to each other, rather than to the primary key.

## Higher Normal Forms

We're not going to get into the details of BCNF, or the Fourth or Fifth (or beyond) Normal Forms, other than to mention that the Fourth and Fifth Normal Forms start to deal with inter-table relationships and how different tables interact with each other. Most database designers make a solid effort to get everything into 3NF and then stop worrying about it. It turns out that if you get the hang of things and tend to turn out table designs that are in 3NF, chances are pretty good that your tables will also meet the conditions for 4NF and 5NF, if not higher. To a large extent, the higher Normal Forms are formal ways of addressing some edge cases that are somewhat unusual, especially in simpler designs.

Although the conditions of the Normal Forms build on each other, the typical design process doesn't actually iterate over the individual Forms. You don't sit down with a new design and alter it until everything is 1NF, just to turn around and muck with the design until everything is 2NF, and so on, in a isolated step-by-step manner. Once you understand the ideas and concepts behind the First, Second, and Third Normal Forms, it becomes second nature to design directly to 3NF. Stepping over the conditions one at a time can help you weed out especially difficult trouble spots, but it doesn't take long to gain a sense of when a design looks clean and when something "just ain't right."

The core concept to remember is that each table should try to represent one and only one thing. The primary key(s) for that table should uniquely and inherently identify the concept behind the table. All other columns should provide supporting data specific to that one concept. When speaking of the first three Normal Forms in a 1982 CACM article, William Kent wrote that each non-key column ". . . must provide a fact about the key, the whole key, and nothing but the key." If you incorporate only one formal aspect of database theory into your designs, that would be a great place to start.



# Indexes

Indexes (or indices) are auxiliary data structures used by the database system to enforce unique constraints, speed up sort operations, and provide faster access to specific records. They are often created in hopes of making queries run faster by avoiding table scans and providing a more direct lookup method.

Understanding where and when to create indexes can be an important factor in achieving good performance, especially as datasets grow. Without proper indexes in place, the database system has no option but to do full table scans for every lookup. Table scans can be especially expensive when joining tables together.

Indexes are not without cost, however. Each index must maintain a one-to-one correspondence between index entries and table rows. If a new row is inserted, updated, or deleted from a table, that same modification must be made to all associated indexes. Each new index will add additional overhead to the `INSERT`, `UPDATE`, and `DELETE` commands. Indexes also consume space, both on disk as well as in the SQLite page cache. A proper, well-placed index is worth the cost, but it isn't wise to just create random indexes, in hopes that one of them will prove useful. A poorly placed index still has all the costs, and can actually slow queries down. You can have too much of a good thing.

## How They Work

Each index is associated with a specific table. Indexes can be either single column or multicolumn, but all the columns of a given index must belong to the same table. There is no limit to the number of indexes a table can have, nor is there a limit on the number of indexes a column can belong to. You cannot create an index on a view or on a virtual table.

Internally, the rows of a normal table are stored in an indexed structure. SQLite uses a B-Tree for this purpose, which is a specific type of multi-child, balanced tree. The details are unimportant, other than understanding that as rows are inserted into the tree, the rows are sorted, organized, and optimized, so that a row with a specific, known ROWID can be retrieved relatively directly and quickly.

When you create an index, the database system creates another tree structure to hold the index data. Rather than using the ROWID column as the sort key, the tree is sorted and organized using the column or columns you've specified in the index definition. The index entry consists of a copy of the values from each of the indexed columns, as well as a copy of the corresponding ROWID value. This allows an indexed entry to be found very quickly using the values from the indexed columns.

If we have a table like this:

```
CREATE TABLE tbl ( a, b, c, d );
```

And then create an index that looks like this:

```
CREATE INDEX idx_tbl_a_b ON tbl ( a, b );
```

The database generates an internal data structure that is conceptually similar to:

```
SELECT a, b, ROWID FROM tbl ORDER BY a, b;
```

If SQLite needs to quickly find all the rows where, for example, `a = 45`, it can use the sorted index to quickly jump to that range of values and extract the relevant index entries. If it's looking for the value of `b`, it can simply extract that from the index and be done. If we need any other value in the row, it needs to fetch the full row. This is done by looking up the `ROWID`. The last value of any index entry is the `ROWID` of its corresponding table row. Once SQLite has a list of `ROWID` values for all rows where `a = 45`, it can efficiently look up those rows in the original table and retrieve the full row. If everything works correctly, the process of looking up a small set of index entries, and then using those to look up a small set of table rows, will be much faster and more efficient than doing a full table scan.

## Must Be Diverse

To have a positive impact on query performance, indexes must be diverse. The cost of fetching a single row through an index is significantly higher than fetching a single row through a table scan. To reduce the overall cost, an index must overcome this overhead by eliminating the vast majority of row fetches. By significantly reducing the number of row lookups, the total query cost can be reduced, even if the individual row lookups are more expensive.

The break-even point for index performance is somewhere in the 10% to 20% range. Any query that fetches more rows from a table will do better with a table scan, while any query that fetches fewer rows will see an improvement by using an index. If an index cannot isolate rows to this level, there is no reason for it to be there. In fact, if the query optimizer mistakenly uses an index that returns a large percentage of rows, the index can reduce performance and slow things down.

This creates two concerns. First, if you're trying to improve the performance of a query that fetches a moderate percentage of rows, adding an index is unlikely to help. An index can only improve performance if it is used to target a focused number of rows.

Second, even if the query is asking for a specific value, this can still lead to a higher percentage of fetched rows if the indexed columns are not reasonably unique. For example, if a column only has four unique values, a successful query will never fetch fewer than approximately 25% of the rows (assuming a reasonable distribution of values or queries). Adding an index to this type of column will not improve performance. Creating an index on a true/false column would be even worse.

When the query optimizer is trying to figure out if it should use an index or not, it typically has very little information to go on. For the most part, it assumes that if an

index exists, it must be a good index, and it will tend to use it. The `ANALYZE` command can help mitigate this by providing statistical information to the query optimizer (see [ANALYZE](#) for more details), but keeping that updated and well maintained can be difficult in many environments.

To avoid problems, you should avoid creating indexes on columns that are not reasonably unique. Indexing such columns rarely provides any benefit, and it can confuse the query optimizer.

## INTEGER PRIMARY KEYS

When you declare one or more columns to be a `PRIMARY KEY`, the database system automatically creates a unique index over those columns. The fundamental purpose of this index is to enforce the `UNIQUE` constraint that is implied with every `PRIMARY KEY`. It also happens that many database operations typically involve the primary key, such as natural joins, or conditional lookups in `UPDATE` or `DELETE` commands. Even if the index wasn't required to enforce the `UNIQUE` constraint, chances are good you would want an index over those columns anyway.

There are further advantages to using an `INTEGER PRIMARY KEY`. As we've discussed, when an `INTEGER PRIMARY KEY` is declared, that column replaces the automatic `ROWID` column, and becomes the root column for the tree. In essence, the column becomes the index used to store the table itself, eliminating the need for a second, external index.

`INTEGER PRIMARY KEY` columns also provide better performance than standard indexes. `INTEGER PRIMARY KEYS` have direct access to the full set of row data. A normal index simply references the `ROWID` value, which is then looked up in the table root. `INTEGER PRIMARY KEYS` can provide indexed lookups, but skip this second lookup step, and directly access the table data.

If you're using generic row ID values, it is worth the effort to define them as `INTEGER PRIMARY KEY` columns. Not only will this reduce the size of the database, it can make your queries faster and more efficient.

## Order Matters

When creating a multicolumn index for performance purposes, the column order is very important. If an index has only one column, that column is used as the sort key. If additional columns are specified in the index definition, the additional columns will be used as secondary, tertiary, etc., sort keys. All of the data is sorted by the first column, then any groups of duplicate values are further sorted by the second column, and so on. This is very similar to a typical phonebook. Most phone books sort by last name. Any group of common last names is then sorted by first name, and then by middle name or initial.

In order to utilize a multicolumn index, a query must contain conditions that are able to utilize the sort keys in the same order they appear in the index definition. If the query does not contain a condition that keys off the first column, the index cannot be used.

Consider looking up a name in the phonebook. You can use a phonebook to quickly find the phone number for “Jennifer T. Smith.” First, you look up the last name “Smith.” Then you refine the search, looking for the first name, “Jennifer,” and finally the middle initial “T” (if required). This sequence should allow you to focus in on a specific entry very quickly.

A phonebook isn’t much use to quickly find all the people with the first name “Jennifer.” Even though the first name is part of the phonebook index, it isn’t the first column of the index. If our query cannot provide a specific condition for the first column of a multicolumn index, the index cannot be used, and our only option is to do a full scan. At that point it is usually more efficient to do a full scan on the table itself, rather than the index.

It is not necessary to utilize every column, only that you utilize the columns in order. If you’re looking up a very unique name in the phone book, you may not need to search off the first name or middle initial. Or, perhaps your query is to find every “Smith.” In that case, the conditions of the query are satisfied with just the first column.

In the end, you need to be very careful when considering the order of a multicolumn index. The additional columns should be viewed as a refinement on the first column, not a replacement. A single multicolumn index is very different from multiple single-column indexes. If you have different queries that use different columns as the main lookup condition, you may be better off with multiple small indexes, rather than one large multicolumn index.

## One at a Time

Multicolumn indexes are very useful in some situations, but there are limitations on when they can be effectively used. In some cases, it is more appropriate to create multiple single-column indexes on the same table.

This too has limitations. You cannot create a single-column index on every column of a table and expect the query system to mix and match whatever indexes it needs. Once a subset of rows is extracted from a table (via index or full table scan), that set of rows conceptually becomes an independent temporary table that is no longer part of the original table. At that point, any index associated with the source table becomes unavailable.

In general, the query optimizer can only utilize one index per table-instance per query. Multiple indexes on a single table only make sense if you have a different queries that extract rows using different columns (or have multiple **UNIQUE** constraints). Different queries that key off different columns can pick the index that is most appropriate, but

each individual query will only use one index per table-instance. If you want a single query to utilize multiple indexed columns, you need a multicolumn index.

The major exception is a series of **OR** conditions. If a **WHERE** clause has a chain of **OR** conditions on one or more columns of the same table, then there are cases when SQLite may go ahead and use multiple indexes for the same table in a single query.

## Index Summary

For all their power, indexes are often a source of great frustration. The right index will result in a huge performance boost, while the wrong index can significantly slow things down. All indexes add cost to table modifications and add bulk to the database size. A well-placed index is often worth the overhead costs, but it can be difficult to understand what makes a well-placed index.

To complicate matters, you don't get to tell the query optimizer when or how to use your indexes—the query planner makes its own decisions. Having everything be automatic means that queries will work no matter what, but it can also make it difficult to determine if an index is being used. It can be even more difficult to figure out why an index is being ignored.

This essentially leaves the database designer in the position of second-guessing the query optimizer. Changes and optimizations must be searched for on something of a trial-and-error basis. To make things worse, as your application changes and evolves, changes in the query structure or patterns can cause a change in index use. All in all, it can be a difficult situation to manage.

Traditionally, this is where the role of the *DBA*, or *Database Administrator*, comes in. This person is responsible for the care and feeding of a large database server. They do things like monitor query efficiency, adjust tuning parameters and indexes, and make sure all the statistical data is kept up to date. Unfortunately, that whole idea is somewhat contrary to what SQLite is all about.

So how do you maintain performance? For starters, have a solid design. A well-crafted and normalized database is going to go a long way toward defining your access patterns. Taking the time to correctly identify and define your primary keys will allow the database system to create appropriate indexes and give the query optimizer (and future developers) some insight into your design and intentions.

Also remember that (with the exception of **UNIQUE** constraints) a database will operate correctly without any indexes. It might be slow, but all the answers will be correct. This lets you worry about design first, and performance later. Once you have a working design, it is always possible to add indexes after the fact, without needing to alter your table structure or your query commands.

The queries of a fully normalized database will typically have quite a few **JOIN** operations. Nearly all of these joins are across primary and foreign keys. Primary keys are

automatically indexed, but in most cases you need to manually create indexes on your foreign keys. With those in place, your database should already have the most critical indexes defined.

Start from here. Measure the performance of the different types of queries your application uses and find the problem areas. Looking at these queries, try to find columns where an index might boost performance. Look for any constraints and conditions that may benefit from an index, especially in join conditions that reference nonkey columns. Use `EXPLAIN` and `EXPLAIN QUERY PLAN` to understand how SQLite is accessing the data. These commands can also be used to verify if a query is using an index or not. For more information, see `EXPLAIN` in [Appendix C](#). You can also use the `sqlite3_stmt_status()` function to get a more measured understanding of statement efficiency. See `sqlite3_stmt_status()` in [Appendix G](#) for more details.

All in all, you shouldn't get too hung up on precise index placement. You may need a few well-placed indexes to deal with larger tables, but the stock `PRIMARY KEY` indexes do surprisingly well in most cases. Further index placement should be considered performance tuning and shouldn't be worried about until an actual need is identified. Never forget that indexes have cost, so you shouldn't create them unless you can identify a need.

## Transferring Design Experience

If you have some experience designing application data structures or class hierarchies, you may have noticed some similarities between designing runtime structures and database tables. Many of the organization principles are the same and, thankfully, much of the design knowledge and experience gained in the application development world will transfer to the database world.

There are differences, however. Although these differences are minor, they often prove to be significant stumbling blocks for experienced developers that are new to database design. With a little insight, we can hopefully avoid the more common misconceptions, opening up the world of database design to those with existing experience in data structure and class design.

## Tables Are Types

The most common misconception is to think of tables as *instances* of a compound data structure. A table looks a whole lot like an array or a dynamic list, so it is easy to make this mistake.

Tables should be thought of as type definitions. You should never use a named table as a data organizer or record grouping. Rather, each table definition should be treated like a data structure definition or a class definition. SQL DDL commands such as `CREATE TABLE` are conceptually similar to those C/C++ header files that define an application's

data structures and classes. The table itself should be considered a global management pool for all instances of that type. If you need a new instance of that type, you simply insert a new row. If you need to group or catalog sets of instances, do that with key associations, not by creating new tables.

If you ever find yourself creating a series of tables with identical definitions, that's usually a big warning. Any time your application uses string manipulation to programmatically build table names, that's also a big warning—especially if the table names are derived from values stored elsewhere in the database.

## Keys Are Backwards Pointers

Another stumbling block is the proper use of keys. Keys are very similar to pointers. A primary key is used to identify a unique instance of a data structure. This is similar to the address of a record. Anything that wants to reference that record needs to record its address as a pointer or, in the cases of databases, as a foreign key. Foreign keys are essentially database pointers.

The trick is that database references are backwards. Rather than pointers that indicate ownership (“I manage that”), foreign keys indicate a type of possession (“I am managed by that”).

In C or C++, if a main data record manages a list of sub-records, the main data record would have some kind of pointer list. Each pointer would reference a specific sub-record associated with this main record. If you are dealing with the main data record and need the list of sub-records, you simply look at the pointer list.

Databases do it the other way around. In a one-to-many relationship, the main record (the “one” side row) would simply have a primary key. All the sub-records (the “many” side rows) would have foreign keys that point back at the main record. If you are dealing with the main record and need the list of sub-records, you ask the database system to look at the global pool of all subrecord instances and return just those subrecords that are managed by this main record.

This tends to make application developers uncomfortable. This is not the way traditional programming language data structures tend to be organized, and the idea of searching a large global record pool just to retrieve a small number of records tends to raise all kinds of performance concerns. Thankfully, this is exactly the kind of thing that databases are very good at doing.

## Do One Thing

My final design advice is more general. As with data structures or classes, the fundamental idea behind a table is that it should represent instances of one single idea or “thing.” It might represent a set of nouns or things, such as people, or it might represent verbs or actions, such as a transaction log. Tables can even represent less concrete

things, such as a many-to-many bridge table that records membership. But no matter what it is, each table should have one, and *only* one, clearly defined role in the database. Normally the problem isn't too many tables, it is too few.

If the meaning of one field is ever dependent on the value of another field, the design is heading in a bad direction. Two different meanings should have two different tables (or two different columns).

## Closing

As with application development, database design is part science and part art. It may seem quite complex, with keys to set up, different relationships to define, Normal Forms to follow, and indexes to create.

Thankfully, the basics usually fall into place fairly quickly. If you start to get into larger or more complex designs, some reading on more formal methods of data modeling and database design might be in order, but most developers can get pretty far by just leveraging their knowledge and experience in designing application data structures. In the end, you're just defining data structures and hooking them together.

Finally, don't expect to get it right the first time. Very often, when going through the database design process, you realize that your understanding of the thing you're trying to store is incorrect or incomplete. Just as you might refactor a class hierarchy, don't be afraid to refactor a database design. It should be an evolving thing, just like your application code and data structures.



---

# C Programming Interface

The `sqlite3` command-line utility is designed to provide an interactive interface for end users. It is extremely useful to design and test out SQL queries, debug database files, and experiment with new features of SQLite, but it was never meant to interface with other applications. While the command-line utility can be used for very basic scripting and automated tasks, if you want to write an application that utilizes the SQLite library in any serious manner, it is expected that you'll use a programming interface.

The native SQLite programming interface is in C, and that is the interface this chapter will cover. If you're working in something else, there are wrappers and extensions available for many other languages, including most popular scripting languages. With the exception of the Tcl interface, all of these wrappers are provided by third parties and are not part of the SQLite product. For more information on language wrappers, see [“Scripting Languages and Other Interfaces” on page 172](#).

Using the C API allows your application to interface directly with the SQLite library and the database engine. You can link a static or dynamic build of the SQLite library into your application, or simply include the amalgamation source file in your application's build process. The best choice depends on your specific situation. See [“Build and Installation Options” on page 23](#) for more details.

The C API is fairly extensive, and provides full access to all of SQLite's features. In fact, the `sqlite3` command-line utility is written using the public C API. This chapter covers the core features of the API, while the following chapters cover more advanced features.

## API Overview

Even when using the programming interface, the primary way of interacting with your data is to issue SQL commands to the database engine. This chapter focuses on the core of the API that is used to convey SQL command strings to the database engine. It is important to understand that there are no public functions to walk the internal structure of a table or, for example, access the tree structure of an index. You must use SQL to query data from the database. In order to be successful with the SQLite API,

you not only need to understand the C API, but you also need to know enough SQL to form meaningful and efficient queries.

## Structure

The C API for SQLite 3 includes a dozen-plus data structures, a fair number of constants, and well over one hundred different function calls. While the API is somewhat large, using it doesn't have to be complex. A fair number of the functions are highly specialized and infrequently used by most developers. Many of the remaining functions are simple variations of the same basic operation. For example, there are a dozen variations on the `sqlite3_value_xxx()` function, such as `sqlite3_value_int()`, `sqlite3_value_double()`, and `sqlite3_value_text()`. All of these functions perform the same basic operation and can be considered simple type variations of the same basic interface.



When referring to a whole category of functions, either in text or in pseudo code, I'll simply refer to them as the `sqlite3_value_xxx()` functions. Much of the SQLite documentation refers to them as `sqlite3_value_*`, but I prefer to use the `xxx` notation to avoid any confusion with pointers. There are no actual SQLite3 functions with the letter sequence `xxx` in the name.

All public API function calls and datatypes have the prefix `sqlite3_`, indicating they are part of version 3.x of the SQLite product. Most of the constants, such as error codes, use the prefix `SQLITE_`. The design and API differences between SQLite 2.x and 3.x were significant enough to warrant a complete change of all API names and structures. The depth of these changes required anyone upgrading from SQLite 2 to SQLite 3 to modify their application, so changing the names of the API functions only helped keep the names distinct and keep any version questions clear. The distinct names also allowed applications that were in transition to link to both libraries at the same time.

In addition to the `sqlite3_` prefix, public function calls can be identified by the use of lowercase letters and underscores in their names. Private functions use run-together capitalized words (also known as CamelCase). For example, `sqlite3_create_function()` is a public API function (used to register a user-defined SQL function), while `sqlite3CreateFunc()` is an internal function that should never be called directly. Internal functions are not in the public header file, are not documented, and are subject to change at any time.

The stability of the public interface is extremely important to the SQLite development team. An existing API function call will not be altered once it has been made public. The only possible exceptions are brand new interfaces that are marked *experimental*, and even experimental interfaces tend to become fairly solid after a few releases.

If a revised version of a function call is needed, the newer function will generally be introduced with the suffix `_v2`. For example, when a more flexible version of the existing `sqlite3_open()` function was introduced, the old version of the function was retained as is and the new, improved `sqlite3_open_v2()` was introduced. Although no `_v3` (or higher) functions currently exist, it is possible they may be introduced in the future.

By adding a new function, rather than modifying the parameters of an existing function, new code could take advantage of the newer features, while existing, unmodified code could continue to link against updated versions of the SQLite library. The use of a different function name also means that if a newer application is ever accidentally linked against an older version of the library, the result will be a link error rather than a program crash, making it much easier to track down and resolve the problem.

## Strings and Unicode

There are a number of API functions that have a `16` variant. For instance, both an `sqlite3_column_text()` function and an `sqlite3_column_text16()` function are available. The first requests a text value in UTF-8 format, while the second will request a text value in UTF-16.

All of the strings in an SQLite database file are stored using the same encoding. SQLite database files support the UTF-8, UTF-16LE, and UTF-16BE encodings. A database's encoding is determined when the database is created.

Regardless of the database, you can insert or request text values in either UTF-8 or UTF-16. SQLite will automatically convert text values between the database encoding and the API encoding. The UTF-16 encoding passed by the `16` APIs will always be in the machine's native byte order. UTF-16 buffers use a `void*` C data type. The `wchar_t` data type is not used, as its size is not fixed, and not all platforms define a 16-bit type.

Most of the string- and text-related functions have some type of length parameter. SQLite does not assume input text values are null-terminated, so explicit lengths are often required. These lengths are always given in bytes, not characters, regardless of the string encoding.

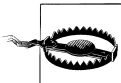

All string lengths are given in *bytes*, not *characters*, even if the string uses a multi-byte encoding such as UTF-16.

This difference is important to keep in mind when using international strings.

## Error Codes

SQLite follows the convention of returning integer error codes in any situation when there is a chance of failure. If data needs to be passed back to the function caller, it is returned through a reference parameter.

In all cases, if a function succeeds, it will return the constant `SQLITE_OK`, which happens to have the value zero. If something went wrong, API functions will return one of the standard error codes to indicate the nature of the error.

More recently, a set of extended error codes were introduced. These provide a more specific indication of what went wrong. However, to keep things backwards compatible, these extended codes are only available when you activate them.

The situation is complex enough to warrant its own discussion later in the chapter. It will be much easier to explain the different error codes once you've had a chance to see how the API works. See [“Result Codes and Error Codes” on page 146](#) for more details.

I also have to give the standard “do as I say, not as I do” caveat about properly checking error codes and return results. The example code in this chapter and elsewhere in this book tends to have extremely terse (as in, almost none at all) error checking. This is done to keep the examples short and clear. Needless to say, this isn't the best approach for production code. When working with your own code, do the right thing and check your error codes.

## Structures and Allocations

Although the native SQLite API is often referred to as a C/C++ API, technically the interface is only available in C. As mentioned in [“Building” on page 21](#), the SQLite source code is strictly C based, and as such can only be compiled with a C compiler. Once compiled, the library can be easily linked to, and called from, both C and C++ code, as well as any other language that follows the C linking conventions for your platform.

Although the API is written in C, it has a distinct object-like flavor. Most of the program state is held in a series of opaque data structures that act like objects. The most common data structures are database connections and prepared statements. You should never directly access the fields of these data structures. Instead, functions are provided to create, destroy, and manipulate these structures in much the same way that object methods are used to manipulate object instances. This results in an API design that has similar feelings to an object-oriented design. In fact, if you download one of the third-party C++ wrappers, you'll notice that the wrappers tend to be rather thin, owing most of their structure to the underlying C functions and the data structures.

It is important that you allow SQLite to allocate and manage its own data structures. The design of the API means that you should never manually allocate one of these structures, nor should you put these structures on the stack. The API provides calls to

internally allocate the proper data structures, initialize them, and return them. Similarly, for every function that allocates a data structure, there is some function that is used to clean it up and release it. As with memory management, you need to be sure these calls are balanced, and that every data structure that is created is eventually released.

## More Info

The core of the SQLite API focuses on opening database connections, preparing SQL statements, binding parameter values, executing statements, and finally stepping through the results. These procedures are the focus of this chapter.

There are also interfaces to create your own SQL functions, load dynamic modules, and create code-driven virtual tables. We'll be covering some of these more advanced interfaces in other chapters.

Beyond that, there are a fair number of management and customization functions. Not all of these are covered in the main part of the book, but a reference for the full API can be found in [Appendix G](#). If the description of a function leaves you with additional questions, be sure to check that appendix for more specific details.

## Library Initialization

Before an application can use the SQLite library to do anything, the library must first be initialized. This process allocates some standard resources and sets up any OS-specific data structures. By default, most major API function calls will automatically initialize the library, if it has not already been initialized. It is considered a good practice to manually initialize the library, however.

```
int sqlite3_initialize( )
```

Initializes the SQLite library. This function should be called prior to any other function in the SQLite API. Calling this function after the library has already been initialized is harmless. This function can be called after a shutdown to reinitialize the library. A return value of `SQLITE_OK` indicates success.

When an application is finished using the SQLite library, the library should be shut down.

```
int sqlite3_shutdown( )
```

Releases any resources allocated by `sqlite3_initialize()`. Calling this function before the library has been initialized or after the library has already been shut down is harmless. A return value of `SQLITE_OK` indicates success.

Because of the automatic initialization features, many applications never call either of these functions. Rather, they call `sqlite3_open()`, or one of the other primary functions, and depend on the library to automatically initialize itself. In most cases this is safe enough, but for maximum compatibility it is best to call these functions explicitly.

# Database Connections

Before we can prepare or execute SQL statements, we must first establish a database connection. Most often this is done by opening or creating an SQLite3 database file. When you are done with the database connection, it must be closed. This verifies that there are no outstanding statements or allocated resources before closing the database file.

## Opening

Database connections are allocated and established with one of the `sqlite3_open_xxx()` commands. These pass back a database connection in the form of an `sqlite3` data structure. There are three variants:

```
int sqlite3_open( const char *filename, sqlite3 **db_ptr )
int sqlite3_open16( const void *filename, sqlite3 **db_ptr )
```

Opens a database file and allocates an `sqlite3` data structure. The first parameter is the filename of the database file you wish to open, given as a null-terminated string. The second parameter is a reference to an `sqlite3` pointer, and is used to pass back the new connection. If possible, the database will be opened read/write. If not, it will be opened read-only. If the given database file does not exist, it will be created.

The first variant assumes that the database filename is encoded in UTF-8, while the second assumes that the database filename is encoded in UTF-16.

```
int sqlite3_open_v2( const char *filename, sqlite3 **db_ptr,
                    int flags, const char *vfs_name )
```

The `_v2` variant offers more control over how the database file is created and opened. The first two parameters are the same. The filename is assumed to be in UTF-8. There is no UTF-16 variant of this function.

A third parameter is a set of bit-field flags. These flags allow you to specify if SQLite should attempt to open the database read/write (`SQLITE_OPEN_READWRITE`), or read-only (`SQLITE_OPEN_READONLY`). If you ask for read/write access but only read-only access is available, the database will be opened in read-only mode.

This variant of `open` will not create a new file for an unknown filename unless you explicitly allow it using the `SQLITE_OPEN_CREATE` flag. This only works if the database is being opened in read/write mode.

There are also a number of other flags dealing with thread and cache management. See `sqlite3_open()` in [Appendix G](#) for more details. The standard version of `open` is equivalent to the flag values of (`SQLITE_OPEN_READWRITE | SQLITE_OPEN_CREATE`).

The final parameter allows you to name a VFS (Virtual File System) module to use with this database connection. The VFS system acts as an abstraction layer between the SQLite library and any underlying storage system (such as a filesystem). In nearly all cases, you will want to use the default VFS module and can simply pass in a NULL pointer.

For new code, it is recommended that you use the call `sqlite3_open_v2()`. The newer call allows more control over how the database is opened and processed.

The use of the double pointer may be a bit confusing at first, but the idea behind it is simple enough. The pointer-to-a-pointer is really nothing more than a pointer that is passed by reference. This allows the function call to modify the pointer that is passed in. For example:

```
sqlite3 *db = NULL;
rc = sqlite3_open_v2( "database.sqlite3", &db, SQLITE_OPEN_READWRITE, NULL );
/* hopefully, db now points to a valid sqlite3 structure */
```

Note that `db` is an `sqlite3` pointer (`sqlite3*`), not an actual `sqlite3` structure. When we call `sqlite3_open_xxx()` and pass in the pointer reference, the open function will allocate a new `sqlite3` data structure, initialize it, and set our pointer to point to it.

This approach, including the use of a pointer reference, is a common theme in the SQLite APIs that are used to create or initialize something. They all basically work the same way and, once you get the hang of them, they are pretty straightforward and easy to use.

There is no standard file extension for an SQLite3 database file, although `.sqlite3`, `.db`, and `.db3` are popular choices. The extension `.sdb` should be avoided, as this extension has special meaning on some Microsoft Windows platforms, and may suffer from significantly slower I/O performance.

The string encoding used by a database file is determined by the function that is used to create the file. Using `sqlite3_open()` or `sqlite3_open_v2()` will result in a database with the default UTF-8 encoding. If `sqlite3_open16()` is used to create a database, the default string encoding will be UTF-16 in the native byte order of the machine. You can override the default string encoding with the SQL command `PRAGMA encoding`. See [encoding](#) in [Appendix F](#) for more details.

## Special Cases

In addition to recognizing standard filenames, SQLite recognizes a few specialized filename strings. If the given filename is a NULL pointer or an empty string (`""`), then an anonymous, temporary, on-disk database is created. An anonymous database can only be accessed through the database connection that created it. Each call will create a new, unique database instance. Like all temporary items, this database will be destroyed when the connection is closed.

If the filename `:memory:` is used, then a temporary, in-memory database is created. In-memory databases live in the database cache and have no backing store. This style of database is extremely fast, but requires sufficient memory to hold the entire database image in memory. As with anonymous databases, each open call will create a new, unique, in-memory database, making it impossible for more than one database connection to access a given in-memory database.

In-memory databases make great structured caches. It is not possible to directly image an in-memory database to disk, but you can copy the contents of an in-memory database to disk (or disk to memory) using the database backup API. See the section [sqlite3\\_backup\\_init\(\)](#) in [Appendix G](#) for more details.

## Closing

To close and release a database connection, call `sqlite3_close()`.

```
int sqlite3_close( sqlite3 *db )
```

Closes a database connection and releases any associated data structures. All temporary items associated with this connection will be deleted. In order to succeed, all prepared statements associated with this database connection must be finalized. See “[Reset and Finalize](#)” on [page 130](#) for more details.

Any pointer returned by a call to `sqlite3_open_xxx()`, including a NULL pointer, can be passed to `sqlite3_close()`. This function verifies there are no outstanding changes to the database, then closes the file and frees the `sqlite3` data structure. If the database still has nonfinalized statements, the `SQLITE_BUSY` error will be returned. In that case, you need to correct the problem and call `sqlite3_close()` again.

In most cases, `sqlite3_open_xxx()` will return a pointer to an `sqlite3` structure, even when the return code indicates a problem. This allows the caller to retrieve an error message with `sqlite3_errmsg()`. (See “[Result Codes and Error Codes](#)” on [page 146](#).) In these situations, you must still call `sqlite3_close()` to free the `sqlite3` structure.

## Example

Here is the outline of a program that opens a database, performs some operations, and then closes it. Most of the other examples in this chapter will build from this example by inserting code into the middle:

```
#include "sqlite3.h"
#include <stdlib.h>

int main( int argc, char **argv )
{
    char          *file = ""; /* default to temp db */
    sqlite3       *db = NULL;
    int           rc = 0;
```



```

if ( argc > 1 )
    file = argv[1];

sqlite3_initialize( );
rc = sqlite3_open_v2( file, &db, SQLITE_OPEN_READWRITE |
                    SQLITE_OPEN_CREATE, NULL );

if ( rc != SQLITE_OK ) {
    sqlite3_close( db );
    exit( -1 );
}

/* perform database operations */

sqlite3_close( db );
sqlite3_shutdown( );
}

```

The default filename is an empty string. If passed to `sqlite3_open_xxx()`, this will result in a temporary, on-disk database that will be deleted as soon as the database connection is closed. If at least one argument is given, the first argument will be used as a filename. If the database does not exist, it will be created and then opened for read/write access. It is then immediately closed.

If this example is run using a new filename, it will not create a valid database file. The SQLite library delays writing the database header until some actual data operation is performed. This “lazy” initialization gives an application the chance to adjust any relevant pragmas, such as the text encoding, page size, and database file format, before the database file is fully created.

## Prepared Statements

Once a database connection is established, we can start to execute SQL commands. This is normally done by preparing and stepping through statements. Statements are held in `sqlite3_stmt` data structures.

### Statement Life Cycle

The life cycle of a prepared statement is a bit complex. Unlike database connections, which are typically opened, used for some period of time, and then closed, a statement can be in a number of different states. A statement might be prepared, but not run, or it might be in the middle of processing. Once a statement has run to completion, it can be reset and re-executed multiple times before eventually being finalized and released.

The life cycle of a typical `sqlite3_stmt` looks something like this (in pseudo-code):

```
/* create a statement from an SQL string */
sqlite3_stmt *stmt = NULL;
sqlite3_prepare_v2( db, sql_str, sql_str_len, &stmt, NULL );

/* use the statement as many times as required */
while( ... )
{
    /* bind any parameter values */
    sqlite3_bind_xxx( stmt, param_idx, param_value... );
    ...

    /* execute statement and step over each row of the result set */
    while ( sqlite3_step( stmt ) == SQLITE_ROW )
    {
        /* extract column values from the current result row */
        col_val = sqlite3_column_xxx( stmt, col_index );
        ...
    }

    /* reset the statement so it may be used again */
    sqlite3_reset( stmt );
    sqlite3_clear_bindings( stmt ); /* optional */
}

/* destroy and release the statement */
sqlite3_finalize( stmt );
stmt = NULL;
```

The prepare process converts an SQL command string into a prepared statement. That statement can then have values bound to any statement parameters. The statement is then executed, or “stepped through.” In the case of a query, each step will make a new results row available for processing. The column values of the current row can then be extracted and processed. The statement is stepped through, row by row, until no more rows are available.

The statement can then be reset, allowing it to be re-executed with a new set of bindings. Preparing a statement can be somewhat costly, so it is a common practice to reuse statements as much as possible. Finally, when the statement is no longer in use, the `sqlite3_stmt` data structure can be finalized. This releases any internal resources and frees the `sqlite3_stmt` data structure, effectively deleting the statement.

## Prepare

To convert an SQL command string into a prepared statement, use one of the `sqlite3_prepare_xxx()` functions:

```
int sqlite3_prepare(  sqlite3 *db, const char *sql_str, int sql_str_len,
                    sqlite3_stmt **stmt, const char **tail )
int sqlite3_prepare16( sqlite3 *db, const void *sql_str, int sql_str_len,
                     sqlite3_stmt **stmt, const void **tail )
```

It is strongly recommended that all new developments use the `_v2` version of these functions.

```
int sqlite3_prepare_v2(  sqlite3 *db, const char *sql_str, int sql_str_len,
                      sqlite3_stmt **stmt, const char **tail )
int sqlite3_prepare16_v2( sqlite3 *db, const void *sql_str, int sql_str_len,
                        sqlite3_stmt **stmt, const void **tail )
```

Converts an SQL command string into a prepared statement. The first parameter is a database connection. The second parameter is an SQL command encoded in a UTF-8 or UTF-16 string. The third parameter indicates the length of the command string in bytes. The fourth parameter is a reference to a statement pointer. This is used to pass back a pointer to the new `sqlite3_stmt` structure.

The fifth parameter is a reference to a string (char pointer). If the command string contains multiple SQL statements and this parameter is non-NULL, the pointer will be set to the start of the next statement in the command string.

These `_v2` calls take the exact same parameters as the original versions, but the internal representation of the `sqlite3_stmt` structure that is created is somewhat different. This enables some extended and automatic error handling. These differences are discussed later in [“Result Codes and Error Codes” on page 146](#).

If the length parameter is negative, the length will be automatically computed by the prepare call. This requires that the command string be properly null-terminated. If the length is positive, it represents the maximum number of bytes that will be parsed. For optimal performance, provide a null-terminated string and pass a valid length value that includes the null-termination character. If the SQL command string passed to `sqlite3_prepare_xxx()` consists of only a single SQL statement, there is no need to terminate it with a semicolon.

Once a statement has been prepared, but before it is executed, you can bind parameter values to the statement. Statement parameters allow you to insert a special token into the SQL command string that represents an unspecified literal value. You can then bind specific values to the parameter tokens before the statement is executed. After execution, the statement can be reset and new parameter values can be assigned. This allows you to prepare a statement once and then re-execute it multiple times with different parameter values. This is commonly used with commands, such as `INSERT`, that have a common structure but are repeatedly executed with different values.

Parameter binding is a somewhat in-depth topic, so we’ll get back to that in the next section. See [“Bound Parameters” on page 133](#) for more details.

## Step

Preparing an SQL statement causes the command string to be parsed and converted into a set of byte-code commands. This byte-code is fed into SQLite's *Virtual Database Engine* (VDBE) for execution. The translation is not a consistent one-to-one affair. Depending on the database structure (such as indexes), the query optimizer may generate very different VDBE command sequences for similar SQL commands. The size and flexibility of the SQLite library can be largely attributed to the VDBE architecture.

To execute the VDBE code, the function `sqlite3_step()` is called. This function steps through the current VDBE command sequence until some type of program break is encountered. This can happen when a new row becomes available, or when the VDBE program reaches its end, indicating that no more data is available.

In the case of a `SELECT` query, `sqlite3_step()` will return once for each row in the result set. Each subsequent call to `sqlite3_step()` will continue execution of the statement until the next row is available or the statement reaches its end.

The function definition is quite simple:

```
int sqlite3_step( sqlite3_stmt *stmt )
```

Attempts to execute the provided prepared statement. If a result set row becomes available, the function will return with a value of `SQLITE_ROW`. In that case, individual column values can be extracted with the `sqlite3_column_xxx()` functions. Additional rows can be returned by making further calls to `sqlite3_step()`. If the statement execution reaches its end, the code `SQLITE_DONE` will be returned. Once this happens, `sqlite3_step()` cannot be called again with this prepared statement until the statement is first reset using `sqlite3_reset()`.

If the first call to `sqlite3_step()` returns `SQLITE_DONE`, it means that the statement was successfully run, but there was no result data to make available. This is the typical case for most commands, other than `SELECT`. If `sqlite3_step()` is called repeatedly, a `SELECT` command will return `SQLITE_ROW` for each row of the result set before finally returning `SQLITE_DONE`. If a `SELECT` command returns no rows, it will return `SQLITE_DONE` on the first call to `sqlite3_step()`.

There are also some `PRAGMA` commands that will return a value. Even if the return value is a simple scalar value, that value will be returned as a one-row, one-column result set. This means that the first call to `sqlite3_step()` will return `SQLITE_ROW`, indicating result data is available. Additionally, if `PRAGMA count_changes` is set to true, the `INSERT`, `UPDATE`, and `DELETE` commands will return the number of rows they modified as a one-row, one-column integer value.

Any time `sqlite3_step()` returns `SQLITE_ROW`, new row data is available for processing. Row values can be inspected and extracted from the statement using the `sqlite3_column_xxx()` functions, which we will look at next. To resume execution of the statement, simply call `sqlite3_step()` again. It is common to call `sqlite3_step()` in a loop, processing each row until `SQLITE_DONE` is returned.

Rows are returned as soon as they are computed. In many cases, this spreads the processing costs out across all of the calls to `sqlite3_step()`, and allows the first row to be returned reasonably quickly. However, if the query has a `GROUP BY` or `ORDER BY` clause, the statement may be forced to first gather all of the rows within the result set before it is able to complete the final processing. In these cases, it may take a considerable time for the first row to become available, but subsequent rows should be returned very quickly.

## Result Columns

Any time `sqlite3_step()` returns the code `SQLITE_ROW`, a new result set row is available within the statement. You can use the `sqlite3_column_xxx()` functions to inspect and extract the column values from this row. Many of these functions require a column index parameter (`cidx`). Like C arrays, the first column in a result set always has an index of zero, starting from the left.

```
int sqlite3_column_count( sqlite3_stmt *stmt )
```

Returns the number of columns in the statement result. If the statement does not return values, a count of zero will be returned. Valid column indexes are zero through the count minus one. (N columns have the indexes 0 through N-1).

```
const char* sqlite3_column_name(  sqlite3_stmt *stmt, int cidx )
```

```
const void* sqlite3_column_name16( sqlite3_stmt *stmt, int cidx )
```

Returns the name of the specified column as a UTF-8 or UTF-16 encoded string. The returned string is the name provided by the `AS` clause within the `SELECT` header. For example, this function would return `person_id` for column zero of the SQL statement `SELECT pid AS person_id,...`. If no `AS` expression was given, the name is technically undefined and may change from one version of SQLite to another. This is especially true of columns that consist of an expression.

The returned pointers will remain valid until one of these functions is called again on the same column index, or until the statement is destroyed with `sqlite3_finalize()`. The pointers will remain valid (and unmodified) across calls to `sqlite3_step()` and `sqlite3_reset()`, as column names do not change from one execution to the next. These pointers should not be passed to `sqlite3_free()`.

```
int sqlite3_column_type( sqlite3_stmt *stmt, int cidx )
```

Returns the native type (storage class) of the value found in the specified column. Valid return codes can be `SQLITE_INTEGER`, `SQLITE_FLOAT`, `SQLITE_TEXT`, `SQLITE_BLOB`, or `SQLITE_NULL`. To get the correct native datatype, this function should be called before any attempt is made to extract the data.

This function returns the type of the actual value found in the current row. Because SQLite allows different types to be stored in the same column, the type returned for a specific column index may vary from row to row. This is also how you detect the presence of a `NULL`.

These `sqlite3_column_xxx()` functions allow your code to get an idea of what the available row looks like. Once you've figured out the correct value type, you can extract the value with one of these typed `sqlite3_column_xxx()` functions. All of these functions take the same parameters: a statement pointer and a column index.

`const void* sqlite3_column_blob( sqlite_stmt *stmt, int cidx )`

Returns a pointer to the BLOB value from the given column. The pointer may be invalid if the BLOB has a length of zero bytes. The pointer may also be NULL if a type conversion was required.

`double sqlite3_column_double( sqlite_stmt *stmt, int cidx )`

Returns a 64-bit floating-point value from the given column.

`int sqlite3_column_int( sqlite_stmt *stmt, int cidx )`

Returns a 32-bit signed integer from the given column. The value will be truncated (without warning) if the column contains an integer value that cannot be represented in 32 bits.

`sqlite3_int64 sqlite3_column_int64( sqlite_stmt *stmt, int cidx )`

Returns a 64-bit signed integer from the given column.

`const unsigned char* sqlite3_column_text( sqlite_stmt *stmt, int cidx )`

`const void* sqlite3_column_text16( sqlite_stmt *stmt, int cidx )`

Returns a pointer to a UTF-8 or UTF-16 encoded string from the given column. The string will always be null-terminated, even if it is an empty string. Note that the returned `char` pointer is unsigned and will likely require a cast. The pointer may also be NULL if a type conversion was required.

`sqlite3_value* sqlite3_column_value( sqlite_stmt *stmt, int cidx )`

Returns a pointer to an unprotected `sqlite3_value` structure. Unprotected `sqlite3_value` structures cannot safely undergo type conversion, so you should not attempt to extract a primitive value from this structure using the `sqlite3_value_xxx()` functions. If you want a primitive value, you should use one of the other `sqlite3_column_xxx()` functions. The only safe use for the returned pointer is to call `sqlite3_bind_value()` or `sqlite3_result_value()`. The first is used to bind the value to another prepared statement, while the second is used to return a value in a user-defined SQL function (see [“Binding Values” on page 135](#), or [“Returning Results and Errors” on page 186](#)).

There is no `sqlite3_column_null()` function. There is no need for one. If the native datatype is NULL, there is no additional value or state information to extract.

Any pointers returned by these functions become invalid if another call to any `sqlite3_column_xxx()` function is made using the same column index, or when `sqlite3_step()` is next called. Pointers will also become invalid if the statement is reset or finalized. SQLite will take care of all the memory management associated with these pointers.

If you request a datatype that is different from the native value, SQLite will attempt to convert the value. Table 7-1 describes the conversion rules used by SQLite.

Table 7-1. SQLite type conversion rules.

Original type	Requested type	Converted value
NULL	Integer	0
NULL	Float	0.0
NULL	Text	NULL pointer
NULL	BLOB	NULL pointer
Integer	Float	Converted float
Integer	Text	ASCII number
Integer	BLOB	Same as text
Float	Integer	Rounds towards zero
Float	Text	ASCII number
Float	BLOB	Same as text
Text	Integer	Internal atoi()
Text	Float	Internal atof()
Text	BLOB	No change
BLOB	Integer	Converts to text, atoi()
BLOB	Float	Converts to text, atof()
BLOB	Text	Adds terminator

Some conversions are done in place, which can cause subsequent calls to `sqlite3_column_type()` to return undefined results. That's why it is important to call `sqlite3_column_type()` before trying to extract a value, unless you already know exactly what datatype you want.

Although numeric values are returned directly, text and BLOB values are returned in a buffer. To determine how large that buffer is, you need to ask for the byte count. That can be done with one of these two functions.

```
int sqlite3_column_bytes( sqlite3_stmt *stmt, int cidx )
```

Returns the number of *bytes* in a BLOB or in a UTF-8 encoded text value. If returning the size of a text value, the size will include the terminator.

```
int sqlite3_column_bytes16( sqlite3_stmt *stmt, int cidx )
```

Returns the number of *bytes* in a UTF-16 encoded text value, including the terminator.

Be aware that these functions can cause a data conversion in text values. That conversion can invalidate any previously returned pointer. For example, if you call `sqlite3_column_text()` to get a pointer to a UTF-8 encoded string, and then call `sqlite3_column_bytes16()` on the same column, the internal column value will be converted from a UTF-8 encoded string to a UTF-16 encoded string. This will invalidate the character pointer that was originally returned by `sqlite3_column_text()`.

Similarly, if you first call `sqlite3_column_bytes16()` to get the size of UTF-16 encoded string, and then call `sqlite3_column_text()`, the internal value will be converted to a UTF-8 string before a string pointer is returned. That will invalidate the length value that was originally returned.

The easiest way to avoid problems is to extract the datatype you want and then call the matching bytes function to find out how large the buffer is. Here are examples of safe call sequences:

```
/* correctly extract a blob */
buf_ptr = sqlite3_column_blob( stmt, n );
buf_len = sqlite3_column_bytes( stmt, n );

/* correctly extract a UTF-8 encoded string */
buf_ptr = sqlite3_column_text( stmt, n );
buf_len = sqlite3_column_bytes( stmt, n );

/* correctly extract a UTF-16 encoded string */
buf_ptr = sqlite3_column_text16( stmt, n );
buf_len = sqlite3_column_bytes16( stmt, n );
```

By matching the correct bytes function for your desired datatype, you can avoid any type conversions keeping both the pointer and length valid and correct.

You should always use `sqlite3_column_bytes()` to determine the size of a BLOB.

## Reset and Finalize

When a call to `sqlite3_step()` returns `SQLITE_DONE`, the statement has successfully finished execution. At that point, there is nothing further you can do with the statement. If you want to use the statement again, it must first be reset.

```
int sqlite3_reset( sqlite3_stmt *stmt )
```

Resets a prepared statement so that it is ready for another execution. A statement should be reset as soon as you're done using it. This will ensure any locks are released.

The function `sqlite3_reset()` can be called any time after `sqlite3_step()` is called. It is valid to call `sqlite3_reset()` before a statement is finished executing (that is, before `sqlite3_step()` returns `SQLITE_DONE` or an error indicator). You can't cancel a running `sqlite3_step()` call this way, but you can short-circuit the return of additional `SQLITE_ROW` values.



For example, if you only want the first six rows of a result set, it is perfectly valid to call `sqlite3_step()` only six times and then reset the statement, even if `sqlite3_step()` would continue to return `SQLITE_ROW`.

The function `sqlite3_reset()` simply resets a statement, it does not release it. To destroy a prepared statement and release its memory, the statement must be finalized.

```
int sqlite3_finalize( sqlite3_stmt *stmt )
```

Destroys a prepared statement and releases any associated resources.

The function `sqlite3_finalize()` can be called at any time on any statement that was successfully prepared. All of the prepared statements associated with a database connection must be finalized before the database connection can be closed.

Although both of these functions can return errors, they always perform their function. Any error that is returned was generated by the last call to `sqlite3_step()`. See [“Result Codes and Error Codes” on page 146](#) for more details.

It is a good idea to reset or finalize a statement as soon as you are done using it. A call to `sqlite3_reset()` or `sqlite3_finalize()` ensures the statement will release any locks it might be holding, and frees any resources associated with the prior statement execution. If an application keeps statements around for an extended period of time, they should be kept in a reset state, ready to be bound and executed.

## Statement Transitions

Prepared statements have a significant amount of state. In addition to the currently bound parameter values and other details, every prepared statement is always in one of three major states. The first is the “ready” state. Any freshly prepared or reset statement will be “ready.” This indicates that the statement is ready to execute, but hasn’t been started. The second state is “running,” indicating that a statement has started to execute, but hasn’t yet finished. The final state is “done,” which indicates the statement has completed executing.

Knowing the current state of a statement is important. Although some API functions can be called at any time (like `sqlite3_reset()`), other API functions can only be called when a statement is in a specific state. For example, the `sqlite3_bind_xxx()` functions can only be called when a statement is in its “ready” state. [Figure 7-1](#) shows the different states and how a statement transitions from one state to another.

There is no way to query the current state of a statement. Transitions between states are normally controlled by the design and flow of the application.

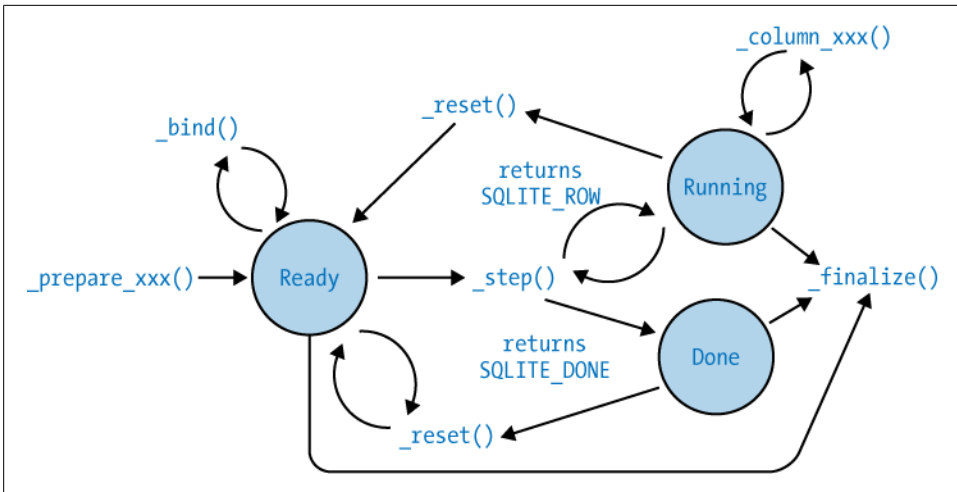

Figure 7-1. Prepared statement transitions. A statement can be in one of three states. Depending on the current state, only some API functions are valid. Calling a function in an inappropriate state will result in an `SQLITE_MISUSE` error.

## Examples

Here are two examples of using prepared statements. The first example executes a `CREATE TABLE` statement by first preparing the SQL string and then calling `sqlite3_step()` to execute the statement:

```

sqlite3_stmt *stmt = NULL;

/* ... open database ... */

rc = sqlite3_prepare_v2( db, "CREATE TABLE tbl ( str TEXT )", -1, &stmt, NULL );
if ( rc != SQLITE_OK ) exit( -1 );

rc = sqlite3_step( stmt );
if ( rc != SQLITE_DONE ) exit ( -1 );

sqlite3_finalize( stmt );

/* ... close database ... */

```

The `CREATE TABLE` statement is a DDL command that does not return any type of value and only needs to be “stepped” once to fully execute the command. Remember to reset or finalize statements as soon as they’re finished executing. Also remember that all statements associated with a database connection must be fully finalized before the connection can be closed.

This second example is a bit more complex. This code performs a `SELECT` and loops over `sqlite3_step()` extracting all of the rows in the table. Each value is displayed as it is extracted:

```
const char      *data = NULL;
sqlite3_stmt    *stmt = NULL;

/* ... open database ... */

rc = sqlite3_prepare_v2( db, "SELECT str FROM tbl ORDER BY 1", -1, &stmt, NULL );
if ( rc != SQLITE_OK) exit( -1 );

while( sqlite3_step( stmt ) == SQLITE_ROW ) {
    data = (const char*)sqlite3_column_text( stmt, 0 );
    printf( "%s\n", data ? data : "[NULL]" );
}

sqlite3_finalize( stmt );

/* ... close database ... */
```

This example does not check the type of the column value. Since the value will be displayed as a string, the code depends on SQLite's internal conversion process and always requests a text value. The only tricky bit is that the string pointer may be `NULL`, so we need to be prepared to deal with that in the `printf()` statement.

## Bound Parameters

Statement parameters are special tokens that are inserted into the SQL command string before it is passed to one of the `sqlite3_prepare_xxx()` functions. They act as a placeholder for any literal value, such as a bare number or a single quote string. After the statement is prepared, but before it is executed, you can bind specific values to each statement parameter. Once you're done executing a statement, you can reset the statement, bind new values to the parameters, and execute the statement again—only this time with the new values.

## Parameter Tokens

SQLite supports five different styles of statement parameters. These short string tokens are placed directly into the SQL command string, which can then be passed to one of the `sqlite3_prepare_xxx()` functions. Once the statement is prepared, the individual parameters are referenced by index.

?

An anonymous parameter with automatic index. As the statement is processed, each anonymous parameter is assigned a unique, sequential index value, starting with one.

?<*index*>

Parameter with explicit numeric index. Duplicate indexes allow the same value to be bound multiple places in the same statement.

:<*name*>

A named parameter with an automatic index. Duplicate names allow the same value to be bound multiple places in the same statement.

@<*name*>

A named parameter with an automatic index. Duplicate names allow the same value to be bound multiple places in the same statement. Works exactly like the colon parameter.

\$<*name*>

A named parameter with an automatic index. Duplicate names allow the same value to be bound multiple places in the same statement. This is an extended syntax to support Tcl variables. Unless you're doing Tcl programming, I suggest you use the colon format.

To get an idea of how these work, consider this `INSERT` statement:

```
INSERT INTO people (id, name) VALUES ( ?, ? );
```

The two statement parameters represent the `id` and `name` values being inserted. Parameter indexes start at one, so the first parameter that represents the `id` value has an index of one, and the parameter used to reference the `name` value has an index of two.

Notice that the second parameter, which is likely a text value, does not have single quotes around it. The single quotes are part of the string-literal representation, and are not required for a parameter value.

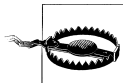

Statement parameters should not be put in quotes. The notation '?' designates a one-character text value, not a parameter.

Once this statement has been prepared, it can be used to insert multiple rows. For each row, simply bind the appropriate values, step through the statement, and then reset the statement. After the statement has been reset, new values can be bound to the parameters and the statement can be stepped again.

You can also use explicit index values:

```
INSERT INTO people (id, name) VALUES ( ?1, ?2 );
```

Using explicit parameter indexes has two major advantages. First, you can have multiple instances of the same index value, allowing the same value to be bound to more than one place in the same statement.

Second, explicit indexes allow the parameters to appear out of order. There can even be gaps in the index sequence. This can help simplify application code maintenance if the query is modified and parameters are added or removed.

This level of abstraction can be taken even further by using named parameters. In this case, you allow SQLite to assign parameter index values as it sees fit, in a similar fashion to anonymous parameters. The difference is that you can ask SQLite to tell you the index value of a specific parameter based off the name you've given it. Consider this statement:

```
INSERT INTO people (id, name) VALUES ( :id, :name );
```

In this case, the parameter values are quite explicit. As we will see in the next section, the code that binds values to these parameters is also quite explicit, making it very clear what is going on. Best of all, it doesn't matter if new parameters are added. As long as the existing names remain unchanged, the code will properly find and bind the named parameters.

Note, however, that parameters can only be used to replace literal values, such as quoted strings or numeric values. Parameters cannot be used in place of identifiers, such as table names or column names. The following bit of SQL is invalid:

```
SELECT * FROM ?; -- INCORRECT: Cannot use a parameter as an identifier
```

If you attempt to prepare this statement, it will fail. This is because the parameter (which acts as an unknown literal value) is being used where an identifier is required. This is invalid, and the statement will not prepare correctly.

Within a statement, it is best to choose a specific parameter style and stick with it. Mixing anonymous parameters with explicit indexes or named parameters is likely to cause confusion about what index belongs to which parameter.

Personally, I prefer to use the colon-name-style parameters. Using named parameters eliminates the need to know any specific index values, allowing you to just reference the name at runtime. The use of short, significant names can also make the intent of both your SQL statements and your bind code easier to understand.

## Binding Values

When you first prepare a statement with parameters, all of the parameters start out with a NULL assigned to them. Before you execute the statement, you can bind specific values to each parameter using the `sqlite3_bind_xxx()` family of functions.

There are nine `sqlite3_bind_xxx()` functions available, plus a number of utility functions. These functions can be called any time after the statement is prepared, but before `sqlite3_step()` is called for the first time. Once `sqlite3_step()` has been called, these functions cannot be called again until the statement is reset.

All the `sqlite3_bind_xxx()` functions have the same first and second parameters and return the same result. The first parameter is always a pointer to an `sqlite3_stmt`, and the second is the index of the parameter to bind. Remember that for anonymous parameters, the first index value starts with one. For the most part, the third parameter is the value to bind. The fourth parameter, if present, indicates the length of the data value in bytes. The fifth parameter, if present, is a function pointer to a memory management callback.

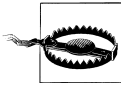

Remember that bind index values start with one (1), unlike result column indexes, which start with zero (0).

All the bind functions return an integer error code, which is equal to `SQLITE_OK` upon success.

The bind functions are:

```
int sqlite3_bind_blob( sqlite3_stmt *stmt, int pidx,
                      const void *data, int data_len, mem_callback )
```

Binds an arbitrary length binary data BLOB.

```
int sqlite3_bind_double( sqlite3_stmt *stmt, int pidx, double data )
```

Binds a 64-bit floating point value.

```
int sqlite3_bind_int(  sqlite3_stmt *stmt, int pidx, int data )
```

Binds a 32-bit signed integer value.

```
int sqlite3_bind_int64( sqlite3_stmt *stmt, int pidx, sqlite3_int64 )
```

Binds a 64-bit signed integer value.

```
int sqlite3_bind_null( sqlite3_stmt *stmt, int pidx )
```

Binds a NULL datatype.

```
int sqlite3_bind_text(  sqlite3_stmt *stmt, int pidx,
                      const char *data, int data_len, mem_callback )
```

Binds an arbitrary length UTF-8 encoded text value. The length is in bytes, not characters. If the length parameter is negative, SQLite will compute the length of the string up to, but not including, the null terminator. It is recommended that the manually computed lengths do not include the terminator (the terminator will be included when the value is returned).

```
int sqlite3_bind_text16( sqlite3_stmt *stmt, int pidx,
                        const void *data, int data_len, mem_callback )
```

Binds an arbitrary length UTF-16 encoded text value. The length is in bytes, not characters. If the length parameter is negative, SQLite will compute the length of the string up to, but not including, the null terminator. It is recommended that the manually computed lengths do not include the terminator (the terminator will be included when the value is returned).

```
int sqlite3_bind_zeroblob( sqlite3_stmt *stmt, int pidx, int len )
```

Binds an arbitrary length binary data BLOB, where each byte is set to zero (0x00). The only additional parameter is a length value, in bytes. This function is particularly useful for creating large BLOBs that can then be updated with the incremental BLOB interface. See [sqlite3\\_blob\\_open\(\)](#) in [Appendix G](#) for more details.

In addition to these type-specific bind functions, there is also a specialized function:

```
int sqlite3_bind_value( sqlite3_stmt *stmt, int pidx,  
                      const sqlite3_value *data_value )
```

Binds the type and value of an `sqlite3_value` structure. An `sqlite3_value` structure can hold any data format.

The text and BLOB variants of `sqlite3_bind_xxx()` require you to pass a buffer pointer for the data value. Normally this buffer and its contents must remain valid until a new value is bound to that parameter, or the statement is finalized. Since that might be some time later in the code, these bind functions have a fifth parameter that controls how the buffer memory is handled and possibly released.

If the fifth parameter is either `NULL` or the constant `SQLITE_STATIC`, SQLite will take a hands-off approach and assume the buffer memory is either static or that your application code is taking care of maintaining and releasing any memory.

If the fifth parameter is the constant `SQLITE_TRANSIENT`, SQLite will make an internal copy of the buffer. This allows you to release your buffer immediately (or allow it to go out of scope, if it happens to be on the stack). SQLite will automatically release the internal buffer at an appropriate time.

The final option is to pass a valid `void mem_callback( void* ptr )` function pointer. This callback will be called when SQLite is done with the buffer and wants to release it. If the buffer was allocated with `sqlite3_malloc()` or `sqlite3_realloc()`, you can pass a reference to `sqlite3_free()` directly. If you allocated the buffer with a different set of memory management calls, you'll need to pass a reference to a wrapper function that calls the appropriate memory release function.

Once a value has been bound to a parameter, there is no way to extract that value back out of the statement. If you need to reference a value after it has been bound, you must keep track of it yourself.

To help you figure out what parameter index to use, there are three utility functions:

```
int sqlite3_bind_parameter_count( sqlite3_stmt *stmt )
```

Returns an integer indicating the largest parameter index. If no explicit numeric indexes are used ( `?<number>` ), this will be the number of unique parameters that appear in a statement. If explicit numeric indexes are used, there may be gaps in the number sequence.

```
int sqlite3_bind_parameter_index( sqlite3_stmt *stmt, const char *name )
```

Returns the index of a named parameter. The name must include any leading character (such as “:”) and must be given in UTF-8, even if the statement was prepared from UTF-16. A zero is returned if a parameter with a matching name cannot be found.

```
const char* sqlite3_bind_parameter_name( sqlite3_stmt *stmt, int pidx )
```

Returns the full text representation of a specific parameter. The text is always UTF-8 encoded and includes the leading character.

Using the `sqlite3_bind_parameter_index()` function, you can easily find and bind named parameters. The `sqlite3_bind_xxx()` functions will properly detect an invalid index range, allowing you to look up the index and bind a value in one line:

```
sqlite3_bind_int(stmt, sqlite3_bind_parameter_index(stmt, ":pid"), pid);
```

If you want to clear all of the bindings back to their initial NULL defaults, you can use the function `sqlite3_clear_bindings()`:

```
int sqlite3_clear_bindings( sqlite3_stmt *stmt )
```

Clears all parameter bindings in a statement. After calling, all parameters will have a NULL bound to them. This will cause the memory management callback to be called on any text or BLOB values that were bound with a valid function pointer. Currently, this function always returns `SQLITE_OK`.

If you want to be absolutely sure bound values won't leak from one statement execution to the next, it is best to clear the bindings any time you reset the statement. If you're doing manual memory management on data buffers, you can free any memory used by bound values after this function is called.

## Security and Performance

There are significant security advantages to using bound parameters. Many times people will manipulate SQL strings to substitute the values they want to use. For example, consider building an SQL statement in C using the string function `snprintf()`:

```
snprintf(buf, buf_size,
         "INSERT INTO people( id, name ) VALUES ( %d, '%s' );",
         id_val, name_val);
```

In this case we do need single quotes around the string value, as we're trying to form a literal representation. If we pass in these C values:

```
id_val = 23;
name_val = "Fred";
```

Then we get the following SQL statement in our buffer:

```
INSERT INTO people( id, name ) VALUES ( 23, 'Fred');
```



This seems simple enough, but the danger with a statement like this is that the variables need to be sanitized before they're passed into the SQL statement. For example, consider these values:

```
id_val = 23;
name_val = "Fred' ); DROP TABLE people;";
```

This would cause our `sprintf()` to create the following SQL command sequence, with the individual commands split out onto their own lines for clarity:

```
INSERT INTO people( id, name ) VALUES ( 23, 'Fred' );
DROP TABLE people;
');
```

While that last statement is nonsense, the second statement is cause for concern.

Thankfully, things are not quite as bad as they seem. The `sqlite3_prepare_xxx()` functions will only prepare a single statement (up to the first semicolon), unless you explicitly pass the remainder of the SQL command string to another `sqlite3_prepare_xxx()` call. That limits what can be done in a case like this, unless your code automatically prepares and executes multiple statements from a single command buffer.

Be warned, however, that the interfaces provided by many scripting languages will do exactly that, and will automatically process multiple SQL statements passed in with a single call. The SQLite convenience functions, including `sqlite3_exec()`, will also automatically process multiple SQL commands passed in through a single string. What makes `sqlite3_exec()` particularly dangerous is that the convenience functions don't allow the use of bound values, forcing you to programmatically build SQL command statements and opening you up to problems. Later in the chapter, we'll take a closer look at `sqlite3_exec()` and why it usually isn't the best choice.

Even if SQLite will only process the first command, damage can still be done with subqueries and other commands. Bad input can also force a statement to fail. Consider the result if the name value is:

```
Fred', 'extra junk
```

If you're updating a series of records based off this `id` value, you had better wrap all the commands up in a transaction and be prepared to roll it back if you encounter an error. If you just assume the commands will work, you'll end up with an inconsistent database.

This type of attack is known as an *SQL injection attack*. An SQL injection attack inserts SQL command fragments into data values, causing the database to execute arbitrary SQL commands. Unfortunately, it is *extremely* common for websites to be susceptible to this kind of attack. It also borders on inexcusable, because it is typically very easy to avoid.

One defense against SQL injections is to try to sanitize any string values received from an untrusted source. For example, you might try to substitute all single quote characters with two single quote characters (the standard SQL escape mechanism). This can get quite complex, however, and you're putting utter faith in the code's ability to correctly sanitize untrusted strings.

A much easier way to defend yourself against SQL injections is to use SQL statement parameters. Injection attacks depend on a data value being represented as a literal value in an SQL command statement. The attack only works if the attack value is passed through the SQL parser, where it alters the meaning of the surrounding SQL commands.

In the case of SQL parameters, the bound values are never passed through the SQL parser. An SQL statement is only parsed when the command is prepared. If you're using parameters, the SQL engine parses only the parameter tokens. Later, when you bind a value to a specific parameter, that value is bound directly in its native format (i.e. string, integer, etc.) and is not passed through the SQL parser. As long as you're careful about how you extract and display the string, it is perfectly safe to directly bind an untrusted string value to a parameter value without fear of an SQL injection.

Besides avoiding injection attacks, parameters can also be faster and use less memory than string manipulations. Using a function such as `snprintf()` requires an SQL command template, and a sufficiently large output buffer. The string manipulation functions also need working memory, plus you may need additional buffers to copy and sanitize values. Additionally, a number of datatypes, such as integers and floating-point numbers (and especially BLOBs), often take up significantly more space in their string representation. This further increases memory usage. Finally, once the final command buffer has been created, all the data needs to be passed through the SQL parser, where the literal data values are converted back into their native format and stored in additional buffers.

Compare that to the resource usage of preparing and binding a statement. When using parameters, the SQL command statement is essentially static, and can be used as is, without modification or additional buffers. The parser doesn't need to deal with converting and storing literal values. In fact, the data values normally never leave their native format, further saving time and memory by avoiding conversion in and out of a string representation.

Using parameters is the safe and wise choice, even for situations when a statement is only used once. It may take a few extra lines of code, but the process will be safer, faster, and more memory efficient.

## Example

This example executes an `INSERT` statement. Although this statement is only executed once, it still uses bind parameters to protect against possible injection attacks. This eliminates the need to sanitize the input value.

The statement is first prepared with a statement parameter. The data value is then bound to the statement parameter before we execute the prepared statement:

```
char          *data = ""; /* default to empty string */
sqlite3_stmt  *stmt = NULL;
int           idx = -1;

/* ... set "data" pointer ... */
/* ... open database ... */

rc = sqlite3_prepare_v2( db, "INSERT INTO tbl VALUES ( :str )", -1, &stmt, NULL );
if ( rc != SQLITE_OK ) exit( -1 );

idx = sqlite3_bind_parameter_index( stmt, ":str" );
sqlite3_bind_text( stmt, idx, data, -1, SQLITE_STATIC );

rc = sqlite3_step( stmt );
if ( ( rc != SQLITE_DONE ) && ( rc != SQLITE_ROW ) ) exit ( -1 );

sqlite3_finalize( stmt );

/* ... close database ... */
```

In this case we look for either an `SQLITE_DONE` or an `SQLITE_ROW` return value. Both are possible. Although the `INSERT` itself will be fully executed on the first call to `sqlite3_step()`, if `PRAGMA count_changes` is enabled, then the statement may return a value. In this case, we want to ignore any potential return value without triggering an error, so we must check for both possible return codes. For more details, see [count\\_changes](#) in [Appendix F](#).

## Potential Pitfalls

It is important to understand that all parameters must have some literal associated with them. As soon as you prepare a statement, all the parameters are set to `NULL`. If you fail to bind an alternate value, the parameter still has a literal `NULL` associated with it. This has a few ramifications that are not always obvious.

The general rule of thumb is that bound parameters act as literal string substitutions. Although they offer additional features and protections, if you're trying to figure out the expected behavior of a parameter substitution, it is safe to assume you'll get the exact same behavior as if the parameter was a literal string substitution.

In the case of an `INSERT` statement, there is no way to force a default value to be used. For example, if you have the following statement:

```
INSERT INTO membership ( pid, gid, type ) VALUES ( :pid, :gid, :type );
```

Even if the `type` column has a default value available, there is no way this statement can use it. If you fail to bind a value to the `:type` parameter, a `NULL` will be inserted, rather than the default value. The only way to insert a default value into the `type` column is to use a statement that doesn't reference it, such as:

```
INSERT INTO membership ( pid, gid ) VALUES ( :pid, :gid );
```

This means that if you're heavily dependent on database-defined default values, you may need to prepare several variations of an `INSERT` statement to cover the different cases when different data values are available. Of course, if your application code is aware of the proper default values, it can simply bind that value to the proper parameter.

The other area where parameters can cause surprises is in `NULL` comparisons. For example, consider the statement:

```
SELECT * FROM employee WHERE manager = :manager;
```

This works for normal values, but if a `NULL` is bound to the `:manager` parameter, no rows will ever be returned. If you need the ability to test for a `NULL` in the `manager` column, make sure you use the `IS` operator:

```
SELECT * FROM employee WHERE manager IS :manager;
```

For more details, see [IS](#) in [Appendix D](#).

This behavior also makes it tricky to “stack” conditionals. For example, if you have the statement:

```
SELECT * FROM employee WHERE manager = :manager AND project = :project;
```

you must provide a meaningful value for both `:manager` and `:project`. If you want the ability to search on a `manager`, on a `project`, or on a `manager` and a `project`, you need to prepare multiple statements, or you need to add a bit more logic:

```
...WHERE ( manager = :manager OR :manager IS NULL )
        AND ( project = :project OR :project IS NULL );
```

This query will ignore one (or both) of the value conditions if you assign a `NULL` to the appropriate parameters. This expression won't let you explicitly search for `NULL`s, but that can be done with additional parameters and logic. Preparing more flexible statements reduces the number of unique statements you need to manage, but it also tends to make them more complex and can make them run slower. If they get too complex, it might make more sense to simply define a new set of statements, rather than adding more and more parameter logic to the same statement.

## Convenience Functions

SQLite includes a number of convenience functions that can be used to prepare, step, and finalize an SQL statement in one call. Most of these functions exist for historical reasons and, as the name says, convenience.

While they're not fully deprecated, there are a number of reasons why their use is not exactly encouraged. First off, understand that there is nothing special under the hood. Both of these functions eventually call the same `sqlite3_prepare_xxx()`, `sqlite3_step()`, and `sqlite3_finalize()` calls that are available in the public API. These functions are not faster, nor are they more efficient.

Second, since the API doesn't support the use of bound parameters, you're forced to use string manipulations to build your SQL commands. That means these functions are slower to process and much more vulnerable to SQL injection attacks. This is particularly dangerous because all the convenience functions are designed to automatically process multiple SQL statements from a single command string. If input strings are not properly sanitized, this situation effectively gives anyone providing input data full access to the database engine, including the ability to delete data or drop whole tables.

These functions also tend to be a bit slower. All results are returned in a string representation, without any kind of type information. This can make it difficult to determine the type of a return value, and can lead to a lot of extra type conversions.

For all their disadvantages, there is still the simple fact that these functions are very convenient. If you're just trying to throw together a quick and dirty snippet of code, these functions provide an easy means of doing that. They're also perfectly acceptable for DDL commands, such as `CREATE TABLE`. For any type of DML command, especially those that involve values from unsanitized sources, I strongly recommend using the normal prepare, step, and finalize routines. You'll end up with safer code and better performance.

The first function allows for fairly generic execution of any SQL command string.

```
int sqlite3_exec( sqlite3 *db, const char *sql,
                 callback_ptr, void *userData, char **errMsg )
```

Prepares and executes one or more SQL statements, calling the optional callback for each result set row for each statement. The first parameter is a valid database connection. The second parameter is a UTF-8 encoded string that consists of one or more SQL statements. The third parameter is a pointer to a callback function. The prototype of this function is given below. This function pointer can be NULL. The fourth parameter is a user-data pointer that will be passed to the callback. The value can be whatever you want, including NULL. The fifth parameter is a reference to a character pointer. If an error is generated and this parameter is non-NULL, `sqlite3_exec()` will allocate a string buffer and return it. If the passed-back pointer is non-NULL, you are responsible for releasing the buffer with `sqlite3_free()` once you are done with it.

If the SQL string consists of multiple SQL statements separated by semicolons, each statement will be executed in turn.

If the call is successful and all statements are processed without errors, `SQLITE_OK` will be returned. Otherwise, just about any of the other return codes are possible, since this one function runs through the whole statement preparation and execution process.

The `sqlite3_exec()` function is reasonably all encompassing, and can be used to execute any SQL statement. If you're executing a table query and want to access the result set, you will need to supply a function pointer that references a user-defined callback. This callback will be called once for each row returned. If you're executing an SQL statement that does not normally return any database value, there is no need to provide a callback function. The success or failure of the SQL command will be indicated in the return value.

The `sqlite3_exec()` function makes any database results available through a user-defined callback function. As each result row is computed, the callback is called to make the row data available to your code. Essentially, each internal call to `sqlite3_step()` that results in a return value of `SQLITE_ROW` results in a callback.

The format of the callback looks like this:

```
int user_defined_exec_callback( void *userData, int numCol,
                               char **colData, char **colName )
```

This function is not part of the SQLite API. Rather, this shows the required format for a user-defined `sqlite3_exec()` callback. The first parameter is the user-data pointer passed in as the fourth parameter to `sqlite3_exec()`. The second parameter indicates how many columns exist in this row. The third and fourth parameters both return an array of strings (char pointers). The third parameter holds the data values for this row, while the fourth parameter holds the column names. All values are returned as strings. There is no type information.

Normally, the callback should return a zero value. If a nonzero value is returned, execution is stopped and `sqlite3_exec()` will return `SQLITE_ABORT`.

The second, third, and fourth parameters act very similar to the traditional C variables `argc` and `argv` (and an extra `argv`) in `main( int argc, char **argv )`, the traditional start to every C program. The column value and name arrays will always be the same size for any given callback, but the specific size of the arrays and the column names can change over the course of processing a multi-statement SQL string. There is no need to release any of these values. Once your callback function returns, `sqlite3_exec()` will handle all the memory management.

If you'd prefer not to mess with a callback, you can use `sqlite3_get_table()` to extract a whole table at once. Be warned, however, that this can consume a large amount of memory, and must be used carefully.

While you can technically call `sqlite3_get_table()` with any SQL command string, it is specifically designed to work with `SELECT` statements.

```
int sqlite3_get_table( sqlite3 *db, const char *sql, char ***result,
                      int *numRow, int *numCol, char **errMsg );
```

Prepares and executes an SQL command string, consisting of one or more SQL statements. The full contents of the result set(s) is returned in an array of UTF-8 strings.

The first parameter is a database connection. The second parameter is a UTF-8 encoded SQL command string that consists of one or more SQL statements. The third parameter is a reference to a one-dimensional array of strings (char pointers). The results of the query are passed back through this reference. The fourth and fifth parameters are integer references that pass back the number of rows and the number of columns, respectively, in the result array. The sixth and final parameter is a reference to a character string, and is used to return any error message.

The result array consists of ( $\text{numCol} * (\text{numRow} + 1)$ ) entries. Entries zero through  $\text{numCol} - 1$  hold the column names. Each additional set of  $\text{numCol}$  entries holds one row worth of data.

If the call is successful and all statements are processed without errors, `SQLITE_OK` will be returned. Otherwise, just about any of the other return codes are possible, since this one function runs through the whole statement preparation and execution process.

```
void sqlite3_free_table( char **result )
```

Correctly frees the memory allocated by a successful call to `sqlite3_get_table()`. Do not attempt to free this memory yourself.

As indicated, you must release the result of a call to `sqlite3_get_table()` with a call to `sqlite3_free_table()`. This will properly release the individual allocations used to build the result value. As with `sqlite3_exec()`, you must call `sqlite3_free()` on any `errMsg` value that is returned.

The result array is a one-dimensional array of character pointers. You must compute your own offsets into the array using the formula:

```
/* offset to access column C of row R of **result */
int  offset = ((R + 1) * numCol) + C;
char *value = result[offset];
```

The “+ 1” used to compute the row offset is required to skip over the column names, which are stored in the first row of the result. This assumes that the first row and column would be accessed with an index of zero.

As a convenience function, there is nothing special about `sqlite3_get_table()`. In fact, it is just a wrapper around `sqlite3_exec()`. It offers no additional performance benefits over the prepare, step, and finalize interfaces. In fact, between all the type conversions inherent in `sqlite3_exec()`, and all the memory allocations, `sqlite3_get_table()` has substantial overhead over other methods.

Since `sqlite3_get_table()` is a wrapper around `sqlite3_exec()`, it is possible to pass in an SQL command string that consists of multiple SQL statements. In the case of `sqlite3_get_table()`, this must be done with care, however.

If more than one `SELECT` statement is passed in, there is no way to determine where one result set ends and the next begins. All the resulting rows are run together as one large result array. All of the statements must return the same number of columns, or the whole `sqlite3_get_table()` command will fail. Additionally, only the first statement will return any column names. To avoid these issues, it is best to call `sqlite3_get_table()` with single SQL commands.

There are a number of reasons why these convenience functions may not be the best choice. Their use requires building an SQL command statement using string manipulation functions, and that process tends to be error prone. However, if you insist, your best bet is to use one of SQLite's built-in string-building functions: `sqlite3_mprintf()`, `sqlite3_vmprintf()`, or `sqlite3_snprintf()`. See [Appendix G](#) for more details.

## Result Codes and Error Codes

You may have noticed that I've been fairly quiet about the result codes that can be expected from a number of these API calls. Unfortunately, error handling in SQLite is a bit complex. At some point, it was recognized that the original error reporting mechanism was a bit too generic and somewhat difficult to use. To address these concerns, a newer "extended" set of error codes was added, but this new system had to be layered on top of the existing system without breaking backward compatibility. As a result, we have both the older and newer error codes, as well as specific API calls that will alter the meaning of some of the codes. This all makes for a somewhat complex situation.

### Standard Codes

Before we get into when things go wrong, let's take a quick look at when things go right. Generally, any API call that simply needs to indicate, "that worked," will return the constant `SQLITE_OK`. Not all non-`SQLITE_OK` return codes are errors, however. Recall that `sqlite3_step()` returns `SQLITE_ROW` or `SQLITE_DONE` to indicate specific return state.

[Table 7-2](#) provides a quick overview of the standard error codes. At this point in the development life cycle, it is unlikely that additional standard error codes will be added. Additional extended error codes may be added at any time, however.

*Table 7-2. SQLite standard return codes*

Return code constant	Return code meaning
<code>SQLITE_OK</code>	Operation successful
<code>SQLITE_ERROR</code>	Generic error
<code>SQLITE_INTERNAL</code>	Internal SQLite library error



Return code constant	Return code meaning
SQLITE_PERM	Access permission denied
SQLITE_ABORT	User code or SQL requested an abort
SQLITE_BUSY	A database file is locked (usually recoverable)
SQLITE_LOCKED	A table is locked
SQLITE_NOMEM	Memory allocation failed
SQLITE_READONLY	Attempted to write to a read-only database
SQLITE_INTERRUPT	sqlite3_interrupt() was called
SQLITE_IOERR	Some type of I/O error
SQLITE_CORRUPT	Database file is malformed
SQLITE_FULL	Database is full
SQLITE_CANTOPEN	Unable to open requested database file
SQLITE_EMPTY	Database file is empty
SQLITE_SCHEMA	Database schema has changed
SQLITE_TOOBIG	TEXT or BLOB exceeds limit
SQLITE_CONSTRAINT	Abort due to constraint violation
SQLITE_MISMATCH	Datatype mismatch
SQLITE_MISUSE	API used incorrectly
SQLITE_NOLFS	Host OS cannot provide required functionality
SQLITE_AUTH	Authorization denied
SQLITE_FORMAT	Auxiliary database format error
SQLITE_RANGE	Bad bind parameter index
SQLITE_NOTADB	File is not a database

Many of these errors are fairly specific. For example, `SQLITE_RANGE` will only be returned by one of the `sqlite3_bind_xxx()` functions. Other codes, like `SQLITE_ERROR`, provide almost no information about what went wrong.

Of specific interest to the developer is `SQLITE_MISUSE`. This indicates an attempt to use a data structure or API call in an incorrect or otherwise invalid way. For example, trying to bind a new value to a prepared statement that is in the middle of an `sqlite3_step()` sequence would result in a misuse error. Occasionally, you'll get an `SQLITE_MISUSE` that results from failing to properly deal with a previous error, but many times it is a good indication that there is some more basic conceptual misunderstanding about how the library is designed to work.

## Extended Codes

The extended codes were added later in the SQLite development cycle. They provide more specific details on the cause of an error. However, because they can change the value returned by a specific error condition, they are turned off by default. You need to explicitly enable them for the older API calls, indicating to the SQLite library that you're aware of the extended error codes and willing to accept them.

All of the standard error codes fit into the least-significant byte of the integer value that is returned by most API calls. The extended codes are all based off one of the standard error codes, but provide additional information in the higher-order bytes. In this way, the extended codes can provide more specific details about the cause of the error. Currently, most of the extended error codes provide specific details for the `SQLITE_IOERR` result. You can find a full list of the extended error codes at [http://sqlite.org/c3ref/c\\_ioerr\\_access.html](http://sqlite.org/c3ref/c_ioerr_access.html).

## Error Functions

The following APIs are used to enable the extended error codes and extract more information about any current error conditions.

```
int sqlite3_extended_result_codes( sqlite3 *db, int onoff )
```

Turns extended result and error codes on or off for this database connection. Database connections returned by any version of `sqlite3_open_xxx()` will have extended codes off by default. You can turn them on by passing a nonzero value in the second parameter. This function always returns `SQLITE_OK`—there is no way to extract the current result code state.

```
int sqlite3_errcode( sqlite3 *db )
```

If a database operation returns a non-`SQLITE_OK` status, a subsequent call to this function will return the error code. By default, this will only return a standard error code, but if extended result codes have been enabled, it may also return one of the extended codes.

```
int sqlite3_extended_errcode( sqlite3 *db )
```

Essentially the same as `sqlite3_errcode()`, except that extended results are *always* returned.

```
const char* sqlite3_errmsg( sqlite3 *db )
```

```
const void* sqlite3_errmsg16( sqlite3 *db )
```

Returns a null-terminated, human-readable, English language error string that is encoded in UTF-8 or UTF-16. Any additional calls to the SQLite APIs using this database connection may result in these pointers becoming invalid, so you should either use the string before attempting any other operations, or you should make a private copy. It is also possible for these functions to return a `NULL` pointer, so check the result value before using it. Extended error codes are not used.

It is acceptable to leave extended error codes off and intermix calls to `sqlite3_errcode()` and `sqlite3_extended_errcode()`.

Because the error state is stored in the database connection, it is easy to end up with race conditionals in a threaded application. If you're sharing a database connection across threads, it is best to wrap your core API call and error-checking code in a critical section. You can grab the database connection's mutex lock with `sqlite3_db_mutex()`. See [sqlite3\\_db\\_mutex\(\)](#) in [Appendix G](#) for more details.

Similarly, the error handling system can't deal with multiple errors. If there is an error that goes unchecked, the next call to a core API function is likely to return `SQLITE_MISUSE`, indicating the attempt to use an invalid data structure. In this and similar situations where multiple errors have been encountered, the state of the error message can become inconsistent. You need to check and handle any errors after each API call.

## Prepare v2

In addition to the standard and extended codes, the newer `_v2` versions of `sqlite3_prepare_xxx()` change the way prepared statement errors are processed. Although the newer and original versions of `sqlite3_prepare_xxx()` share the same parameters, the `sqlite3_stmt` returned by the `_v2` versions is slightly different.

The most noticeable difference is in how errors from `sqlite3_step()` are handled. For statements prepared with the original version of `sqlite3_prepare_xxx()`, the majority of errors within `sqlite3_step()` will return the rather generic `SQLITE_ERROR`. To find out the specifics of the situation, you had to call `sqlite3_reset()` or `sqlite3_finalize()` to extract a more detailed error code. This would, of course, cause the statement to be reset or finalized, which limited your recovery options.

Things work a bit differently if the statement was prepared with the `_v2` version. In that case, `sqlite3_step()` will return the specific error directly. The call `sqlite3_step()` may return a standard code or an extended code, depending if extended codes are enabled or not. This allows the developer to extract the error directly, and provides for more recovery options.

The other major difference is how database schema changes are handled. If any Data Definition Language command (such as `DROP TABLE`) is issued, there is a chance the prepared statement is no longer valid. For example, the prepared statement may refer to a table or index that is no longer there. The only way to resolve any possible problems is to reprepare the statement.

The `_v2` versions of `sqlite3_prepare_xxx()` make a copy of the SQL statement used to prepare a statement. (This SQL can be extracted. See [sqlite3\\_sql\(\)](#) in [Appendix G](#) for more details.) By keeping an internal copy of the SQL, a statement is able to reprepare itself if the database schema changes. This is done automatically any time SQLite detects the need to rebuild the statement.

The statements created with the original version of `prepare` didn't save a copy of the SQL command, so they were unable to recover themselves. As a result, any time the schema changed, an API call involving any previously prepared statement would return `SQLITE_SCHEMA`. The program would then have to reprepare the statement using the original SQL and try again. If the schema change was significant enough that the SQL was no longer valid, `sqlite3_prepare_xxx()` would return an appropriate error when the program attempted to reprepare the SQL command.

Statements created with the `_v2` version of `prepare` can still return `SQLITE_SCHEMA`. If a schema change is detected and the statement is unable to automatically reprepare itself, it will still return `SQLITE_SCHEMA`. However, under the `_v2` `prepare`, this is now considered a fatal error, as there is no way to recover the statement.

Here is a side-by-side comparison of the major differences between the original and `_v2` version of `prepare`:

Statement prepared with original version	Statement prepared with v2 version
Created with <code>sqlite3_prepare()</code> or <code>sqlite3_prepare16()</code> .	Created with <code>sqlite3_prepare_v2()</code> or <code>sqlite3_prepare16_v2()</code> .
Most errors in <code>sqlite3_step()</code> return <code>SQLITE_ERROR</code> .	<code>sqlite3_step()</code> returns specific errors directly.
<code>sqlite3_reset()</code> or <code>sqlite3_finalize()</code> must be called to get full error. Standard or extended error codes may be returned.	No need to call anything additional. <code>sqlite3_step()</code> may return a standard or extended error code.
Schema changes will make any statement function return <code>SQLITE_SCHEMA</code> . Application must manually finalize and reprepare statement.	Schema changes will make the statement reprepare itself.
If application-provided SQL is no longer valid, the prepare will fail.	If internal SQL is no longer valid, any statement function will return <code>SQLITE_SCHEMA</code> . This is a statement-fatal error, and the only choice is to finalize the statement.
Original SQL is not associated with statement.	Statement keeps a copy of SQL used to prepare. SQL can be recovered with <code>sqlite3_sql()</code> .
Limited debugging.	<code>sqlite3_trace()</code> can be used.

Because the `_v2` error handling is a lot simpler, and because of the ability to automatically recover from schema changes, it is strongly recommended that all new development use the `_v2` versions of `sqlite3_prepare_xxx()`.

## Transactions and Errors

Transactions and checkpoints add a unique twist to the error recovery process. Normally, SQLite operates in autocommit mode. In this mode, SQLite automatically wraps each SQL command in its own transaction. In terms of the API, that's the time from when `sqlite3_step()` is first called until `SQLITE_DONE` is returned by `sqlite3_step()` (or when `sqlite3_reset()` or `sqlite3_finalize()` is called).

If each statement is wrapped up in its own transaction, error recovery is reasonably straightforward. Any time SQLite finds itself in an error state, it can simply roll back the current transaction, effectively canceling the current SQL command and putting the database back into the state it was in prior to the command starting.

Once a `BEGIN TRANSACTION` command is executed, SQLite is no longer in autocommit mode. A transaction is opened and held open until the `END TRANSACTION` or `COMMIT TRANSACTION` command is given. This allows multiple commands to be wrapped up in the same transaction. While this is useful to group together a series of discrete commands into an atomic change, it also limits the options SQLite has for error recovery.

When an error is encountered during an explicit transaction, SQLite attempts to save the work and undo just the current statement. Unfortunately, this is not always possible. If things go seriously wrong, SQLite will sometimes have no choice but to roll back the current transaction.

The errors most likely to result in a rollback are `SQLITE_FULL` (database or disk full), `SQLITE_IOERR` (disk I/O error or locked file), `SQLITE_BUSY` (database locked), `SQLITE_NOMEM` (out of memory), and `SQLITE_INTERRUPT` (interrupt requested by application). If you're processing an explicit transaction and receive one of these errors, you need to deal with the possibility that the transaction was rolled back.

To figure out which action was taken by SQLite, you can use the `sqlite3_get_autocommit()` function.

```
int sqlite3_get_autocommit( sqlite3 *db )
```

Returns the current commit state. A nonzero return value indicates the database is in autocommit mode, and not in an explicit transaction. A zero value indicates the database is currently inside an explicit transaction.

If SQLite was forced to do a full rollback, the database will once again be in autocommit mode. If the database is not in autocommit mode, it must still be in a transaction, indicating that a rollback was not required.

Although there are situations when it is possible to recover and continue a transaction, it is considered a best practice to always issue a `ROLLBACK` if one of these errors is encountered. In situations when SQLite was already forced to roll back the transaction and has returned to autocommit mode, the `ROLLBACK` will do nothing but return an error that can be safely ignored.

## Database Locking

SQLite employs a number of different locks to protect the database from race conditions. These locks allow multiple database connections (possibly from different processes) to access the same database file simultaneously without fear of corruption. The locking system is used for both autocommit transactions (single statements) as well as explicit transactions.

The locking system involves several different tiers of locks that are used to reduce contention and avoid deadlocking. The details are somewhat complex, but the system allows multiple connections to read a database file in parallel, but any write operation requires full, exclusive access to the entire database file. If you want the full details, see <http://www.sqlite.org/lockingv3.html>.

Most of the time the locking system works reasonably well, allowing applications to easily and safely share the database file. If coded properly, most write operations only last a fraction of a second. The library is able to get in, make the required modifications, verify them, and then get out, quickly releasing any locks and making the database available to other connections.

However, if more than one connection is trying to access the same database at the same time, sooner or later they'll bump into each other. Normally, if an operation requires a lock that the database connection is unable to acquire, SQLite will return the error `SQLITE_BUSY` or, in some more extreme cases, `SQLITE_IOERR` (extended code `SQLITE_IOERR_BLOCKED`). The functions `sqlite3_prepare_xxx()`, `sqlite3_step()`, `sqlite3_reset()`, and `sqlite3_finalize()` can all return `SQLITE_BUSY`. The functions `sqlite3_backup_step()` and `sqlite3_blob_open()` can also return `SQLITE_BUSY`, as these functions use `sqlite3_prepare_xxx()` and `sqlite3_step()` internally. Finally, `sqlite3_close()` may return `SQLITE_BUSY` if there are unfinalized statements associated with the database connection, but that's not related to locking.

Gaining access to a needed lock is often a simple matter of waiting until the current holder finishes up and releases the lock. In most cases, this is not a particularly long period of time. The waiting can either be done by the application, which can respond to an `SQLITE_BUSY` by simply trying to reprocess the statement and trying again, or it can be done with a busy handler.

### Busy handlers

A busy handler is a callback function that is called by the SQLite library any time it is unable to acquire a lock, but has determined it is safe to try and wait for it. The busy handler can instruct SQLite to keep trying to acquire the lock, or to give up and return an `SQLITE_BUSY` error.

SQLite includes an internal busy handler that uses a timer. If you set a timeout period, SQLite will keep trying to acquire the locks it requires until the timer expires.

```
int sqlite3_busy_timeout( sqlite3 *db, int millisec )
```

Sets the given database connection to use the internal timer-based busy handler. If the second parameter is greater than zero, the handler is set to use a timeout value provided in milliseconds (thousandths of a second). If the second parameter is zero or negative, any busy handler will be cleared.

If you want to write your own busy handler, you can set the callback function directly:

```
int sqlite3_busy_handler( sqlite3 *db, callback_func_ptr, void *udp )
```

Sets a busy handler for the given database. The second parameter is a function pointer to the busy handler, and the third parameter is a user-data pointer that is passed to the callback. Setting a NULL function pointer will remove the busy handler.

```
int user_defined_busy_handler_callback( void *udp, int incr )
```

This is not an SQLite library call, but the format of a user-defined busy handler. The first parameter is the user-data pointer passed to `sqlite3_busy_handler()` when the callback was set. The second parameter is a counter that is incremented each time the busy handler is called while waiting for a specific lock.

A return value of zero will cause SQLite to give up and return an `SQLITE_BUSY` error, while a nonzero return value will cause SQLite to keep trying to acquire the lock. If the lock is successfully acquired, command processing will continue. If the lock is not acquired, the busy handler will be called again.

Be aware that each database connection has only one busy handler. You cannot set an application busy handler *and* configure a busy timeout value at the same time. Any call to either of these functions will cancel out the other one.

## Deadlocks

Setting a busy handler will not fix every problem. There are some situations when waiting for a lock will cause the database connection to deadlock. The deadlock happens when a pair of database connections each have some set of locks and both need to acquire additional locks to finish their task. If each connection is attempting to access a lock currently held by the other connection, both connections will stall in a deadlock. This can happen if two database connections both attempt to write to the database at the same time. In this case, there is no point in both database connections waiting for the locks to be released, since the only way to proceed is if one of the connections gives up and releases all of its locks.

If SQLite detects a potential deadlock situation, it will skip the busy handler and will have one of the database connections return `SQLITE_BUSY` immediately. This is done to encourage the applications to release their locks and break the deadlock. Breaking the deadlock is the responsibility of the application(s) involved—SQLite cannot handle this situation for you.

## Avoiding `SQLITE_BUSY`

When developing code for a system that requires any degree of database concurrency, the easiest approach is to use `sqlite3_busy_timeout()` to set a timeout value that is reasonable for your application. Start with something between 250 to 2,000 milliseconds and adjust from there. This will help reduce the number of `SQLITE_BUSY` response codes, but it will not eliminate them.

The only way to completely avoid `SQLITE_BUSY` is to ensure a database never has more than one database connection. This can be done by setting `PRAGMA locking_mode to EXCLUSIVE`.

If this is unacceptable, an application can use transactions to make an `SQLITE_BUSY` return code easier to deal with. If an application can successfully start a transaction with `BEGIN EXCLUSIVE TRANSACTION`, this will eliminate the possibility of getting an `SQLITE_BUSY`. The `BEGIN` itself may return an `SQLITE_BUSY`, but in this case the application can simply reset the `BEGIN` statement with `sqlite3_reset()` and try again. The disadvantage of `BEGIN EXCLUSIVE` is that it can only be started when no other connection is accessing the database, including any read-only transactions. Once an exclusive transaction is started, it also locks out all other connections from accessing the database, including read-only transactions.

To allow more concurrency, an application can use `BEGIN IMMEDIATE TRANSACTION`. If an `IMMEDIATE` transaction is successfully started, the application is very unlikely to receive an `SQLITE_BUSY` until the `COMMIT` statement is executed. In all cases (including the `COMMIT`), if an `SQLITE_BUSY` is encountered, the application can reset the statement, wait, and try again. As with `BEGIN EXCLUSIVE`, the `BEGIN IMMEDIATE` statement itself can return `SQLITE_BUSY`, but the application can simply reset the `BEGIN` statement and try again. A `BEGIN IMMEDIATE` transaction can be started while other connections are reading from the database. Once started, no new writers will be allowed, but read-only connections can continue to access the database up until the point that the immediate transaction is forced to modify the database file. This is normally when the transaction is committed. If all database connections use `BEGIN IMMEDIATE` for all transactions that modify the database, then a deadlock is not possible and all `SQLITE_BUSY` errors (for both the `IMMEDIATE` writers and other readers) can be handled with a retry.

Finally, if an application is able to successfully begin a transaction of any kind (including the default, `DEFERRED`), it should never get an `SQLITE_BUSY` (or risk a deadlock) unless it attempts to modify the database. The `BEGIN` itself may return an `SQLITE_BUSY`, but the application can reset the `BEGIN` statement and try again.

Attempts to modify the database within a `BEGIN DEFERRED` transaction (or within an autocommit) are the only situations when the database may deadlock, and are the only situations when the response to an `SQLITE_BUSY` needs to go beyond simply waiting and trying again (or beyond letting the busy handler deal with it). If an application performs modifications within a deferred transaction, it needs to be prepared to deal with a possible deadlock situation.

### **Avoiding deadlocks**

The rules to avoid deadlocks are fairly simple, although their application can cause significant complexity in code.



First, the easy ones. The functions `sqlite3_prepare_xxx()`, `sqlite3_backup_step()`, and `sqlite3_blob_open()` cannot cause a deadlock. If an `SQLITE_BUSY` code is returned from one of these functions at any time, simply wait and call the function again.

If the function `sqlite3_step()`, `sqlite3_reset()`, or `sqlite3_finalize()` returns `SQLITE_BUSY` from within a deferred transaction, the application must back off and try again. For statements that are not part of an explicit transaction, the prepared statement can simply be reset and re-executed. For statements that are inside an explicit deferred transaction, the whole transaction must be rolled back and started over from the beginning. In most cases, this will happen on the first attempt to modify the database. Just remember that the whole reason for the rollback is that some other database connection needs to modify the database. If an application has done several read operations to prepare a write operation, it would be best to reread that information in a new transaction to confirm the data is still valid.

Whatever you do, don't ignore `SQLITE_BUSY` errors. They can be rare, but they can also be a source of great frustration if handled improperly.

### **When BUSY becomes BLOCKED**

When a database connection needs to modify the database, a lock is placed that makes the database read-only. This allows other connections to continue to read the database, but prevents them from making modifications. The actual changes are held in the database page cache and not yet written to the database file. Writing the changes out would make the changes visible to the other database connections, breaking the isolation rule of transactions. Since the changes have not yet been committed, it is perfectly safe to have them cached in memory.

When all the necessary modifications have been made and the transaction is ready to commit, the writer further locks the database file so that new read-only transactions cannot get started. This allows the existing readers to finish up and release their own database locks. When all readers are finished, the writer should have exclusive access to the database and may finally flush the changes out of the page cache and into the database file.

This process allows read-only transactions to continue running while the write transaction is in progress. The readers need to be locked out only when the writer actually commits its transaction. However, a key assumption in this process is that the changes fit into the database page cache and do not need to be written until the transaction is committed. If the cache fills up with pages that contain pending changes, a writer has no option but to put an exclusive lock on the database and flush the cache prior to the commit stage. The transaction can still be rolled back at any point, but the writer must be given immediate access to the exclusive write lock in order to perform the cache flush.

If this lock is not immediately available, the writer is forced to abort the entire transaction. The write transaction will be rolled back and the extended result code `SQLITE_IOERR_BLOCKED` (standard code `SQLITE_IOERR`) will be returned. Because the transaction is automatically rolled back, there aren't many options for the application, other than to start the transaction over.

To avoid this situation, it is best to start large transactions that modify many rows with an explicit `BEGIN EXCLUSIVE`. This call may fail with `SQLITE_BUSY`, but the application can simply retry the command until it succeeds. Once an exclusive transaction has started, the write transaction will have full access to the database, eliminating the chance of an `SQLITE_IOERR_BLOCKED`, even if the transaction spills out of the cache prior to the commit. Increasing the size of the database cache can also help.

## Utility Functions

The SQLite library contains a number of utility functions that are useful for both application developers, and those working on SQLite extensions. Most of these are not required for basic database tasks, but if your code is strongly tied to SQLite, you may find these particularly useful.

## Version Management

There are several functions available to query the version of the SQLite library. Each API call has a corresponding `#define` macro that declares the same value.

`SQLITE_VERSION`

`const char* sqlite3_libversion( )`

Returns the SQLite library version as a UTF-8 string.

`SQLITE_VERSION_NUMBER`

`int sqlite3_libversion_number( )`

Returns the SQLite library version as an integer. The format is `MNNPPPP`, where *M* is the major version (3, in this case), *N* is the minor number, and *P* is the point release. This format allows for releases up to 3.999.999. If a sub-point release is made, it will not be indicated in this version number.

`SQLITE_SOURCE_ID`

`const char* sqlite3_sourceid( )`

Returns the check-in stamp of the code used in this release. The string consists of a date, time stamp, and an SHA1 hash of the source from the source repository.

If you're building your own application, you can use the `#define` macros and the function calls to verify that you're using the correct header for the available library. The `#define` values come from the header file, and are set when your application is compiled. The function calls return the same values that were baked into the library when it was compiled.

If you're using a dynamic library of some sort, you can use these macros and functions to prevent your application from linking with a library version other than the one it was originally compiled against. This might not be a good thing, however, as it will also prevent upgrades. If you need to lock in a specific version, you should probably be using a static library.

If you want to check the validity of a dynamic library, it might be better to do something like this:

```
if ( SQLITE_VERSION_NUMBER > sqlite3_libversion_number( ) ) {  
    /* library too old; report error and exit. */  
}
```

Remember that the macro will hold the version used when your code was compiled, while the function call will return the version of the SQLite library. In this case, we report an error if the library is older (smaller version) than the one used to compile and build the application code.

## Memory Management

When SQLite needs to dynamically allocate memory, it normally calls the default memory handler of the underlying operating system. This causes SQLite to allocate its memory from the application heap. However, SQLite can also be configured to do its own internal memory management (see [sqlite3\\_config\(\)](#) in [Appendix G](#)). This is especially important on embedded and hand-held devices where memory is limited and overallocation may lead to stability problems.

Regardless, you can access whatever memory manager SQLite is using with these SQLite memory management functions:

`void* sqlite3_malloc( int numBytes )`

Allocates and returns a buffer of the size specified. If the memory cannot be allocated, a NULL pointer is returned. Memory will always be 8-byte (64-bit) aligned.

This is a replacement for the standard C library `malloc()` function.

`void* sqlite3_realloc( void *buffer, int numBytes )`

Used to resize a memory allocation. Buffers can be made larger or smaller. Given a buffer previously returned by `sqlite3_malloc()` and a byte count, `*_realloc()` will allocate a new buffer of the specified size and copy as much of the old buffer as will fit into the new buffer. It will then free the old buffer and return the new buffer. If the new buffer cannot be allocated, a NULL is returned and the original buffer is *not* freed.

If the buffer pointer is NULL, the call is equivalent to a call to `sqlite3_malloc()`. If the `numBytes` parameter is zero or negative, the call is equivalent to a call to `sqlite3_free()`.

This is a replacement for the standard C library `realloc()` function.

```
void sqlite3_free( void *buffer )
```

Releases a memory buffer previously allocated by `sqlite3_malloc()` or `sqlite3_realloc()`. Also used to free the results or buffers of a number of SQLite API functions that call `sqlite3_malloc()` internally.

This is a replacement for the standard C library `free()` function.

While a number of SQLite calls require the use of `sqlite3_free()`, application code is free to use whatever memory management is most appropriate. Where these functions become extremely useful is in writing custom functions, virtual tables, or any type of loadable module. Since this type of code is meant to operate in any SQLite environment, you will likely want to use these memory management functions to ensure the maximum portability for your code.

## Summary

With the information in this chapter, you should be able to write code that opens a database file and executes SQL commands against it. With that ability, and the right SQL commands, you should be able to create new databases, specify tables, insert data, and build complex queries. For a large number of applications, this is enough to service most of their database needs.

The next chapters look at more advanced features of the SQLite C API. This includes the ability to define your own SQL functions. That will enable you to extend the SQL used by SQLite with simple functions, as well as aggregators (used with `GROUP BY`) and sorting collations. Additional chapters will look at how to implement virtual tables and other advanced features.

# **Additional Features and APIs**

This chapter touches on a number of different areas, mostly having to do with features and interfaces that go beyond the basic database engine. The first section covers the SQLite time and date features, which are provided as a small set of scalar functions. We'll also briefly look at some of the standard extensions that ship with SQLite, such as the ICU internationalization extension, the FTS3 text search module, and the R\*Tree module. We'll also be looking at some of the alternate interfaces available for SQLite in different scripting languages and other environments. Finally, we'll wrap things up with a quick discussion on some of the things to watch out for when doing development on mobile or embedded systems.

## **Date and Time Features**

Most relational database products have several native datatypes that deal with recording dates, times, timestamps, and durations of all sorts. SQLite does not. Rather than having specific datatypes, SQLite provides a small set of time and date conversion functions. These functions can be used to convert time, date, or duration information to or from one of the more generic datatypes, such as a number or a text value.

This approach fits well with the simple and flexible design goals of SQLite. Dates and times can get extremely complicated. Odd time zones and changing daylight saving time (DST) rules can complicate time values, while dates outside of the last few hundred years are subject to calendaring systems that have been changed and modified throughout history. Creating a native type would require picking a specific calendaring system and a specific set of conversion rules that may or may not be suitable for the task at hand. This is one of the reasons a typical database has so many different time and date datatypes.

Using external conversion functions is much more flexible. The developer can choose a format and datatype that best fits the needs of the application. Using the simpler underlying datatypes is also a much better fit for SQLite’s dynamic typing system. A more generic approach also keeps the internal code simpler and smaller, which is a plus for most SQLite environments.

## Application Requirements

When creating date and time data values, there are a few basic questions that need to be answered. Many of these seem obvious enough, but skipping over them too quickly can lead to big problems down the road.

First, you need to figure out what you’re trying to store. It might be a time of day, such as a standalone hour, minute, second value without any associated date. You may need a date record, that refers to a specific day, month, year, but has no associated time. Many applications require timestamps, which include both a date and time to mark a specific point in time. Some applications need to record a specific day of the year, but not for a specific year (for example, a holiday). Many applications also use durations (time deltas). Even if the application doesn’t store durations or offsets, they are often computed for display purposes, such as the amount of time between “now” and a specific event.

It is also worth considering the range and precision required by your application. As already discussed, dates in the far past (or far future) are poorly represented by some calendaring systems. A database that holds reservations for a conference room may require minute precision, while a database that holds network packet dumps may require precision of a microsecond or better.

## Representations

As with many other datatypes, the class of data an application needs to store, along with the required range and precision, often drives the decision on what representation to use. The two most common representations used by SQLite are some type of formatted text-based value or a floating-point value.

### Julian Day

The simplest and most compact representation is the Julian Day. This is a single floating-point value used to count the number of days since noon, Greenwich time, on 24 November 4714 BCE. SQLite uses the proleptic Gregorian calendar for this representation. The Julian value for midnight, 1 January 2010 is 2455197.5. When stored as a 64-bit floating-point value, modern age dates have a precision a tad better than one millisecond.

Many developers have never encountered the Julian Day calendar, but conceptually it is not much different than the more familiar POSIX `time()` value—it just uses a different value (days, rather than seconds) and a different starting point.

Julian Day values have a relatively compact storage format and are fairly easy to work with. Durations and differences are simple and efficient to calculate, and use the same data representation as points in time. Values are automatically normalized and can be utilized with simple mathematical operations. Julian values are also able to express a very broad range of dates, making them useful for historic records. The main disadvantage is that they require conversion before being displayed.

### **Text values**

The other popular representation is a formatted text value. These are typically used to hold a date value, a time value, or a combination of both. Although SQLite recognizes a number of formats, most commonly dates are given in the format `YYYY-MM-DD`, while times are formatted `HH:MM:SS`, using an hour value of 00 to 23. If a full timestamp is required, these values can be combined. For example, `YYYY-MM-DD HH:MM:SS`. Although this style of date may not be the most natural representation, these formats are based off the ISO 8601 international standard for representing dates and times. They also have the advantage of sorting chronologically using a simple string sort.

The main advantage of using a text representation is that they are very easy to read. The stored values do not require any kind of translation and can be easily browsed and understood in their native format. You can also pick and choose what parts of the data value are required, storing only a date or only a time of day, making it a bit more clear about the intention of the value. Or, at least, that would be true if it wasn't for the time zone issue. As we'll see, times and dates are rarely stored relative to the local time zone, so even text values usually require conversion before being displayed.

The major disadvantage of text values is that any operation (other than display) requires a significant amount of data conversion. Time and date conversions require some complex math, and can make a noticeable impact in the performance of some applications. For example, moving a date one week into the future requires a conversion of the original date into some generalized format, offsetting the value, and converting it back into an appropriate text value. Calculating durations also requires a significant amount of conversion. The conversion cost may not be significant for a simple update or insert, but it can make a very noticeable difference if found in a search conditional.

Text values also require careful normalization of all input values into a standardized format. Many operations, such as sorts and simple comparisons, require that values use the *exact* same format. Alternate formats can result in equivalent time values being represented by nonequivalent text values. This can lead to inconsistent results from any procedures that operate directly on the text representation. The problem is not just limited to single columns. If a time or date value is used as a key or join column, these operations will only work properly if all of the time and date values use the same format.

For all these concerns, there is still no denying that text values are the easiest to display and debug. While there is significant value in this, make sure you consider the full range of pros and cons of text values (or any other format) before you make a choice.

## Time zones

You may have noticed that none of these formats support a time zone field. SQLite assumes all time and date information is stored in *UTC*, or Coordinated Universal Time. UTC is essentially Greenwich Mean Time, although there are some minor technical differences.

There are some significant advantages to using UTC time. First and foremost, UTC is unaffected by location. This may seem like a minor thing, but if your database is sitting on a mobile device, it is going to move. Occasionally, it is going to move across time zones. Any displayed time value better shift with the device.

If your database is accessible over the Internet, chances are good it will be accessed from more than one time zone. In short, you can't ignore the time zone issue, and sooner or later you're going to have to translate between time zones. Having a universal base format makes this process much easier.

Similarly, UTC is not affected by Daylight Saving Time. There are no shifts, jumps, or repeats of UTC values. DST rules are extremely complex, and can easily differ by location, time of year, or even the year itself, as switch-over times are shifted and moved. DST essentially adds a second, calendar-sensitive time zone to any location, compounding the problems of location and local time conversions. All of these issues can create a considerable number of headaches.

In the end, there are very few justifiable reasons to use anything except UTC. As the name implies, it provides a universal time system that best represents unique moments in time without any context or translation. It might seem silly to convert values to UTC as you input them, and convert them back to local time to display them, but it has the advantage of working correctly, even if the local time zone changes or the DST state changes. Thankfully, SQLite makes all of these conversions simple.

## Time and Date Functions

Nearly all of the time and date functionality within SQLite comes from five SQL functions. One of these functions is essentially a universal translator, designed to convert nearly any time or date format into any other format. The other four functions act as convenience wrappers that provide a fixed, predefined output format.

In addition to the conversion functions, SQLite also provides a three literal expressions. When an expression is evaluated, these literals will be translated into an appropriate time value that represents "now."



## Conversion Function

The main utility to manipulate time and date values is the `strftime()` SQL function:

```
strftime( format, time, modifier, modifier... )
```

The `strftime()` SQL function is modeled after the POSIX `strftime()` C function. It uses `printf()` style formatting markers to specify an output string. The first parameter is the format string, which defines the format of the returned text value. The second parameter is a source time value that represents the base input time. This is followed by zero or more modifiers that can be used to shift or translate the input value before it is formatted. Typically all of these parameters are text expressions or text literals, although the time value may be numeric.

In addition to any literal characters, the format string can contain any of the following markers:

- `%d` — day of the month (*DD*), 01-31
- `%f` — seconds with fractional part (*SS.sss*), 00-59 plus decimal portion
- `%H` — hour (*HH*), 00-23
- `%j` — day of the year (*NNN*), 001-366
- `%J` — Julian day number (*DDDDDDD.dddddd*)
- `%m` — month (*MM*), 01-12
- `%M` — minute (*MM*), 00-59
- `%s` — seconds since 1970-01-01 (POSIX time value)
- `%S` — seconds (*SS*), 00-59
- `%w` — day of the week (*N*), 0-6, starting with Sunday as 0
- `%W` — week of the year (*WW*), 00-53
- `%Y` — year (*YYYY*)
- `%%` — a literal %

For example, the time format *HH:MM:SS.sss* (including fractional seconds) can be represented by the format string `'%H:%M:%f'`.

SQLite understands a number of input values. If the format of the time string is not recognized and cannot be decoded, `strftime()` will return NULL. All of the following input formats will be recognized:

- *YYYY-MM-DD*
- *YYYY-MM-DD HH:MM*
- *YYYY-MM-DD HH:MM:SS*
- *YYYY-MM-DD HH:MM:SS.sss*
- *YYYY-MM-DDTHH:MM*
- *YYYY-MM-DDTHH:MM:SS*

- `YYYY-MM-DDTHH:MM:SS.sss`
- `HH:MM`
- `HH:MM:SS`
- `HH:MM:SS.sss`
- `now`
- `DDDDDD`
- `DDDDDD.dddddd`

In the case of the second, third, and fourth formats, there is a single literal space character between the date portion and the time portion. The fifth, sixth, and seventh formats have a literal T between the date and time portions. This format is specified by a number of ISO standards, including the standard format for XML timestamps. The last two formats are assumed to be a Julian Day or (with a modifier) a POSIX time value. These last two don't require a specific number of digits, and can be passed in as numeric values.

Internally, `strftime()` will always compute a full timestamp that contains both a date and time value. Any fields that are not specified by the input time string will assume default values. The default hour, minute, and second values are zero, or midnight, while the default date is 1 January 2000.

In addition to doing translations between formats and representations, the `strftime()` function can also be used to manipulate and modify time values before they are formatted and returned. Zero or more modifiers can be provided:

- `[+-]NNN day[s]`
- `[+-]NNN hour[s]`
- `[+-]NNN minute[s]`
- `[+-]NNN second[s]`
- `[+-]NNN.nnn second[s]`
- `[+-]NNN month[s]`
- `[+-]NNN year[s]`
- start of month
- start of year
- start of day
- weekday *N*
- unixepoch
- localtime
- utc

The first seven modifiers simply add or subtract the specified amount of time. This is done by translating the time and date into a segregated representation and then adding or subtracting the specified value. This can lead to invalid dates, however. For example, applying the modifier '+1 month' to the date '2010-01-31' would result in the date '2010-02-31', which does not exist. To avoid this problem, after each modifier is applied, the date and time values are normalized back to legitimate dates. For example, the hypothetical date '2010-02-31' would become '2010-03-03', since the unnormalized date was three days past the end of February.

The fact that the normalization is done after each modifier is applied means the order of the modifiers can be very important. Careful consideration should be given to how modifiers are applied, or you may encounter some unexpected results. For example, applying the modifier '+1 month' followed by '-1 month' to the date '2010-01-31', will result in the date '2010-02-03', which is three days off from the original value. This is because the first modifier gets normalized to '2010-03-03', which is then moved back to '2010-02-03'. If the modifiers are applied in the opposite order, '-1 month' will convert our starting date to '2009-12-31', and the '+1 month' modifier will then convert the date back to the original starting date of '2010-01-31'. In this instance we end up back at the original date, but that might not always be the case.

The three `start of...` modifiers shift the current date back in time to the specified point, while the `weekday` modifier will shift the date forward zero to six days, in order to find a date that falls on the specified day of the week. Acceptable `weekday` values are 0-6, with Sunday being 0.

The `unixepoch` modifier can only be used as an initial modifier to a numeric time value. In that case, the value is assumed to represent a POSIX time, rather than a Julian Day, and is translated appropriately. Although the `unixepoch` modifier must appear as the first modifier, additional modifiers can still be applied.

The last two modifiers are used to translate between UTC and local time representations. The modifier name describes the translation destination, so `localtime` assumes a UTC input and produces a local output. Conversely, the `utc` modifier assumes a local time input and produces a UTC output. SQLite is dependent on the local operating system (and its time zone and DST configuration) for these translations. As a result, these modifiers are subject to any errors and bugs that may be present in the time and date libraries of the host operating system.

## Convenience functions

In an effort to help standardized text formats, avoid errors, and provide a more convenient way to convert dates and times into their most common representations, SQLite has a number of convenience functions. Conceptually, these are wrapper functions around `strftime()` that output the date or time in a fixed format. All four of these functions take the same parameter set, which is essentially the same as the parameters used by `strftime()`, minus the initial format string.

`date( timestring, modifier, modifier... )`

Translates the time string, applies any modifiers, and outputs the date in the format YYYY-MM-DD. Equivalent to the format string '%Y-%m-%d'.

`time( timestring, modifier, modifier... )`

Translates the time string, applies any modifiers, and outputs the date in the format HH:MM:SS. Equivalent to the format string '%H:%M:%S'.

`datetime( timestring, modifier, modifier... )`

Translates the time string, applies any modifiers, and outputs the date in the format YYYY-MM-DD HH:MM:SS. Equivalent to the format string '%Y-%m-%d %H:%M:%S'.

`julianday( timestring, modifier, modifier... )`

Translates the time string, applies any modifiers, and outputs the Julian Day. Equivalent to the format string '%J'. This function differs slightly from the `strftime()` function, as `strftime()` will return a Julian Day as a text representation of a floating-point number, while this function will return an actual floating-point number.

All four of these functions recognize the same time string and modifier values that `strftime()` uses.

## Time literals

SQLite recognizes three literal expressions. When an expression that contains one of these literals is evaluated, the literal will take on the appropriate text representation of the current date or time in UTC.

### CURRENT\_TIME

Provides the current time in UTC. The format will be HH:MM:SS with an hour value between 00 and 23, inclusive. This is the same as the SQL expression `time( 'now' )`.

### CURRENT\_DATE

Provides the current date in UTC. The format will be YYYY-MM-DD. This is the same as the SQL expression `date( 'now' )`.

### CURRENT\_TIMESTAMP

Provides the current date and time in UTC. The format will be YYYY-MM-DD HH:MM:SS. There is a single space character between the date and time segments. This is the same as the SQL expression `datetime( 'now' )`. Note that the name of the SQL function is `datetime()`, while the literal is `_TIMESTAMP`.

Because these literals return the appropriate value in UTC, an expression such as `SELECT CURRENT_TIMESTAMP;` may not return the expected result. To get date and time in the local representation, you need to use an expression such as:

```
SELECT datetime( CURRENT_TIMESTAMP, 'localtime' );
```

In this case, the literal `CURRENT_TIMESTAMP` could also be replaced with `'now'`.

## Examples

In some ways, the simplicity of the date and time functions can mask their power. The following examples demonstrate how to accomplish basic tasks.

Here is an example of how to take a local timestamp and store it as a UTC Julian value:

```
julianday( input_value, 'utc' )
```

This type of expression might appear in an `INSERT` statement. To insert the current time, this could be simplified to the `'now'` value, which is always given in UTC:

```
julianday( 'now' )
```

If you want to display a Julian value out of the database, you'll want to convert the UTC Julian value to the local time zone and format it. This can be done like this:

```
datetime( jul_date, 'localtime' )
```

It might also be appropriate to put an expression like this into a view.

If you wanted to present the date in a format more comfortable for readers from the United States, you might do something like this:

```
strftime( '%m/%d/%Y', '2010-01-31', 'localtime' );
```

This will display the date as `01/31/2010`. The second parameter could also be a Julian value, or any other recognized date format.

To get the current POSIX time value (which is always in UTC):

```
strftime( '%s', 'now' )
```

Or to display the local date and time, given a POSIX time value:

```
datetime( time_value, 'unixepoch', 'localtime' )
```

Don't forget that the input value is usually a simple text value. The value can be built up by concatenating together individual values, if required. For example, the following will calculate a Julian value from individual year, month, and day values that are bound to the statement parameters. Just be sure to bind them as text values with the proper number of leading zeros:

```
julianday( :year || '-' || :month || '-' || :day )
```

As you can see, once you understand how to combine different input formats with the correct modifiers, moving back and forth between time representations is fairly easy. This makes it much simpler to store date and time values using native representations that are otherwise unintelligible to most people.

## ICU Internationalization Extension

SQLite provides full support for Unicode text values. Unicode provides a way to encode many different character representations, allowing a string of bytes to represent written characters, glyphs, and accents from a multitude of languages and writing systems.

What Unicode does *not* provide is any information or understanding of the sorting rules, capitalization rules, or equivalence rules and customs of a given language or location.

This is a problem for pattern matching, sorting, or anything that depends on comparing text values. For example, most text-sorting systems will ignore case differences between words. Some languages will also ignore certain accent marks, but often those rules depend on the specific accent mark and character. Occasionally, the rules and conventions used within a language change from location to location. By default, the only character system SQLite understands is 7-bit ASCII. Any character encoding of 128 or above will be treated as a binary value with no awareness of capitalization or equivalence conventions. While this is often sufficient for English, it is usually insufficient for other languages.

For more complete internationalization support, you'll need to build SQLite with the ICU extension enabled. The *International Components for Unicode* project is an open-source library that implements a vast number of language-related functions. These functions are customized for different locales. The SQLite ICU extension allows SQLite to utilize different aspects of the ICU library, allowing locale-aware sorts and comparisons, as well as locale-aware versions of `upper()` and `lower()`.

To use the ICU extension, you must first download and build the ICU library. The library source code, along with build instructions, can be downloaded from the project website at <http://www.icu-project.org/>. You must then build SQLite with the ICU extension enabled, and link it against the ICU library. To enable the ICU extension in an amalgamation build, define the `SQLITE_ENABLE_ICU` compiler directive.

You'll want to take a look at the original README document. It explains how to utilize the extension to create locale-specific collations and operators. You can find a copy of the README file in the full source distribution (in the `ext/icu` directory) or online at <http://www.sqlite.org/src/artifact?ci=trunk&filename=ext/icu/README.txt>.

The main disadvantage of the ICU library is size. In addition to the library itself, the locale information for all of the languages and locations adds up to a considerable bulk. This extra data may not be significant for a desktop system, but it may prove impractical on a handheld or embedded device.

Although the ICU extension can provide location-aware sorting and comparison capabilities, you still need to pick a specific locale to define those sorting and comparison rules. This is simple enough if you're only working with one language in one location, but it can be quite complex when languages are mixed. If you must deal with cross-locale sorts or other complex internationalization issues, it may be easier to pull that logic up into your application's code.

## Full-Text Search Module

SQLite includes a Full-Text Search (FTS) engine. The current version is known as FTS3. The FTS3 engine is designed to catalog and index large bodies of text. Once indexed, the FTS3 engine can quickly search for documents based off various types of keyword searches. Although the FTS3 source is now maintained by the SQLite team, parts of the engine were originally contributed by members of Google's engineering team.

The FTS3 engine is a virtual table module. Virtual tables are similar to views, in that they wrap a data source to make it look and act like a normal table. Views get their data from a `SELECT` statement, while virtual tables depend on user-defined C functions. All of the functions required to implement a virtual table are wrapped up in an extension known as a module. For more information on how SQLite modules and virtual tables work, see [Chapter 10](#).

Full-Text Search is an important and evolving technology, and is one of the areas that is targeted for improvements and enhancements as this book goes to press. Although this section gives a brief overview of the core FTS3 features, if you find yourself considering the FTS3 module, I would encourage you to review the full documentation on the SQLite website.

The FTS3 engine is included in all standard distributions of the SQLite source (including the amalgamation), but is turned off by default. To enable basic FTS functionality, define the `SQLITE_ENABLE_FTS3` compiler directive when building the SQLite library. To enable the more advanced matching syntax, also define `SQLITE_ENABLE_FTS3_PARENTHESIS`.

### Creating and Populating FTS Tables

Once SQLite has been compiled with the FTS3 engine enabled, you can create a document table with an SQL statement similar to this:

```
CREATE VIRTUAL TABLE table_name USING FTS3 ( col1,... );
```

In addition to providing a table name, you can define zero or more column names. The name of the column is the only information that will actually be used. Any type information or column constraints will be ignored. If no column names are given, FTS will automatically create one column with the name `content`.

FTS tables are often used to hold whole documents, in which case they only need one column. Other times, they are used to hold different categories of related information, and require multiple columns. For example, if you wanted to store email messages in an FTS table, it might make sense to create separate columns for the "SUBJECT:" line, "FROM:" line, "TO:" line, and message body. This would allow you to limit searches to a specific column (and the data it contains). The column specification for an FTS table is largely determined by how you want to search for the data. FTS also provides an optimized way to look for a search term across all of the indexed columns.

You can use the standard `INSERT`, `UPDATE`, and `DELETE` statements to manipulate data within an FTS table. Like traditional tables, FTS tables have a `ROWID` column that contains a unique integer for each entry in the table. This column can also be referred to using the alias `DOCID`. Unlike traditional tables, the `ROWID` of an FTS table is stable through a vacuum (`VACUUM` in [Appendix C](#)), so it can be reliably referenced through a foreign key. Additionally, FTS tables have an internal column with the same name as the table name. This column is used for special operations. You cannot insert or update data in this column.

Any virtual table, including FTS tables, can be deleted with the standard `DROP TABLE` command.

## Searching FTS Tables

FTS tables are designed so that any `SELECT` statement will work correctly. You can even search for specific text values or patterns directly with the `=` or `LIKE` operators. These will work, although they'll be somewhat slow, since standard operators will require a full table scan.

The real power of the FTS system comes from a custom `MATCH` operator. This operator is able to take advantage of the indexes built around the individual text values, allowing very fast searches over large bodies of text. Generally, searches are done using a query similar to:

```
SELECT * FROM fts_table WHERE fts_column MATCH search_term;
```

The search term used by the `MATCH` operator has very similar semantics to those used in a web search engine. Search terms are broken down and matched against words and terms found in the text values of the FTS table. Generally, the FTS `MATCH` operator is case-insensitive and will only match against whole words. For example, the search term `'data'` will match `'research data'`, but not `'database'`. The order of the search terms does not matter. The terms `'cat dog'` and `'dog cat'` will match the same set of rows.

By default, `MATCH` will only match records that contain every word or term found in the search term. If the extended syntax is enabled, more complex logic statements can also be used to define more complex search patterns.

Normally, the terms will only be matched against the specified column. However, every FTS table has a special hidden column that has the same name as the table itself. If this column is specified in the match expression, then all of the columns will be searched. This makes it easy to construct “find all” type searches.



## More Details

The FTS module is fairly advanced, and offers a large number of search options and index optimizations. If you plan on using the FTS engine in your application, I strongly suggest you spend some time reading the online documentation (<http://www.sqlite.org/fts3.html>). The official documentation is quite extensive and covers the more advanced search features in some detail, complete with examples.

In addition to explaining the different search patterns, the online documentation also covers index optimization and maintenance. While this level of detail isn't always required, it can be beneficial for applications that heavily depend on FTS. The documents also explain how to provide a custom tokenizer to adapt the FTS engine to specific applications.

For those that want to dig even deeper, later sections of the document explain some of the internal workings of the FTS index. Information is provided on the shadow tables used by the FTS engine, as well as the process used to generate the token index. This level of knowledge isn't required to use the FTS system, but it is extremely useful if you are looking to modify the code, or if you're just curious about what is going on under the hood.

## R\*Trees and Spatial Indexing Module

The R\*Tree module is a standard extension to SQLite that provides an index structure that is optimized for multi-dimensional ranged data. The R\*Tree name refers to the internal algorithm used to organize and query the stored data. For example, in a two-dimensional R\*Tree, the rows might contain rectangles, in the form of a minimum and maximum longitude value, along with a minimum and maximum latitude. Queries can be made to quickly find all of the rows that contain or overlap a specific geological location or area. Adding more dimensions, such as altitude, allows more complex and specific searches.

R\*Trees are not limited to just spacial information, but can be used with any type of numeric range data that includes pairs of minimum and maximum values. For example, an R\*Tree table might be used to index the start and stop times of events. The index could then quickly return all of the events that were active at a specific point or range of time.

The R\*Tree implementation included with SQLite can index up to five dimensions of data (five sets of min/max pairs). Tables consist of an integer primary key column, followed by one to five pairs of floating-point columns. This will result in a table with an odd number of 3 to 11 columns. Data values must always be given in pairs. If you wish to store a point, simply use the same value for both the minimum and maximum component.

Generally, R\*Trees act as detail tables for more traditional tables. A traditional table can store whatever data is required to define the object in question, including a key reference to the R\*Tree data. The R\*Tree table is used to hold just the dimensional data.

Multi-dimensional R\*Trees, especially those used to store bounding rectangles or bounding volumes, are often approximations of the records they are indexing. In these cases, R\*Trees are not always able to provide an exact result set, but are used to efficiently provide a first approximation. Essentially, the R\*Tree is used as an initial filter to quickly and efficiently screen out all but a small percentage of the total rows. A more specific (and often more expensive) filter expression can be applied to get the final result set. In most cases, the query optimizer understands how to best utilize the R\*Tree, so that it is applied before any other conditional expressions.

R\*Trees are quite powerful, but they serve a very specific need. Because of this, we won't be spending the time to cover all the details. If an R\*Tree index sounds like something your application can take advantage of, I encourage you to check out the online documentation (<http://www.sqlite.org/rtree.html>). This will provide a full description on how to create, populate, and utilize an R\*Tree index.

## Scripting Languages and Other Interfaces

Like most database products, SQLite has bindings that allow the functionality of the C APIs to be accessed from a number of different scripting languages and other environments. In many cases, these extensions try to follow a standardized database interface developed by the language community. In other cases, the driver or scripting extension attempts to faithfully represent the native SQLite API.

With the exception of the Tcl extension, all of these packages were developed by the SQLite user community. As such, they are *not* part of the core SQLite project, nor are they supported by the SQLite development team. If you're having issues installing or configuring one of these drivers, asking for support on the main SQLite user's mailing list may produce limited results. You may have more luck on a project mailing list or, failing that, a more general language-specific support forum.

As is common with this type of software, support and long-term maintenance can be somewhat hit-or-miss. At the time of publishing, most of the drivers listed here have a good history of keeping current and in sync with new releases of the SQLite library. However, before you build your whole project around a specific wrapper or extension, make sure the project is still active.

### Perl

The preferred Perl module is `DBD::SQLite`, and is available on CPAN (<http://www.cpan.org>). This package provides a standardized, DBI-compliant interface to SQLite, as well as a number of custom functions that provide support for SQLite specific features.

The DBI provides a standard interface for SQL command processing. The custom functions provide some additional coverage of the SQLite API, and provide the ability to define SQL functions, aggregates, and collations using Perl. While the custom functions do not provide full coverage of the SQLite API, most of the more common operations are included.

## PHP

As the PHP language has evolved, so have the SQLite access methods. PHP5 includes several different SQLite extensions that provide both vendor-specific interfaces, as well as drivers for the standardized PDO (PHP Data Objects) interface.

There are two vendor-specific extensions. The *sqlite* extension has been included and enabled by default since PHP 5.0, and provides support for the SQLite v2 library. The *sqlite3* extension has been included and enabled by default since PHP 5.3.0 and, as you might guess, provides an interface for the current SQLite 3 library. The *sqlite3* library provides a pretty basic class interface to the SQL command APIs. It also supports the creation of SQL functions and aggregates using PHP.

PHP 5.1 introduced the PDO interfaces. The PDO extension is the latest solution to the problem of providing unified database access mechanisms. PDO acts as a replacement for the PEAR-DB and MDB2 interfaces found in other versions of PHP. The *PDO\_SQLITE* extension provides a PDO driver for the current SQLite v3 library. In addition to supporting the standard PDO access methods, this driver also provides custom methods to create SQL functions and aggregates using PHP.

Given that there is very little functional difference between the SQLite 3 vendor-specific library and the PDO SQLite 3 library, I suggest that new development utilize the PDO driver.

## Python

There are two popular Python interfaces available. Each wrapper addresses a different set of needs and requirements. At the time of this writing, both modules were under active development.

The *PySQLite* module (<http://code.google.com/p/pysqlite/>) offers a standardized Python DB-API 2.0 compliant interface to the SQLite engine. PySQLite allows applications to develop against a relatively database-independent interface. This is very useful for systems that need to support more than one database. Using a standardized interface also allows rapid prototyping with SQLite, while leaving a migration path to larger, more complex database systems. As of Python 2.5, PySQLite has become part of the Python Standard Library.

The *APSW* module (*Another Python SQLite Wrapper*; <http://code.google.com/p/apsw/>) has a very different design goal. The APSW provides a very minimal abstraction layer

that is designed to mimic the native SQLite C API as much as possible. APSW makes no attempt to provide compatibility with any other database product, but provides very broad coverage of the SQLite library, including many of the low-level features. This allows very fine-grain control, including the ability to create user-defined SQL functions, aggregates, and collations in Python. APSW can even be used to write a virtual table implementation in Python.

Both modules have their strong points. Which module is right for your application depends on your needs. If your database needs are fairly straightforward and you want a standardized interface that allows future migration, then PySQLite is a better fit. If you don't care about other database engines, but need very detailed control over SQLite, then APSW is worth a look.

## Java

There are a number of interfaces available to the Java language. Some of these are wrappers around the native C API, while others conform to the standardized Java Database Compatibility (JDBC) API.

One of the older wrappers is *Java SQLite* (<http://www.ch-werner.de/javasqlite/>), which provides support for both SQLite 2 and SQLite 3. The core of this library uses Java Native Interface (JNI) to produce an interface based off the native C interface. The library also contains a JDBC interface. It is a good choice if you need direct access to the SQLite API.

A more modern JDBC-only driver is the *SQLiteJDBC* package (<http://www.xerial.org/trac/Xerial/wiki/SQLiteJDBC>). This is a rather nice distribution, as the JAR file contains both the Java classes, as well as native SQLite libraries for Windows, Mac OS X, and Intel-based Linux. This makes cross-platform distribution quite easy. The driver is also heavily utilized by Xerial, so it tends to be well maintained.

## Tcl

SQLite has a strong history with the Tcl language. In fact, what we now know as SQLite started life as a Tcl extension. Much of the testing and development tools for SQLite are written in Tcl. In addition to the native C API, the Tcl extension is the only API supported by the core SQLite team.

To enable the Tcl bindings, download the TEA (Tcl Extension Architecture) distribution of the SQLite source from the SQLite website (<http://www.sqlite.org/download.html>). This version of the code is essentially the amalgamation distribution with the Tcl bindings appended to the end. This will build into a Tcl extension that can then be imported into any Tcl environment. Documentation on the Tcl interface can be found at <http://www.sqlite.org/tclsqlite.html>.

## ODBC

The ODBC (Open Database Connectivity) specification provides a standardized database API for a wide variety of database products. Like many of the language-specific extensions, ODBC drivers act as a bridge between an ODBC library and a specific database API. Using ODBC allows developers to write to a single API, which can then use any number of connectors to speak to a wide variety of database products. Many generic database tools utilize ODBC to support a broad range of database systems.

The best known connector for SQLite is *SQLiteODBC* (<http://www.ch-werner.de/sqliteodbc/>). SQLiteODBC is tested with a number of ODBC libraries, ensuring it should work with most tools and applications that utilize ODBC support.

## .NET

There are a number of independent SQLite projects that use .NET technologies. Some of these are simple C# wrappers that do little more than provide an object context for the SQLite API. Other projects attempt to integrate SQLite into larger frameworks, such as ADO (ActiveX Data Objects).

One of the more established open source projects is the *System.Data.SQLite* (<http://sqlite.phxsoftware.com/>) package. This package provides broad ADO support, as well as LINQ support.

There are also commercial ADO and LINQ drivers available. See the SQLite wiki for more information.

## C++

Although the SQLite C API can be accessed directly by C++ applications, some people prefer a more object-oriented interface. If you would prefer to use an existing library, there are a number of wrappers available. You can check the SQLite website or do some web searches if you're interested.

Be warned that few of these libraries are well maintained. You might be better off just writing and maintaining your own wrapper classes. The SQLite API has a rather object-influenced design, with most functions performing some type of manipulation or action on a specific SQLite data structure. As a result, most C++ wrappers are somewhat thin, providing little more than syntactical translation. Maintaining a private wrapper is normally not a significant burden.

Just remember that the core SQLite library is C, not C++, and cannot be compiled with most C++ compilers. Even if you choose to wrap the SQLite API in a C++ class-based interface, you'll still need to compile the core SQLite library with a C compiler.

## Other Languages

In addition to those languages listed there, there are wrappers, libraries, and extensions for a great number of other languages and environments. The wiki section of the SQLite website has an extensive list of third-party drivers at <http://www.sqlite.org/cvstrac/wiki?p=SQLiteWrappers>. Many of the listed drivers are no longer actively maintained, so be sure to research the project websites before investing in a particular driver. Those that are known to be abandoned are marked as such, but it is difficult to keep this kind of information up to date.

## Mobile and Embedded Development

As the power and capacity of smartphones, mobile devices, and other embedded systems continue to increase, these devices are able to deal with larger and more complex data. Many mobile devices are centered around organizing, searching, and displaying large quantities of structured data. This might be something as simple as an address book, or something much more complex, like mapping and route applications.

In many cases, application requirements for data storage and management fit very well with the relational model provided by SQLite. SQLite is a fairly small and very resource-aware product, making it run well in restricted environments. The database-in-a-file model also makes it easy to copy or back up datastores easily and quickly. Given all these factors, it should come as no surprise that almost every major smartphone SDK supports SQLite out of the box, or allows it to be easily compiled for their platform.

## Memory

Most mobile devices have limited memory resources. Applications must be conscious of their memory usage, and often need to limit the resources that may be consumed. In most cases, the majority of SQLite memory usage comes from the page cache. By picking a sensible page size and cache size, the majority of memory use can be controlled. Remember that each open or attached database normally has its own, independent cache. The page size can be adjusted at database creation with the `PRAGMA page_size` command, while the cache size can be adjusted at any time with `PRAGMA cache_size`. See [page\\_size](#) and [cache\\_size](#) in [Appendix F](#) for more details.

Be aware that larger cache sizes are not always significantly better. Because some types of flash storage systems have no effective seek time, it is sometimes possible to utilize a relatively small page cache while still maintaining acceptable performance. The faster response time of the storage system reduces the cost of pulling pages into memory, lessening the impact of the cache. Just how fast the storage system can respond has a great deal to do with types of flash chips and how they are configured in the device, but depending on your system, you may find it acceptable to use a relatively small cache. This should help keep your memory footprint under control.

If you're working in an extremely constrained environment, you can preallocate buffers and make them available to SQLite through the `sqlite3_config()` interface. Different buffers can be assigned for the SQLite heap, scratch buffers, and page cache. If buffers are configured before the SQLite library is initialized, all memory allocations will come from these buffers. This allows a host application precise control over the memory resources SQLite may use.

Most other issues are fairly self-evident. For example, the use of in-memory databases is generally discouraged on memory-bound devices, unless the database is very small and the performance gains are significant. Similarly, be aware of queries that can generate large intermediate result sets, such as `ORDER BY` clauses. In some cases it may make more sense to pull some of the processing or business logic out of the database and into your application, where you have better control over resource utilization.

## Storage

Nearly all mobile devices use some type of solid-state storage media. The storage may be on-board, or it may be an expansion card, such as an SD (Secure Digital) card, or even an external thumb drive. Although these storage systems provide the same basic functionality as their “real computer” counterparts, these storage devices often have noticeably different operating characteristics from traditional mass-store devices.

If possible, try to match the SQLite page size to the native block size of the storage system. Matching the block sizes will allow the system to write database pages more quickly and more efficiently. You want the database page size to be the same size as one or more whole filesystem blocks. Pages that use partial blocks will be much slower. You don't want to make the page too large, however, or you'll be limiting your cache performance. Finding the right balance can take some experimentation.

Normally, SQLite depends heavily on filesystem locking to provide proper concurrency support. Unfortunately, this functionality can be limited on mobile and embedded platforms. To avoid problems, it is best to forego multiple database connections to the same database file, even from the same application. If multiple connections are required, make sure the operating system is providing proper locking, or use an alternate locking system. Also consider configuring database connections to acquire and hold any locks (use the `PRAGMA locking_mode` command; see [locking\\_mode](#) in [Appendix F](#)). While this makes access exclusive to one connection, it increases performance while still providing protection.

It may be tempting to turn off SQLite's synchronization and journaling mechanism, but you should consider any possible consequences of disabling these procedures. While there are often significant performance gains to be found in disabling synchronizations and journal files, there is also the significant danger of unrecoverable data corruption.

For starters, mobile devices run off batteries. As we all know, batteries have a tendency to go dead at very annoying times. Even if the operating system provides low-power warnings and automatic sleep modes, on many models it is all too easy to instantly dislodge the battery if the device is dropped or mishandled. Additionally, many devices utilize removable storage, which has a tendency to be removed and disappear at inconvenient times. In all cases, the main defense against a corrupt database is the storage synchronization and journaling procedure.

Storage failures and database corruption can be particularly devastating in a mobile or embedded environment. Because mobile platforms tend to be more closed to the user, it is often difficult for the end-user to back up and recover data from individual applications, even if they are disciplined enough to regularly back up their data. Finally, data entry is often slow and cumbersome on mobile devices, making the prospect of manual recovery a long and undesirable prospect. Mobile applications should be as forgiving and error tolerant as possible. In many cases, losing a customer's data will result in losing a customer.

## Other Resources

Beyond special memory handlers and storage considerations, most other concerns boil down to being aware of the limitations of your platform and keeping resource use under control. If you're preparing a custom SQLite build for your application, you should take some time to run through all the available compiler directives and see if there are any defaults you want to alter or any features you might want to disable (see [Appendix A](#)). Disabling unused features can reduce the code and memory footprints even further. Disabling some features also provides minor performance increases.

It is also a good idea to read through the available `PRAGMA` statements and see if there are any further configuration options to customize SQLite behavior for your specific environment. `PRAGMA` commands can also be used to dynamically adjust resource use. For example, it might be possible to temporarily boost the cache size for an I/O intensive operation if it is done at a time when you know more memory is available. The cache size could then be reduced, allowing the memory to be used elsewhere in the application.

## iPhone Support

When the iPhone and iPod touch were first released, Apple heavily advocated the use of SQLite. The SQLite library was provided as a system framework and was well documented, complete with code examples, in the SDK.

With the release of version 3.0, Apple has made their Core Data system available on the iPhone OS. Core Data has been available on the Macintosh platform for a number of years, and provides a high-level data abstraction framework that offers integrated



design tools and runtime support to address complex data management needs. Unlike SQLite, the Core Data model is not strictly relational in nature.

Now that the higher level library is available on their mobile platform, Apple is encouraging people to migrate to Core Data. Most of the SQLite documentation and code examples have been removed from the SDK, and the system-level framework is no longer available. However, because Core Data utilizes SQLite in its storage layer, there is still a standard SQLite system library available for use. It is also relatively easy to compile application-specific versions of the SQLite library. This is required if you want to take advantage of some of the more recent features, as the system version of SQLite is often several versions behind.

Core Data has some significant advantages. Apple provides development tools that allow a developer to quickly lay out their data requirements and relationships. This can reduce development time and save on code. The Core Data package is also well integrated into current Mac OS X systems, allowing data to move back and forth between the platforms quite easily.

For all the advantages that Core Data provides, there are still situations where it makes sense to use SQLite directly. The most obvious consideration is if your development needs extend beyond Apple platforms. Unlike Core Data, the SQLite library is available on nearly any platform, allowing data files to be moved and accessed almost anywhere on any platform. Core Data also uses a different storage and retrieval model than SQLite. If your application is particularly well suited to the Relational Model, there may be advantages to having direct SQL query access to the data storage layer. Using the SQLite library directly also eliminates a number of abstraction layers from the application design. While this may lead to more detailed code, it is also likely to result in better performance, especially with larger datasets.

Like many engineering choices, there are benefits and concerns with both approaches. Assuming the platform limitations aren't a concern, Core Data can provide a very rapid solution for moderately simple systems. On the other hand, SQLite allows better cross-platform compatibility (in both code and data), and allows direct manipulation of complex data models. If you're not dependent on the latest version of SQLite, you may even be able to reduce the size of your application by using the existing SQLite system library. Which set of factors has higher value to you is likely to be dependent on your platform requirements, and the complexity of your data model.

## Other Environments

A number of smartphone environments require application development to be done in Java or some similar language. These systems often provide no C compilers and limit the ability to deploy anything but byte-code. While most of these platforms provide custom wrappers to system SQLite libraries, these wrappers are often somewhat limited. Typically, the system libraries are several versions behind, and the Java wrappers are often limited to the essential core function calls.

While this may limit the ability to customize the SQLite build and use advanced features of the SQLite product, these libraries still provide full access to the SQL layer and all the functionality that comes with it, including constraints, triggers, and transactions. To get around some limitations (like the lack of user-defined functions), it may sometimes be necessary to pull some of the business logic up into the application. This is best done by designing an access layer into the application that centralizes all of the database functions. Centralizing allows the application code to consistently enforce any database design constraints, even when the database is unable to fully do so. It is also a good idea to include some type of verification function that can scan a database, identifying (and hopefully correcting) any problems.

## Additional Extensions

In addition to those interfaces and modules covered here, there are numerous other extensions and third-party packages available for SQLite. Some are simple but useful extensions, such as a complete set of mathematical functions. The best way to find these are through web searches, or by asking on the SQLite User's mailing list. You can also start by having a look at <http://sqlite.org/contrib/> for a list of some of the older code contributions.

In addition to database extensions, there are also several SQLite-specific tools and database managers available. In addition to the command-line shell, several GUI interfaces exist. One of the more popular is SQLite Manager, a Firefox extension available at <http://code.google.com/p/sqlite-manager/>.

A small number of commercial extensions for SQLite also exist. As already discussed, some of the database drivers require a commercial license. Hwaci, Inc., (the company responsible for developing SQLite) offers two commercial extensions. The *SQLite Encryption Extension* (SEE) encrypts database pages as they are written to disk, effectively encrypting any database. The *Compressed and Encrypted Read-Only Database* (CEROD) extension goes further by compressing database pages. The compression reduces the size of the database file, but also makes the database read-only. This extension can be useful for distributing licensed data archives or reference materials. For more information on these extensions, see <http://www.sqlite.org/support.html>.

---

# SQL Functions and Extensions

SQLite allows a developer to expand the SQL environment by creating custom SQL functions. Although these functions are used in SQL statements, the code to implement the function is written in C.

SQLite supports three kinds of custom functions. Simple *scalar functions* are the first type. These take some set of parameters and return a single value. An example would be the built-in function `abs()`, which takes a single numeric parameter and returns the absolute value of that number.

The second type of function is an *aggregate function*, or *aggregator*. These are SQL functions, such as `sum()` or `avg()`, that are used in conjunction with `GROUP BY` clauses to summarize or otherwise aggregate a series of values together into a final result.

The last type of custom function is a *collation*. Collations are used to define a custom sort orders for an index or an `ORDER BY` clause. Conceptually, collation functions are quite simple: they take two text values and return a greater than, less than, or equal status. In practice, collations can become quite complex, especially when dealing with natural language strings.

This chapter will also take a look at how to package up a set of custom features into an SQLite *extension*. Extensions are a standard way to package custom functions, aggregations, collations, virtual tables (see [Chapter 10](#)), or any other custom feature. Extensions are a handy and standardized way to bundle up sets of related functions or customizations into SQL function libraries.

Extensions can be statically linked into an application, or they can be built into *loadable extensions*. Loadable extensions act as “plug-ins” for the SQLite library. Loadable extensions are a particularly useful way to load your custom functions into `sqlite3`, providing the ability to test queries or debug problems in the same SQL environment that is found in your application.

The source code to the examples found in this chapter can be found in the book download. Downloading the source will make it much easier to build the examples and try them out. See “[Example Code Download](#)” on page [xvi](#) for more information on where to find the source code.

## Scalar Functions

The structure and purpose of SQL scalar functions are similar to C functions or traditional mathematical functions. The caller provides a series of function parameters and the function computes and returns a value. Sometimes these functions are purely functional (in the mathematical sense), in that they compute the result based purely off the parameters with no outside influences. In other cases, the functions are more procedural in nature, and are called to invoke specific side effects.

The body of a function can do pretty much anything you want, including calling out to other libraries. For example, you could write a function that allows SQLite to send email or query the status of a web server all through SQL functions. Your code can also interact with the database and run its own queries.

Although scalar functions can take multiple parameters, they can only return a single value, such as an integer or a string. Functions cannot return rows (a series of values), nor can they return a result set, with rows and columns.

Scalar functions can still be used to process sets of data, however. Consider this SQL statement:

```
SELECT format( name ) FROM employees;
```

In this query, the scalar function `format()` is applied to every row in the result set. This is done by calling the scalar function over and over for each row, as each row is computed. Even though the `format()` function is only referenced once in this SQL statement, when the query is executed, it can result in many different invocations of the function, allowing it to process each value from the name column.

## Registering Functions

To create a custom SQL function, you must bind an SQL function name to a C function pointer. The C function acts as a callback. Any time the SQL engine needs to invoke the named SQL function, the registered C function pointer is called. This provides a way for an SQL statement to call a C function you have written.

These functions allow you to create and bind an SQL function name to a C function pointer:

```
int sqlite3_create_function(  sqlite3 *db, const char *func_name,
                             int num_param, int text_rep, void *udp,
                             func_ptr, step_func, final_func )
int sqlite3_create_function16( sqlite3 *db, const void *func_name,
                              int num_param, int text_rep, void *udp,
                              func_ptr, step_func, final_func )
```

Creates a new SQL function within a database connection. The first parameter is the database connection. The second parameter is the name of the function as either a UTF-8 or UTF-16 encoded string. The third parameter is the number of expected parameters to the SQL function. If this value is negative, the number of expected parameters is variable or undefined. Fourth is the expected representation for text values passed into the function, and can be one of `SQLITE_UTF8`, `SQLITE_UTF16`, `SQLITE_UTF16BE`, `SQLITE_UTF16LE`, or `SQLITE_ANY`. This is followed by a user-data pointer.

The last three parameters are all function pointers. We will look at the specific prototypes for these function pointers later. To register and create a scalar function, only the first function pointer is used. The other two function pointers are used to register aggregate functions and should be set to `NULL` when defining a scalar function.

SQLite allows SQL function names to be overloaded based off both the number of parameters and the text representation. This allows multiple C functions to be associated with the same SQL function name. You can use this overloading capability to register different C implementations of the same SQL function. This might be useful to efficiently handle different text encodings, or to provide different behaviors, depending on the number of parameters.

You are not required to register multiple text encodings. When the SQLite library needs to make a function call, it will attempt to find a registered function with a matching text representation. If it cannot find an exact match, it will convert any text values and call one of the other available functions. The value `SQLITE_ANY` indicates that the function is willing to accept text values in any possible encoding.

You can update or redefine a function by simply reregistering it with a different function pointer. To delete a function, call `sqlite3_create_function_xxx()` with the same name, parameter count, and text representation, but pass in `NULL` for all of the function pointers. Unfortunately, there is no way to find out if a function name is registered or not, outside of keeping track yourself. That means there is no way to tell the difference between a create action and a redefine action.

It is permissible to create a new function at any time. There are limits on when you can change or delete a function, however. If the database connection has any prepared statements that are currently being executed (`sqlite3_step()` has been called at least

once, but `sqlite3_reset()` has not), you cannot redefine or delete a custom function, you can only create a new one. Any attempt to redefine or delete a function will return `SQLITE_BUSY`.

If there are no statements currently being executed, you may redefine or delete a custom function, but doing so invalidates all the currently prepared statements (just as any schema change does). If the statements were prepared with `sqlite3_prepare_v2()`, they will automatically reprepare themselves next time they're used. If they were prepared with an original version of `sqlite3_prepare()`, any use of the statement will return an `SQLITE_SCHEMA` error.

The actual C function you need to write looks like this:

```
void custom_scalar_function( sqlite3_context *ctx,  
                             int num_values, sqlite3_value **values )
```

This is the prototype of the C function used to implement a custom scalar SQL function. The first parameter is an `sqlite3_context` structure, which can be used to access the user-data pointer as well as set the function result. The second parameter is the number of parameter values present in the third parameter. The third parameter is an array of `sqlite3_value` pointers.

The second and third parameters (`int num_values, sqlite3_value **values`) work together in a very similar fashion to the traditional C main parameters (`int argc, char **argv`).

In a threaded application, it may be possible for different threads to call into your function at the same time. As such, user-defined functions should be thread-safe.

Most user-defined functions follow a pretty standard pattern. First, you'll want to examine the `sqlite3_value` parameters to verify their types and extract their values. You can also extract the user-data pointer passed into `sqlite3_create_function_xxx()`. Your code can then perform whatever calculation or procedure is required. Finally, you can set the return value of the function or return an error condition.

## Extracting Parameters

SQL function parameters are passed into your C function as an array of `sqlite3_value` structures. Each of these structures holds one parameter value.

To extract working C values from the `sqlite3_value` structures, you need to call one of the `sqlite3_value_xxx()` functions. These functions are extremely similar to the `sqlite3_column_xxx()` functions in use and design. The only major difference is that these functions take a single `sqlite3_value` pointer, rather than a prepared statement and a column index.

Like their column counterparts, the value functions will attempt to automatically convert the value into whatever datatype is requested. The conversion process and rules are the same as those used by the `sqlite3_column_xxx()` functions. See [Table 7-1](#) for more details.

```
const void* sqlite3_value_blob( sqlite3_value *value )
```

Extracts and returns a pointer to a BLOB.

```
double sqlite3_value_double( sqlite3_value *value )
```

Extracts and returns a double-precision floating point value.

```
int sqlite3_value_int( sqlite3_value *value )
```

Extracts and returns a 32-bit signed integer value. The returned value will be clipped (without warning) if the parameter value contains an integer value that cannot be represented with only 32 bits.

```
sqlite3_int64 sqlite3_value_int64( sqlite3_value *value )
```

Extracts and returns a 64-bit signed integer value.

```
const unsigned char* sqlite3_value_text( sqlite3_value *value )
```

Extracts and returns a UTF-8 encoded text value. The value will always be null-terminated. Note that the returned `char` pointer is unsigned and will likely require a cast. The pointer may also be NULL if a type conversion was required.

```
const void* sqlite3_value_text16( sqlite3_value *value )
```

```
const void* sqlite3_value_text16be( sqlite3_value *value )
```

```
const void* sqlite3_value_text16le( sqlite3_value *value )
```

Extracts and returns a UTF-16 encoded string. The first function returns a string in the native byte ordering of the machine. The other two functions will return a string that is always encoded in big-endian or little-endian. The value will always be null-terminated. The pointer may also be NULL if a type conversion was required.

There are also a number of helper functions to query the native datatype of a value, as well as query the size of any returned buffers.

```
int sqlite3_value_type( sqlite3_value *value )
```

Returns the native datatype of the value. The return value can be one of `SQLITE_BLOB`, `SQLITE_INTEGER`, `SQLITE_FLOAT`, `SQLITE_TEXT`, or `SQLITE_NULL`. This value can change or become invalid if a type conversion takes place.

```
int sqlite3_value_numeric_type( sqlite3_value *value )
```

This function attempts to convert a value into a numeric type (either `SQLITE_FLOAT` or `SQLITE_INTEGER`). If the conversion can be done without loss of data, then the conversion is made and the datatype of the new value is returned. If a conversion cannot be done, the value will not be converted and the original datatype of the value will be returned. This can be any value that is returned by `sqlite3_value_type()`.

The main difference between this function and simply calling `sqlite3_value_double()` or `sqlite3_value_int()`, is that the conversion will only take place if it is meaningful and will not result in lost data. For example, `sqlite3_value_double()` will convert a NULL into the value 0.0, while this function will not. Similarly, `sqlite3_value_int()` will convert the first part of the string '123xyz' into the integer 123, ignoring the trailing 'xyz'. This function will not, however, because no sense can be made of the trailing 'xyz' in a numeric context.

```
int sqlite3_value_bytes( sqlite3_value *value )
```

Returns the number of bytes in a BLOB or in a UTF-8 encoded string. If returning the size of a text value, the size will include the null-terminator.

```
int sqlite3_value_bytes16( sqlite3_value *value )
```

Returns the number of bytes in a UTF-16 encoded string, including the null-terminator.

As with the `sqlite3_column_xxx()` functions, any returned pointers can become invalid if another `sqlite3_value_xxx()` call is made against the same `sqlite3_value` structure. Similarly, data conversions can take place on text datatypes when calling `sqlite3_value_bytes()` or `sqlite3_value_bytes16()`. In general, you should follow the same rules and practices as you would with the `sqlite3_column_xxx()` functions. See “[Result Columns](#)” on page 127 for more details.

In addition to the SQL function parameters, the `sqlite3_context` parameter also carries useful information. These functions can be used to extract either the database connection or the user-data pointer that was used to create the function.

```
void* sqlite3_user_data( sqlite3_context *ctx )
```

Extracts the user-data pointer that was passed into `sqlite3_create_function_xxx()` when the function was registered. Be aware that this pointer is shared across all invocations of this function within this database connection.

```
sqlite3* sqlite3_context_db_handle( sqlite3_context *ctx )
```

Returns the database connection that was used to register this function.

The database connection returned by `sqlite3_context_db_handle()` can be used by the function to run queries or otherwise interact with the database.

## Returning Results and Errors

Once a function has extracted and verified its parameters, it can set about its work. When a result has been computed, that result needs to be passed back to the SQLite engine. This is done by using one of the `sqlite3_result_xxx()` functions. These functions set a result value in the function's `sqlite3_context` structure.

Setting a result value is the only way your function can communicate back to the SQLite engine about the success or failure of the function call. The C function itself has a `void` return type, so any result or error has to be passed back through the context structure. Normally, one of the `sqlite3_result_xxx()` functions is called just prior to



calling `return` within your C function, but it is permissible to set a new result multiple times throughout the function. Only the last result will be returned, however.

The `sqlite3_result_xxx()` functions are extremely similar to the `sqlite3_bind_xxx()` functions in use and design. The main difference is that these functions take an `sqlite3_context` structure, rather than a prepared statement and parameter index. A function can only return one result, so any call to an `sqlite3_result_xxx()` function will override the value set by a previous call.

```
void sqlite3_result_blob( sqlite3_context* ctx,
                        const void *data, int data_len, mem_callback )
```

Encodes a data buffer as a BLOB result.

```
void sqlite3_result_double( sqlite3_context *ctx, double data )
```

Encodes a 64-bit floating-point value as a result.

```
void sqlite3_result_int( sqlite3_context *ctx, int data )
```

Encodes a 32-bit signed integer as a result.

```
void sqlite3_result_int64( sqlite3_context *ctx, sqlite3_int64 data )
```

Encodes a 64-bit signed integer as a result.

```
void sqlite3_result_null( sqlite3_context *ctx )
```

Encodes an SQL NULL as a result.

```
void sqlite3_result_text( sqlite3_context *ctx,
                        const char *data, int data_len, mem_callback )
```

Encodes a UTF-8 encoded string as a result.

```
void sqlite3_result_text16(  sqlite3_context *ctx,
                            const void *data, int data_len, mem_callback )
```

```
void sqlite3_result_text16be( sqlite3_context *ctx,
                              const void *data, int data_len, mem_callback )
```

```
void sqlite3_result_text16le( sqlite3_context *ctx,
                              const void *data, int data_len, mem_callback )
```

Encodes a UTF-16 encoded string as a result. The first function is used for a string in the native byte format, while the last two functions are used for strings that are explicitly encoded as big-endian or little-endian, respectively.

```
void sqlite3_result_zeroblob( sqlite3_context *ctx, int length )
```

Encodes a BLOB as a result. The BLOB will contain the number of bytes specified, and each byte will all be set to zero (0x00).

```
void sqlite3_result_value( sqlite3_context *ctx, sqlite3_value *result_value )
```

Encodes an `sqlite3_value` as a result. A copy of the value is made, so there is no need to worry about keeping the `sqlite3_value` parameter stable between this call and when your function actually exits.

This function accepts both protected and unprotected value objects. You can pass one of the `sqlite3_value` parameters to this function if you wish to return one of the SQL function input parameters. You can also pass a value obtained from a call to `sqlite3_column_value()`.

Setting a BLOB or text value requires the same type of memory management as the equivalent `sqlite3_bind_xxx()` functions. The last parameter of these functions is a callback pointer that will properly free and release the given data buffer. You can pass a reference to `sqlite3_free()` directly (assuming the data buffers were allocated with `sqlite3_malloc()`), or you can write your own memory manager (or wrapper). You can also pass in one of the `SQLITE_TRANSIENT` or `SQLITE_STATIC` flags. See “[Binding Values](#)” on page 135 for specifics on how these flags can be used.

In addition to encoding specific datatypes, you can also return an error status. This can be used to indicate a usage problem (such as an incorrect number of parameters) or an environment problem, such as running out of memory. Returning an error code will result in SQLite aborting the current SQL statement and returning the error back to the application via the return code of `sqlite3_step()` or one of the convenience functions.

```
void sqlite3_result_error(  sqlite3_context *ctx,
                          const char *msg, int msg_size )
```

```
void sqlite3_result_error16( sqlite3_context *ctx,
                             const void *msg, int msg_size )
```

Sets the error code to `SQLITE_ERROR` and sets the error message to the provided UTF-8 or UTF-16 encoded string. An internal copy of the string is made, so the application can free or modify the string as soon as this function returns. The last parameter indicates the size of the message in bytes. If the string is null-terminated and the last parameter is negative, the string size is automatically computed.

```
void sqlite3_result_error_toobig( sqlite3_context *ctx )
```

Indicates the function could not process a text or BLOB value due to its size.

```
void sqlite3_result_error_nomem( sqlite3_context *ctx )
```

Indicates the function could not complete because it was unable to allocate required memory. This specialized function is designed to operate without allocating any additional memory. If you encounter a memory allocation error, simply call this function and have your function return.

```
void sqlite3_result_error_code( sqlite3_context *ctx, int code )
```

Sets a specific SQLite error code. Does not set or modify the error message.

It is possible to return both a custom error message and a specific error code. First, call `sqlite3_result_error()` (or `sqlite3_result_error16()`) to set the error message. This will also set the error code to `SQLITE_ERROR`. If you want a different error code, you can call `sqlite3_result_error_code()` to override the generic error code with something more specific, leaving the error message untouched. Just be aware that `sqlite3_result_error()` will always set the error code to `SQLITE_ERROR`, so you must set the error message before you set a specific error code.

## Example

Here is a simple example that exposes the SQLite C API function `sqlite3_limit()` to the SQL environment as the SQL function `sql_limit()`. This function is used to adjust various limits associated with the database connection, such as the maximum number of columns in a result set or the maximum size of a BLOB value.

Here's a quick introduction to the C function `sqlite3_limit()`, which can be used to adjust the soft limits of the SQLite environment:

```
int sqlite3_limit( sqlite3 *db, int limit_type, int limit_value )
```

For the given database connection, this sets the limit referenced by the second parameter to the value provided in the third parameter. The old limit is returned. If the new value is negative, the limit value will remain unchanged. This can be used to probe an existing limit. The soft limit cannot be raised above the hard limit, which is set at compile time.

For more specific details on `sqlite3_limit()`, see [sqlite3\\_limit\(\)](#) in [Appendix G](#). You don't need a full understanding of how this API call works to understand these examples.

Although the `sqlite3_limit()` function makes a good example, it might not be the kind of thing you'd want to expose to the SQL language in a real-world application. In practice, exposing this C API call to the SQL level brings up some security concerns. Anyone that can issue arbitrary SQL calls would have the capability of altering the SQLite soft limits. This could be used for some types of denial-of-service attacks by raising or lowering the limits to their extremes.

### sql\_set\_limit

In order to call the `sqlite3_limit()` function, we need to determine the `limit_type` and `value` parameters. This will require an SQL function that takes two parameters. The first parameter will be the limit type, expressed as a text constant. The second parameter will be the new limit. The SQL function can be called like this to set a new expression-depth limit:

```
SELECT sql_limit( 'EXPR_DEPTH', 400 );
```

The C function that implements the SQL function `sql_limit()` has four main parts. The first task is to verify that the first SQL function parameter (passed in as `values[0]`) is a text value. If it is, the function extracts the text to the `str` pointer:

```
static void sql_set_limit( sqlite3_context *ctx, int
                          num_values, sqlite3_value **values )
{
    sqlite3      *db = sqlite3_context_db_handle( ctx );
    const char  *str = NULL;
    int         limit = -1, val = -1, result = -1;
```

```

/* verify the first param is a string and extract pointer */
if ( sqlite3_value_type( values[0] ) == SQLITE_TEXT ) {
    str = (const char*) sqlite3_value_text( values[0] );
} else {
    sqlite3_result_error( ctx, "sql_limit(): wrong parameter type", -1 );
    return;
}

```

Next, the function verifies that the second SQL parameter (`values[1]`) is an integer value, and extracts it into the `val` variable:

```

/* verify the second parameter is an integer and extract value */
if ( sqlite3_value_type( values[1] ) == SQLITE_INTEGER ) {
    val = sqlite3_value_int( values[1] );
} else {
    sqlite3_result_error( ctx, "sql_limit(): wrong parameter type", -1 );
    return;
}

```

Although our SQL function uses a text value to indicate which limit we would like to modify, the C function `sqlite3_limit()` requires a predefined integer value. We need to decode the `str` text value into an integer limit value. I'll show the code to `decode_limit_str()` in just a bit:

```

/* translate string into integer limit */
limit = decode_limit_str( str );
if ( limit == -1 ) {
    sqlite3_result_error( ctx, "sql_limit(): unknown limit type", -1 );
    return;
}

```

After verifying our two SQL function parameters, extracting their values, and translating the text limit indicator into a proper integer value, we finally call `sqlite3_limit()`. The result is set as the result value of the SQL function and the function returns:

```

/* call sqlite3_limit(), return result */
result = sqlite3_limit( db, limit, val );
sqlite3_result_int( ctx, result );
return;
}

```

The `decode_limit_str()` function is very simple, and simply looks for a predefined set of text values:

```

int decode_limit_str( const char *str )
{
    if ( str == NULL ) return -1;
    if ( !strcmp( str, "LENGTH" ) ) return SQLITE_LIMIT_LENGTH;
    if ( !strcmp( str, "SQL_LENGTH" ) ) return SQLITE_LIMIT_SQL_LENGTH;
    if ( !strcmp( str, "COLUMN" ) ) return SQLITE_LIMIT_COLUMN;
    if ( !strcmp( str, "EXPR_DEPTH" ) ) return SQLITE_LIMIT_EXPR_DEPTH;
    if ( !strcmp( str, "COMPOUND_SELECT" ) ) return SQLITE_LIMIT_COMPOUND_SELECT;
    if ( !strcmp( str, "VDBE_OP" ) ) return SQLITE_LIMIT_VDBE_OP;
    if ( !strcmp( str, "FUNCTION_ARG" ) ) return SQLITE_LIMIT_FUNCTION_ARG;
    if ( !strcmp( str, "ATTACHED" ) ) return SQLITE_LIMIT_ATTACHED;
    if ( !strcmp( str, "LIKE_LENGTH" ) ) return SQLITE_LIMIT_LIKE_PATTERN_LENGTH;
}

```

```

    if ( !strcmp( str, "VARIABLE_NUMBER" ) ) return SQLITE_LIMIT_VARIABLE_NUMBER;
    if ( !strcmp( str, "TRIGGER_DEPTH" ) ) return SQLITE_LIMIT_TRIGGER_DEPTH;
    return -1;
}

```

With these two functions in place, we can create the `sql_limit()` SQL function by registering the `sql_set_limit()` C function pointer.

```

sqlite3_create_function( db, "sql_limit", 2, SQLITE_UTF8,
                        NULL, sql_set_limit, NULL, NULL );

```

The parameters for this function include the database connection (`db`), the name of the SQL function (`sql_limit`), the required number of parameters (2), the expected text encoding (UTF-8), the user-data pointer (NULL), and finally the C function pointer that implements this function (`sql_set_limit`). The last two parameters are only used when creating aggregate functions, and are set to NULL.

Once the SQL function has been created, we can now manipulate the limits of our SQLite environment by issuing SQL commands. Here are some examples of what the `sql_limit()` SQL function might look like if we integrated it into the `sqlite3` tool (we'll see how to do this using a loadable extension later in the chapter).

First, we can look up the current `COLUMN` limit by passing a new limit value of -1:

```

sqlite> SELECT sql_limit( 'COLUMN', -1 );
2000

```

We verify the function works correctly by setting the maximum column limit to two, and then generating a result with three columns. The previous limit value is returned when we set the new value:

```

sqlite> SELECT sql_limit( 'COLUMN', 2 );
2000
sqlite> SELECT 1, 2, 3;
Error: too many columns in result set

```

We see from the error that the soft limit is correctly set, meaning our function is working.

One thing you might be wondering about is parameter value count. Although the `sql_set_limit()` function carefully checks the types of the parameters, it doesn't actually verify that `num_values` is equal to two. In this case, it doesn't have to, since it was registered with `sqlite3_create_function()` with a required parameter count of two. SQLite will not even call our `sql_set_limit()` function unless we have exactly two parameters:

```

sqlite> SELECT sql_limit( 'COLUMN', 2000, 'extra' );
Error: wrong number of arguments to function sql_limit()

```

SQLite sees the wrong number of parameters and generates an error for us. This means that as long as a function is registered correctly, SQLite will do some of our value checking for us.

## sql\_get\_limit

While having a fixed parameter count simplifies the verification code, it might be useful to provide a single-parameter version that can be used to look up the current value. This can be done a few different ways. First, we can define a second C function called `sql_get_limit()`. This function would be the same as `sql_set_limit()`, but with the second block of code removed:

```
/* remove this block of code from a copy of */
/* sql_set_limit() to produce sql_get_limit() */
if ( sqlite3_value_type( values[1] ) == SQLITE_INTEGER ) {
    val = sqlite3_value_int( values[1] );
} else {
    sqlite3_result_error( ctx, "sql_limit(): wrong parameter type", -1 );
    return;
}
```

With this code removed, the function will never decode the second SQL function parameter. Since `val` is initialized to `-1`, this effectively makes every call a query call. We register each of these functions separately:

```
sqlite3_create_function( db, "sql_limit", 1,
    SQLITE_UTF8, NULL, sql_get_limit, NULL, NULL );
sqlite3_create_function( db, "sql_limit", 2,
    SQLITE_UTF8, NULL, sql_set_limit, NULL, NULL );
```

This dual registration overloads the SQL function name `sql_limit()`. Overloading is allowed because the two calls to `sqlite3_create_function()` have a different number of required parameters. If the SQL function `sql_limit()` is called with one parameter, then the C function `sql_get_limit()` is called. If two parameters are provided to the SQL function, then the C function `sql_set_limit()` is called.

## sql\_getset\_limit

Although the two C functions `sql_get_limit()` and `sql_set_limit()` provide the correct functionality, the majority of their code is the same. Rather than having two functions, it might be simpler to combine these two functions into one function that can deal with either one or two parameters, and is capable of both getting or setting a limit value.

This combine `sql_getset_limit()` function can be created by taking the original `sql_set_limit()` function and modifying the second section. Rather than eliminating it, as we did to create `sql_get_limit()`, we'll simply wrap it in an `if` statement, so the second section (which extracts the second SQL function parameter) is only run if we have two parameters:

```
/* verify the second parameter is an integer and extract value */
if ( num_values == 2 ) {
    if ( sqlite3_value_type( values[1] ) == SQLITE_INTEGER ) {
        val = sqlite3_value_int( values[1] );
    }
}
```

```

    } else {
        sqlite3_result_error( ctx, "sql_limit(): wrong parameter type", -1 );
        return;
    }
}

```

We register the same `sql_getset_limit()` C function under both parameter counts:

```

sqlite3_create_function( db, "sql_limit", 1,
    SQLITE_UTF8, NULL, sql_getset_limit, NULL, NULL );
sqlite3_create_function( db, "sql_limit", 2,
    SQLITE_UTF8, NULL, sql_getset_limit, NULL, NULL );

```

For this specific task, this is likely the best choice. SQLite will verify the SQL function `sql_limit()` has exactly one or two parameters before calling our C function, which can easily deal with either one of those two cases.

### **sql\_getset\_var\_limit**

If for some reason you don't like the idea of registering the same function twice, we could also have SQLite ignore the parameter count and call our function no matter what. This leaves verification of a valid parameter count up to us. To do that, we'd start with the `sql_getset_limit()` function and change it to `sql_getset_var_limit()`, by adding this block at the top of the function:

```

    if ( ( num_values < 1 ) || ( num_values > 2 ) ) {
        sqlite3_result_error( ctx, "sql_limit(): bad parameter count", -1 );
        return;
    }

```

We register just one version. By passing a required parameter count of `-1`, we're telling the SQLite engine that we're willing to accept any number of parameters:

```

sqlite3_create_function( db, "sql_limit", -1, SQLITE_UTF8,
    NULL, sql_getset_var_limit, NULL, NULL );

```

Although this works, the `sql_getset_limit()` version is still my preferred version. The registration makes it clear which versions of the function are considered valid, and the function code is reasonably clear and compact.

Completely free-form parameter counts are usually used by items like the built-in function `coalesce()`. The `coalesce()` function will take any number of parameters (greater than one) and return the first non-NULL value in the list. Since you might pass anywhere from two to a dozen or more parameters, it is impractical to register each possible configuration, and is better to just allow the function to do its own parameter management.

On the other hand, something like `sql_getset_limit()` can really only accept two configurations: one parameter or two. In that case, I find it easier to explicitly register both parameter counts and allow SQLite to do my parameter verification for me.

# Aggregate Functions

Aggregate functions are used to collapse values from a grouping of rows into a single result value. This can be done with a whole table, as is common with the aggregate function `count(*)`, or it can be done with groupings of rows from a `GROUP BY` clause, as is common with something like `avg()` or `sum()`. Aggregate functions are used to summarize, or aggregate, all of the individual row values into some single representative value.

## Defining Aggregates

SQL aggregate functions are created using the same `sqlite3_create_function_xxx()` function that is used to create scalar functions (See “[Scalar Functions](#)” on page 182). When defining a scalar function, you pass in a C function pointer in the sixth parameter and set the seventh and eighth parameter to `NULL`. When defining an aggregate function, the sixth parameter is set to `NULL` (the scalar function pointer) and the seventh and eighth parameters are used to pass in two C function pointers.

The first C function is a “step” function. It is called once for each row in an aggregate group. It acts similarly to an scalar function, except that it does not return a result (it may return an error, however).

The second C function is a “finalize” function. Once all the SQL rows have been stepped over, the finalize function is called to compute and set the final result. The finalize function doesn’t take any SQL parameters, but it is responsible for setting the result value.

The two C functions work together to implement the SQL aggregate function. Consider the built-in `avg()` aggregate, which computes the numeric average of all the rows in a column. Each call to the step function extracts an SQL value for that row and updates both a running total and a row count. The finalize function divides the total by the row count and sets the result value of the aggregate function.

The C functions used to implement an aggregate are defined like this:

```
void user_aggregate_step( sqlite3_context *ctx,  
                          int num_values, sqlite3_value **values )
```

The prototype of a user-defined aggregate step function. This function is called once for each row of an aggregate calculation. The prototype is the same as a scalar function and all of the parameters have similar meaning. The step function should not set a result value with `sqlite3_result_xxx()`, but it may set an error.

```
void user_aggregate_finalize( sqlite3_context *ctx )
```

The prototype of a user-defined aggregate finalize function. This function is called once, at the end of an aggregation, to make the final calculation and set the result. This function should set a result value or error condition.



Most of the rules about SQL function overloading that apply to scalar functions also apply to aggregate functions. More than one set of C functions can be registered under the same SQL function name if different parameter counts or text encodings are used. This is less commonly used with aggregates, however, as most aggregate functions are numeric-based and the majority of aggregates take only one parameter.

It is also possible to register both scalar and aggregate functions under the same name, as long as the parameter counts are different. For example, the built-in `min()` and `max()` SQL functions are available as both scalar functions (with two parameters) and aggregate functions (with one parameter).

Step and finalize functions can be mixed and matched—they don't always need to be unique pairs. For example, the built-in `sum()` and `avg()` aggregates both use the same step function, since both aggregates need to compute a running total. The only difference between these aggregates is the finalize function. The finalize function for `sum()` simply returns the grand total, while the finalize function for `avg()` first divides the total by the row count.

## Aggregate Context

Aggregate functions typically need to carry around a lot of state. For example, the built-in `avg()` aggregate needs to keep track of the running total, as well as the number of rows processed. Each call to the step function, as well as the finalize function, needs access to some shared block of memory that holds all the state values.

Although aggregate functions can call `sqlite3_user_data()` or `sqlite3_context_db_handle()`, you can't use the user-data pointer to store aggregate state data. The user-data pointer is shared by all instances of a given aggregate function. If more than one instance of the aggregate function is active at the same time (for example, an SQL query that averages more than one column), each instance of the aggregate needs a private copy of the aggregate state data, or the different aggregate calculations will get intermixed.

Thankfully, there is an easy solution. Because almost every aggregate function requires some kind of state data, SQLite allows you to attach a data-block to each specific aggregate instance.

```
void* sqlite3_aggregate_context( sqlite3_context *ctx, int bytes )
```

This function can be called inside an aggregate step function or finalize function. The first parameter is the `sqlite3_context` structure passed into the step or finalize function. The second parameter represents a number of bytes.

The first time this function is called within a specific aggregate instance, the function will allocate an appropriately sized block of memory, zero it out, and attach it to the aggregate context before returning a pointer. This function will return the same block of memory in subsequent invocations of the step and finalize functions. The memory block is automatically deallocated when the aggregate goes out of scope.

Using this API call, you can have the SQLite engine automatically allocate and release your aggregate state data on a per-instance basis. This allows multiple instances of your aggregate function to be active simultaneously without any extra work on your part.

Typically, one of the first things a step or finalize function will do is call `sqlite3_aggregate_context()`. For example, consider this oversimplified version of sum:

```
void simple_sum_step( sqlite3_context *ctx, int num_values, sqlite3_value **values )
{
    double *total = (double*)sqlite3_aggregate_context( ctx, sizeof( double ) );
    *total += sqlite3_value_double( values[0] );
}

void simple_sum_final( sqlite3_context *ctx )
{
    double *total = (double*)sqlite3_aggregate_context( ctx, sizeof( double ) );
    sqlite3_result_double( ctx, *total );
}

/* ...inside an initialization function... */
sqlite3_create_function( db, "simple_sum", 1, SQLITE_UTF8, NULL,
    NULL, simple_sum_step, simple_sum_final );
```

In this case, we're only allocating enough memory to hold a double-precision floating-point value. Most aggregate functions will allocate a C struct with whatever fields are required to compute the aggregate, but everything works the same way. The first time `simple_sum_step()` is called, the call to `sqlite3_aggregate_context()` will allocate enough memory to hold a double and zero it out. Subsequent calls to `simple_sum_step()` that are part of the same aggregation calculation (have the same `sqlite3_context`) will have the same block of memory returned, as will `simple_sum_final()`.

Because `sqlite3_aggregate_context()` may need to allocate memory, it is also a good idea to make sure the returned value is not NULL. The above code, in both the step and finalize functions, should really look something like this:

```
double *total = (double*)sqlite3_aggregate_context( ctx, sizeof( double ) );
if ( total == NULL ) {
    sqlite3_result_error_nomem( ctx );
    return;
}
```

The only caution with `sqlite3_aggregate_context()` is in properly dealing with data structure initialization. Because the context data structure is silently allocated and zeroed out on the first call, there is no obvious way to tell the difference between a newly allocated structure, and one that was allocated in a previous call to your step function.

If the default all-zero state of a newly allocated context is not appropriate, and you need to somehow initialize the aggregate context, you'll need to include some type of initialization flag. For example:

```

typedef struct agg_state_s {
    int    init_flag;
    /* other fields used by aggregate... */
} agg_state;

```

The aggregate functions can use this flag to determine if it needs to initialize the aggregate context data or not:

```

agg_state *st = (agg_state*)sqlite3_aggregate_context( ctx, sizeof( agg_state ) );
/* ...return nonmem error if st == NULL... */
if ( st->init_flag == 0 ) {
    st->init_flag = 1;
    /* ...initialize the rest of agg_state... */
}

```

Since the structure is zeroed out when it is first allocated, your initialization flag will be zero on the very first call. As long as you set the flag to something else when you initialize the rest of the data structure, you'll always know if you're dealing with a new allocation that needs to be initialized or an existing allocation that has already been initialized.

Be sure to check the initialization flag in both the step function and the finalize function. There are cases when the finalize function may be called without first calling the step function, and the finalize function needs to properly deal with those cases.

## Example

As a more in-depth example, let's look at a *weighted average* aggregate. Although most aggregates take only one parameter, our `wtavg()` aggregate will take two. The first parameter will be whatever numeric value we're trying to average, while the second, optional parameter will be a weighting for this row. If a row has a weight of two, its value will be considered to be twice as important as a row with a weighting of only one. A weighted average is taken by summing the product of the values and weights, and dividing by the sum of the weights.

To put things in SQL terms, if our `wtavg()` function is used like this:

```
SELECT wtavg( data, weight ) FROM ...
```

It should produce results that are similar to this:

```
SELECT ( sum( data * weight ) / sum( weight ) ) FROM ...
```

The main difference is that our `wtavg()` function should be a bit more intelligent about handling invalid weight values (such as a NULL) and assign them a weight value of 1.0.

To keep track of the total data values and the total weight values, we need to define an aggregate context data structure. This will hold the state data for our aggregate. The only place this structure is referenced is the two aggregate functions, so there is no need to put it in a separate header file. It can be defined in the code right along with the two functions:

```

typedef struct wt_avg_state_s {
    double total_data; /* sum of (data * weight) values */
    double total_wt; /* sum of weight values */
} wt_avg_state;

```

Since the default initialization state of zero is exactly what we want, we don't need a separate initialization flag within the data structure.

In this example, I've made the second aggregate function parameter (the weight value) optional. If only one parameter is provided, all the weights are assumed to be one, resulting in a traditional average. This will still be different than the built-in `avg()` function, however. SQLite's built-in `avg()` function follows the SQL standard in regard to typing and NULL handling, which might not be what you first assume. (See [avg\(\)](#) in [Appendix E](#) for more details). Our `wtavg()` is a bit simpler. In addition to always returning a double (even if the result could be expressed as an integer), it simply ignores any values that can't easily be translated into a number.

First, the step function. This processes each row, adding up the value-weight products, as well as the total weight value:

```

void wt_avg_step( sqlite3_context *ctx, int num_values, sqlite3_value **values )
{
    double row_wt = 1.0;
    int type;
    wt_avg_state *st = (wt_avg_state*)sqlite3_aggregate_context( ctx,
                                                                sizeof( wt_avg_state ) );

    if ( st == NULL ) {
        sqlite3_result_error_nomem( ctx );
        return;
    }

    /* Extract weight, if we have a weight and it looks like a number */
    if ( num_values == 2 ) {
        type = sqlite3_value_numeric_type( values[1] );
        if ( ( type == SQLITE_FLOAT ) || ( type == SQLITE_INTEGER ) ) {
            row_wt = sqlite3_value_double( values[1] );
        }
    }

    /* Extract data, if we were given something that looks like a number. */
    type = sqlite3_value_numeric_type( values[0] );
    if ( ( type == SQLITE_FLOAT ) || ( type == SQLITE_INTEGER ) ) {
        st->total_data += row_wt * sqlite3_value_double( values[0] );
        st->total_wt += row_wt;
    }
}

```

Our step function uses `sqlite3_value_numeric_type()` to try to convert the parameter values into a numeric type without loss. If the conversion is possible, we always convert the values to a double-precision floating-point, just to keep things simple. This approach means the function will work properly with text representations of numbers (such as the string '153'), but will ignore other datatypes and other strings.

In this case, the function does not report an error, it just ignores the value. If the weight cannot be converted, it is assumed to be one. If the data value cannot be converted, the row is skipped.

Once we have our totals, we need to compute the final answer and return the result. This is done in the finalize function, which is pretty simple. The main thing we need to worry about is the possibility of dividing by zero:

```
void wt_avg_final( sqlite3_context *ctx )
{
    double      result = 0.0;
    wt_avg_state *st = (wt_avg_state*)sqlite3_aggregate_context( ctx,
                                                                sizeof( wt_avg_state ) );

    if ( st == NULL ) {
        sqlite3_result_error_nomem( ctx );
        return;
    }

    if ( st->total_wt != 0.0 ) {
        result = st->total_data / st->total_wt;
    }
    sqlite3_result_double( ctx, result );
}
```

To use our aggregate, our application code needs to register these two functions with a database connection using `sqlite3_create_function()`. Since the `wtavg()` aggregate is designed to take either one or two parameters, we'll register it twice:

```
sqlite3_create_function( db, "wtavg", 1, SQLITE_UTF8, NULL,
                        NULL, wt_avg_step, wt_avg_final );
sqlite3_create_function( db, "wtavg", 2, SQLITE_UTF8, NULL,
                        NULL, wt_avg_step, wt_avg_final );
```

Here are some example queries, as seen from the `sqlite3` command shell. This assumes we've integrated our custom aggregate into the `sqlite3` code (an example of the different ways to do this is given later in the chapter):

```
sqlite> SELECT class, value, weight FROM t;
```

class	value	weight
1	3.4	1.0
1	6.4	2.3
1	4.3	0.9
2	3.4	1.4
3	2.7	1.1
3	2.5	1.1

First, we can try things with only one parameter. This will use the default 1.0 weight for each row, resulting in a traditional average calculation:

```
sqlite> SELECT class, wtavg( value ) AS wtavg, avg( value ) AS avg
...> FROM t GROUP BY 1;
```

class	wtavg	avg
1	4.7	4.7
2	3.4	3.4
3	2.6	2.6

And finally, here is an example of the full weighted-average calculation:

```
sqlite> SELECT class, wtavg( value, weight ) AS wtavg, avg( value ) AS avg
...> FROM t GROUP BY 1;
```

class	wtavg	avg
1	5.23571428571428	4.7
2	3.4	3.4
3	2.6	2.6

In the case of `class=1`, we see a clear difference, where the heavily weighted 6.4 draws the average higher. For `class=2`, there is only one value, so the weighted and unweighted averages are the same (the value itself). In the case of `class=3`, the weights are the same for all values, so again, the average is the same as an unweighted average.

## Collation Functions

Collations are used to sort text values. They can be used with `ORDER BY` or `GROUP BY` clauses, or for defining indexes. You can also assign a collation to a table column, so that any index or ordering operation applied to that column will automatically use a specific collation. Above everything else, SQLite will always sort by datatype. NULLs will always come first, followed by a mix of integer and floating-point numeric values in their natural sort order. After the numbers come text values, followed by BLOBs.

Most types have a clearly defined sort order. NULL types have no values, so they cannot be sorted. Numeric types use their natural numeric ordering, and BLOBs are always sorted using binary comparisons. Where things get interesting is when it comes to text values.

The default collation is known as the `BINARY` collation. The `BINARY` collation sorts individual bytes using a simple numeric comparison of the underlying character encoding. The `BINARY` collation is also used for BLOBs.

In addition to the default `BINARY` collation, SQLite includes a built-in `NOCASE` and `RTRIM` collation that can be used with text values. The `NOCASE` collation ignores character case for the purposes of sorting 7-bit ASCII, and would consider the expression `'A' == 'a'` to be true. It does not, however, consider `'Ä' == 'ä'` to be true, nor does it consider `'Ä' == 'A'` to be true, as the representations of these characters are outside of the ASCII standard. The `RTRIM` collation (right-trim) is similar to the default `BINARY` collation, only it ignores trailing whitespace (that is, whitespace on the right side of the value).

While these built-in collations offer some basic options, there are times when complex sort ordering is required. This is especially true when you get into Unicode representations of languages that cannot be represented with a simple 7-bit ASCII encoding. You may also need a specialized sorting function that sorts by whole words or groups of characters if you're storing something other than natural language text. For example, if you were storing gene sequences as text data, you might require a custom sorting function for that data.

User-defined collation functions allow the developer to define a new collation by registering a comparison function. Once registered, this function is used to compare strings as part of any sorting process. By defining the basic comparison operator, you essentially define the behavior of the whole collation.

## Registering a Collation

To define a custom collation, an application needs to register a comparison function under a collation name. Anytime the database engine needs to sort something under that collation, it uses the comparison function to define the required ordering. You will need to reregister the collation with each database connection that requires it.

There are three API calls that can be used to register a collation comparison function:

```
int sqlite3_create_collation(  sqlite3 *db, const char *name,
                             int text_rep, void *udp, comp_func )
int sqlite3_create_collation16( sqlite3 *db, const void *name,
                                int text_rep, void *udp, comp_func )
```

Registers a collation comparison function with a database connection. The first parameter is the database connection. The second parameter is the name of the custom collation encoded as a UTF-8 or UTF-16 string. The third parameter is the string encoding the comparison function expects, and can be one of `SQLITE_UTF8`, `SQLITE_UTF16`, `SQLITE_UTF16BE`, `SQLITE_UTF16LE`, or `SQLITE_UTF16_ALIGNED` (native UTF-16 that is 16-bit memory aligned). The fourth parameter is a generic user-data pointer that is passed to your comparison function. The last parameter is a function pointer to your comparison function (the prototype of this function is given below).

You can unregister a collation by passing a `NULL` function pointer in under the same name and text encoding as it was originally registered.

```
int sqlite3_create_collation_v2( sqlite3 *db, const char *name,
                                int text_rep, void *udp, comp_func,
                                dest_func )
```

This function is the same as `sqlite3_create_collation()`, with one additional parameter. The additional sixth parameter is an optional function pointer referencing a clean-up function that is called when the collation is destroyed (the prototype of this function is given below). This allows the collation to release any resources associated with the collation (such as the user-data pointer). A `NULL` function pointer can be passed in if no destroy function is required.

A collation is destroyed when the database connection is closed, when a replacement collation is registered, or when the collation name is cleared by binding a NULL comparison function pointer.

The collation name is case-insensitive. SQLite allows multiple C sorting functions to be registered under the same name, so long as they take different text representations. If more than one comparison function is available under the same name, SQLite will pick the one that requires the least amount of conversion. If you do register more than one function under the same name, their logical sorting behavior should be the same.

The format of the user-defined function pointers is given below.

```
int user_defined_collation_compare( void* udp,
                                   int lenA, const void *strA,
                                   int lenB, const void *strB )
```

This is the function type of a user-defined collation comparison function. The first parameter is the user-data pointer passed into `sqlite3_create_collation_xxx()` as the fourth parameter. The parameters that follow pass in the length and buffer pointers for two strings. The strings will be in whatever encoding was defined by the register function. You cannot assume the strings are null-terminated.

The return value should be negative if string A is less than string B (that is, A sorts before B), 0 if the strings are considered equal, and positive if string A is greater than B (A sorts after B). In essence, the return value is the ordering of A minus B.

```
void user_defined_collation_destroy( void *udp )
```

This is the function type of the user-defined collation destroy function. The only parameter is the user-data pointer passed in as the fourth parameter to `sqlite3_create_collation_v2()`.

Although collation functions have access to a user-data pointer, they don't have an `sqlite3_context` pointer. That means there is no way to communicate an error back to the SQLite engine. As such, if you have a complex collation function, you should try to eliminate as many error sources as you can. Specifically, that means it is a good idea to pre-allocate any working buffers you might need, as there is no way to abort a comparison if your memory allocations fail. Since the collation function is really just a simple comparison, it is expected to work and provide an answer every time.

Collations can also be dynamically registered on demand. See [sqlite3\\_collation\\_needed\(\)](#) in [Appendix G](#) for more details.

## Collation Example

Here is a simple example of a user-defined collation. In this example, we're defining a `STRINGNUM` collation that can be used to sort string representations of numeric values.

Unless they're the same length, string representations of numbers often sort in odd ways. For example, using standard text sorting rules, the string '485' will sort before the string '73' because the character '4' sorts before the character '7', just as the



character 'D' sorts before the character 'G'. To be clear, these are text strings made up of characters that represent numeric digits, not actual numbers.

The collation attempts to convert these strings into a numeric representation and then use that numeric value for sorting. Using this collation, the string '485' will sort after '73'. To keep things simple, we're only going to deal with integer values:

```
int col_str_num( void *udp,
                int lenA, const void *strA,
                int lenB, const void *strB )
{
    int valA = col_str_num_atoi_n( (const char*)strA, lenA );
    int valB = col_str_num_atoi_n( (const char*)strB, lenB );

    return valA - valB;
}

static int col_str_num_atoi_n( const char *str, int len )
{
    int total = 0, i;
    for ( i = 0; i < len; i++ ) {
        if ( ! isdigit( str[i] ) ) {
            break;
        }
        total *= 10;
        total += digittoint( str[i] );
    }
    return total;
}
```

The collation attempts to convert each string into an integer value using our custom `col_str_num_atoi_n()` function, and then compares the numeric results. The `col_str_num_atoi_n()` function is very similar to the C standard `atoi()` function, with the prime difference that it takes a maximum length parameter. That is required in this case, since the strings passed into our collations may not be null-terminated.

We would register this collation with SQLite like this:

```
sqlite3_create_collation( db, "STRINGNUM", SQLITE_UTF8, NULL, col_str_num );
```

Because the standard C function `isdigit()` is not Unicode aware, our collation sort function will only work with strings that are limited to 7-bit ASCII.

We can then have SQL that looks like this:

```
sqlite> CREATE TABLE t ( s TEXT );
sqlite> INSERT INTO t VALUES ( '485' );
sqlite> INSERT INTO t VALUES ( '73' );
sqlite> SELECT s FROM t ORDER BY s;
485
73
sqlite> SELECT s FROM t ORDER BY s COLLATE STRINGNUM;
73
485
```

It would also be possible to permanently associate our collation with a specific table column by including the collation in the table definition. See [CREATE TABLE](#) in [Appendix C](#) for more details.

## SQLite Extensions

While custom functions are a very powerful feature, they can also introduce undesired dependencies between database files and custom SQLite environments. If a database uses a custom collation in a table definition or a custom function in a view definition, then that database can't be opened by any application (including `sqlite3`) that does not have all the proper custom functions defined.

This normally isn't a big deal for a custom-built application with just a few custom features. You can simply build all the custom code directly into your application. Anytime a database file is created or opened by your application, you can create the appropriate function bindings and make your custom function definitions available for use by the database files.

Where things get tricky is if you need to open your database files in a general purpose application, like the `sqlite3` command-line shell, or one of the third-party GUI database managers. Without some way of bringing your custom functions and features with you, your only choice is to splice your custom-feature code into the source of whatever utilities you require, and build site-specific versions that support your SQL environment. That's not very practical in most cases—especially if the source code to the utility is unavailable.

The solution is to build your custom content as an *extension*. Extensions come in two flavors: static and loadable (dynamic). The difference is in how the extension is built and linked into your main application. The same source can be used to build both a static extension and a loadable extension.

Static extensions can be built and linked directly into an application, not unlike a static C library. Loadable extensions act as external libraries, or “plug-ins,” to the SQLite engine. If you build your extension as an external loadable extension, you can load the extension into (almost) any SQLite environment, making your custom functions and SQL environment available to `sqlite3` or any other database manager.

In both cases, extensions are a handy way to package a set of related functions into one deployable unit. This is particularly useful if you're writing an SQL support library that is used by a large number of applications, or if you're writing an SQLite interface to an existing library. Structuring your code as an extension also provides a standard way to distribute a set of custom functions to other SQLite users. By providing your code as an extension, each developer can choose to build and integrate the extension to best suit their needs, without having to worry about the format or design of the extension code.

Even if you plan on statically linking all of your custom function and feature code directly into your application, there is still great value in packaging your code as an extension. By writing an extension, you don't lose the ability to build and statically link your extension directly into your application, but you gain the ability to build an external loadable module.

Having your extended environment available as a loadable module allows you to re-create your application's SQL environment in the `sqlite3` command-line tool, or any other general purpose database manager. This opens up the ability to interactively examine your database files in order to design and test queries, debug problems, and track down customer support issues. This alone is a strong reason to consider writing all your custom functions as loadable extensions, even if you never plan on releasing or distributing the standalone loadable extensions.

## Extension Architecture

Extensions are nothing more than a style of packaging your code. The SQLite API calls used to register and create custom function handlers, aggregate handlers, collations, or other custom features are completely unchanged in an extension. The only difference is in the initialization process that creates and binds your custom C functions to a database connection. The build process is also slightly different, depending if you want to build a statically linked extension or a dynamically loadable extension, but both types of extensions can be built from the same source code.

Extension architecture focuses on getting dynamically loadable extensions to operate correctly across multiple platforms. The biggest challenge for the dynamic extension architecture is making sure the loadable extension is provided access to the SQLite API. Without getting into a lot of details about how the runtime linker works on different operating systems, the basic issue is that code compiled into an extension and loaded at runtime may not be able to resolve link dependencies from the loadable extension back into the application where the SQLite library sits.

To avoid this problem, when an extension is initialized it is passed a large data structure that contains a C function pointer to every function in the SQLite API. Rather than calling the SQLite functions directly, an extension will dereference the required function pointer and use that. This provides a means to resolve any calls into the SQLite library without depending on the linker. While this isn't fully required for a static extension, the mechanism works equally well with both static and dynamic extensions.

Thankfully, the details of how this big data structure works are all well hidden from the developer by using an alternate header file and a few preprocessor macros. These macros completely hide the whole linker and function pointer issue, but with one limitation: all the extension code that makes calls into the SQLite API must be in the same file, along with the extension initialization function. That code may call out to other files and other libraries, just as long as that "other code" doesn't make any direct calls to *any* `sqlite3_XXX()` function.



For an SQLite extension to work correctly, every function that interacts with the SQLite library must be in the same C source file as the initialization function.

In practice, this is rarely a significant limitation. Keeping your custom SQLite extensions in their own files, out of your application code, is a natural way to organize your code. Most SQLite extensions are a few hundred lines or less, especially if they are simply acting as a glue layer between SQLite and some other library. This can make them large, but usually not so large they become unmanageable as a single file.

## Extension Design

To write an extension, we need to use the extension header file. Rather than using the more common *sqlite.h* file, an extension uses the *sqlite3ext.h* file:

```
#include "sqlite3ext.h"
SQLITE_EXTENSION_INIT1; /* required by SQLite extension header */
```

The SQLite extension header defines two macros. The first of these is `SQLITE_EXTENSION_INIT1`, and should be referenced at the top of the C file that holds the extension source. This macro defines a file-scoped variable that holds a pointer to the large API structure.

Each extension needs to define an *entry point*. This acts as an initialization function for the extension. The entry point function looks like this:

```
int ext_entry_point( sqlite3 *db, char **error,
                    const sqlite3_api_routines *api )
```

This is the prototype of an extension entry point. The first parameter is the database connection that is loading this extension. The second parameter can be used to pass back a reference to an error message, should the extension be unable to properly initialize itself. The last parameter is used to convey a block of function pointers to assist in the linking process. We'll see how this is used in a moment.

This function is called by the SQLite engine when it loads a static or dynamic extension. Typically, this function will create and register any custom functions or other custom extensions with the database connection.

The entry point has two main jobs. The first job is to finish the initialization process by calling the second extension macro. This should be done as the first bit of code in the entry point (the macro expands into a line of code, so if you're working in pure C you will need to put any function-scope variables before the initialization macro). It *must* be done before any `sqlite3_xxx()` calls are made, or the application will crash:

```
int ext_init( sqlite3 *db, char **error, const sqlite3_api_routines *api )
{
    /* local variable definitions */
```

```

        SQLITE_EXTENSION_INIT2(api);
    /* ... */
}

```

This macro is the only time you should need to directly reference the `api` parameter. Once the entry function has finished the extension API initialization, it can proceed with its second main job, which is registering any and all custom functions or features provided by this extension.

Unlike a lot of functions, the name of the entry point function is somewhat important. When a dynamic extension is loaded, SQLite needs to ask the runtime linker to return a function pointer to the entry point function. In order to do this, the name of the entry point needs to be known.

As we'll see when we look at the dynamic load functions, by default SQLite will look for an entry point named `sqlite3_extension_init()`. In theory, this is a good function name to use, since it will allow a dynamic extension to be loaded even if all you know is the filename.

Although the same application can load multiple dynamic extensions, even if they have the same entry point name, that is not true about statically linked extensions. If you need to statically link more than one extension into your application, the entry points must have unique names or the linker won't be able to properly link in the extensions.

As a result, it is customary to name the entry point something that is unique to the extension, but fairly easy to document and remember. The entry point often shares the same name as the extension itself, possibly with an `_init` suffix. The example extension we'll be looking at is named `sql_trig`, so good choices for the entry point would be `sql_trig()` or `sql_trig_init()`.

## Example Extension: `sql_trig`

For our example extension, we will be creating a pair of SQL functions that expose some simple trigonometric functions from the standard C math library. Since this is just an example, we'll only be creating two SQL functions, but you could use the same basic technique to build SQL functions for nearly every function in the standard math library.

The first half of our `sql_trig.c` source file contains the two functions we will be defining in our example extension. The functions themselves are fairly simple, extracting one double-precision floating-point number, converting from degrees to radians, and then returning the result from the math library. I've also shown the top of the file with the required `#include` statements and initialization macros:

```

/* sql_trig.c */

#include "sqlite3ext.h"
SQLITE_EXTENSION_INIT1;

```

```

#include <stdlib.h>

/* this bit is required to get M_PI out of MS headers */
#ifdef _WIN32
#define _USE_MATH_DEFINES
#endif /* _WIN32 */

#include <math.h>

static void sql_trig_sin( sqlite3_context *ctx, int num_values, sqlite3_value **values )
{
    double a = sqlite3_value_double( values[0] );
    a = ( a / 180.0 ) * M_PI; /* convert from degrees to radians */
    sqlite3_result_double( ctx, sin( a ) );
}

static void sql_trig_cos( sqlite3_context *ctx, int num_values, sqlite3_value **values )
{
    double a = sqlite3_value_double( values[0] );
    a = ( a / 180.0 ) * M_PI; /* convert from degrees to radians */
    sqlite3_result_double( ctx, cos( a ) );
}

```

You'll notice these are declared as `static` functions. Making them `static` hides them from the linker, eliminating any possible name conflicts between this extension and other extensions. As long as the extension entry point is in the same file (which, as we've already discussed, is required for other reasons), the entry point will still be able to properly register these functions. Declaring these functions `static` is not strictly required, but doing so is a good practice and can eliminate linking conflicts.

We then need to define our entry point. Here is the second part of the `sql_trig.c` file:

```

int sql_trig_init( sqlite3 *db, char **error, const sqlite3_api_routines *api )
{
    SQLITE_EXTENSION_INIT2(api);

    sqlite3_create_function( db, "sin", 1,
        SQLITE_UTF8, NULL, sql_sin, NULL, NULL );
    sqlite3_create_function( db, "cos", 1,
        SQLITE_UTF8, NULL, sql_cos, NULL, NULL );

    return SQLITE_OK;
}

```

This entry point function should *not* be declared `static`. Both the static linker (in the case of a static extension) and the dynamic linker (in the case of a loadable extension) need to be able to find the entry point function for the extension to work correctly. Making the function `static` would hide the function from the linker.

These two blocks of code make up our entire `sql_trig.c` source file. Let's look at how to build that file as either a static extension or a dynamically loadable extension.

## Building and Integrating Static Extensions

To statically link an extension into an application, you can simply build the extension source file into the application, just like any other `.c` file. If your application code was contained in the file `application.c`, you could build and link our example `sql_trig` extension using the commands shown here.

In the case of most Linux, Unix, and Mac OS X systems, our trig example requires that we explicitly link in the math library (`libm`). In some cases, the standard C library (`libc`) is also required. Windows includes the math functions in the standard runtime libraries, so linking in the math library is not required.

Unix and Mac OS X systems (with math lib):

```
$ gcc -o application application.c sqlite3.c sql_trig.c -lm
```

Windows systems, using the Visual Studio compiler:

```
> cl /Feapplication application.c sqlite3.c sql_trig.c
```

These commands should produce an executable named `application` (or `application.exe` under Windows).

Just linking the code together doesn't magically make it integrate into SQLite. You still need to make SQLite aware of the extension so that the SQLite library can initialize the extension correctly:

```
int sqlite3_auto_extension( entry_point_function );
```

Registers an extension entry point function with the SQLite library. Once this is done, SQLite will automatically call an extension's entry point function for every database connection that is opened. The only parameter is a function pointer to the entry point.

This function only works with statically linked extensions and does not work with dynamically loadable extensions. This function can be called as many times as is necessary to register as many unique entry points as are required.

This function is called by an application, typically right after calling `sqlite3_initialize()`. Once an extension's entry point is registered with the SQLite library, SQLite will initialize the extension for each and every database connection it opens or creates. This effectively makes your extension available to all database connections managed by your application.

The only odd thing about `sqlite3_auto_extension()` is the declaration of the entry point function. The auto extension API call declares the function pointer to have a type of `void entry_point( void )`. That defines a function that takes no parameters and returns no value. As we've already seen, the actual extension entry point has a slightly more complex prototype.

The code that actually calls the extension first casts the provided function pointer to the correct type, so the fact that the types don't match is only an issue for setting the pointer. Extensions typically don't have header files, since the entry point function would typically be the only thing in a header. To get everything working, you can either provide the proper prototype for the entry point and then cast back to what the API is expecting, or you can simply declare the function prototype incorrectly, and let the linker match things up. Pure C doesn't type-check function parameters when it links, so this will work, even if it isn't the most elegant approach.

Here's what the proper prototype with a cast might look like in our application code:

```
/* declare the (correct) function prototype manually */
int sql_trig_init( sqlite3 *db, char **error, const sqlite3_api_routines *api );

/* ... */
sqlite3_auto_extension( (void*)(void)sql_trig_init ); /* needs cast */
/* ... */
```

Or, if you're working in pure C, you can just declare a different prototype:

```
/* declare the (wrong) function prototype manually */
void sql_trig_init(void);

/* ... */
sqlite3_auto_extension( sql_trig_init );
/* ... */
```

As long as the actual `sql_trig_init()` function is in a different file, this will compile and link correctly, resulting in the desired behavior.

If you want a quick practical example of how to add a static extension to an existing application, we can add our `sql_trig` extension to the `sqlite3` shell with a minimum number of changes. We'll need our `sql_trig.c` file, which contains the two SQL trig functions, plus the `sql_trig_init()` entry function. We'll also need the `shell.c` source code for the `sqlite3` command-line application.

First, we need to add some initialization hooks into the `sqlite3` source. Make a copy of the `shell.c` file as `shell_trig.c`. Open your new copy and search for the phrase “`int main()`” to quickly locate the starting point of the application. Right before the main function, in global file scope, add a prototype for our `sql_trig_init()` entry point:

```
/* ... */
void sql_trig_init(void); /* insert this line */

int main(int argc, char **argv){
/* ... */
```

Then, inside the existing `main()` function, search for a call to “`open_db()`” to find a good spot to insert our code. Right before the small block of code (and comments) that contains the first call to `open_db()`, add this line:

```
sqlite3_auto_extension( sql_trig_init );
```



With those two edits, you can save and close the `shell_trig.c` file. We can then recompile our modified `shell_trig.c` source into a custom `sqlite3trig` utility that has our extension built into it.

Unix/Linux and Mac OS X:

```
$ gcc -o sqlite3trig sqlite3.c shell_trig.c sql_trig.c -lm
```

Windows:

```
> cl /Fesqlite3trig sqlite3.c shell_trig.c sql_trig.c
```

Our new `sqlite3trig` application now has our extension built directly into it, and our functions are accessible from any database that is opened with our modified `sqlite3trig` utility:

```
$ ./sqlite3trig
SQLite version 3.X.XX
Enter ".help" for instructions
Enter SQL statements terminated with a ";"
sqlite> SELECT sin( 30 );
0.5
sqlite> SELECT cos( 30 );
0.866025403784439
```

Although we had to modify the source, the modifications were fairly small. While we needed to modify and recompile the main application (`sqlite3trig`, in this case) to integrate the extension, you can see how easy it would be to add additional extensions.

## Using Loadable Extensions

Dynamic extensions are loaded on demand. An application can be built without any knowledge or understanding of a specific extension, but can still load it when requested to do so. This means you can add new extensions without having to rebuild or recompile an application.

Loadable extension files are basically shared libraries in whatever format is appropriate for the platform. Loadable extensions package compiled code into a format that the operating system can load and link into your application at runtime. [Table 9-1](#) provides a summary of the appropriate file formats on different platforms.

*Table 9-1. Summary of loadable extension file format*

Platform	File type	Default file extension
Linux and most Unix	Shared object file	<code>.so</code>
Mac OS X	Dynamic library	<code>.dylib</code>
Windows	Dynamically linked library	<code>.DLL</code>

Loadable extensions are not supported on all platforms. Loadable extensions depend on the operating system having a well-supported runtime linker, and not all handheld and embedded devices offer this level of support. In general, if a platform supports some type of dynamic or shared library for application use, there is a reasonable chance the loadable extension interface will be available. If the platform does not support dynamic or shared libraries, you may be limited to statically linked extensions. However, in most embedded environments this isn't a major limitation.

Although the file formats and extensions are platform dependent, it is not uncommon to pick a custom file extension that is used across all your supported platforms. Using a common file extension is not required, but it can keep the cross-platform C or SQL code that is responsible for loading the extensions a bit simpler. Like database files, there is no official extension for an SQLite loadable extension, but *.sqlite3ext* is sometimes used. That's what I'll use in our examples.

## Building Loadable Extensions

Generally, building a loadable extension is just like building a dynamic or shared library. The code must first be compiled into an object file (a *.o* or *.obj* file) and that file must be packaged into a shared or dynamic library. The process of building the object file is exactly the same for both static and dynamic libraries. You can build the object file directly with one of these commands.

Mac OS X and Unix/Linux:

```
$ gcc -c sql_trig.c
```

Windows:

```
> cl /c sql_trig.c
```

Once you have the object file, that needs to be converted into a dynamic or shared library using the linker. The commands for that are a bit more platform dependent.

First, the Unix and Linux command, which builds a shared object file and links in the standard math library:

```
$ ld -shared -o sql_trig.sqlite3ext sql_trig.o -lm
```

Mac OS X, which uses dynamic libraries, rather than shared object files:

```
$ ld -dylib -o sql_trig.sqlite3ext sql_trig.o -lm
```

And finally, Windows, where we need to build a DLL file. In this case, we need to tell the linker which symbols we want exported. For an extension, only the entry point needs to be exported, so we just include that on the command-line:

```
> link /dll /out:sql_trig.sqlite3ext /export:sql_trig_init sql_trig.obj
```

You can test out your dynamic extension in `sqlite3` using the `.load` command. The command takes two parameters. The first is the filename of your loadable extension, and the second is the name of the entry point function:

```

$ sqlite3
SQLite version 3.X.XX
Enter ".help" for instructions
Enter SQL statements terminated with ";"
sqlite> SELECT sin( 60 );
Error: no such function: sin
sqlite> .load sql_trig.sqlite3ext sql_trig_init
sqlite> SELECT sin( 60 );
0.866025403784439

```

As you can see, when we first start `sqlite3`, it has no awareness of our extension or the SQL functions it contains. The `.load` command is used to dynamically load the extension. Once loaded, our custom trig functions are available without any need to recompile or rebuild the `sqlite3` utility.

## Loadable Extension Security

There are some minor security concerns associated with loadable extensions. Because an extension might contain just about any code, a loadable extension might be used to override application values for the SQLite environment. In specific, if an application uses an authorization function to protect against certain types of queries or modifications, a loadable extension could clear the authorization callback function, eliminating any authorization step (see `sqlite3_set_authorizer()` in [Appendix G](#) for more details).

To prevent this, and other possible issues, an application must explicitly enable the ability to load external extensions. This has to be done each time a database connection is established.

```
int sqlite3_enable_load_extension( sqlite3 *db, int onoff )
```

Enables or disables the ability to load dynamic extensions. *Loadable extensions are off by default.*

The first parameter is the database connection to set. The second parameter should be true (nonzero) to enable extensions, or false (zero) to disable them. This function always returns `SQLITE_OK`.

Most general purpose applications, including the `sqlite3` shell, automatically enable loadable extensions for every database they open. If your application will support loadable extensions, you will need to enable this as well. Extension loading needs to be enabled for each database connection, every time the database connection is opened.

## Loading Loadable Extensions

There are two ways to load an extension. One is through a C API call, and one is through an SQL function that calls down into the same code as the C API function. In both cases, you provide a filename and, optionally, the name of the entry point function.

```
int sqlite3_load_extension( sqlite3 *db, const char *ext_name,
                           const char *entry_point, char **error )
```

Attempts to load a loadable extension and associate it to the given database connection. The first parameter is the database connection to associate with this extension. The second parameter is the filename of the extension. The third parameter is the name of the entry point function. If the entry point name is NULL, the entry point `sqlite3_extension_init` is used. The fourth parameter is used to pass back an error message if something goes wrong. This string buffer should be released with `sqlite3_free()`. This last parameter is optional and can be set to NULL.

This will return either `SQLITE_OK`, to indicate the extension was loaded and the initialization function was successfully called, or it may return `SQLITE_ERROR` to indicate something went wrong. If an error condition is returned, there may or may not be a valid error string.

This function is typically called as soon as a database connection is opened, before any statements are prepared. Although it is legal to call `sqlite3_load_extension()` at any time, any API calls made by the extension entry point and initialization function are subject to standard restrictions. In specific, that means any calls to `sqlite3_create_function()` made by the extension entry point function will fail to redefine or delete a function if there are any executing SQL statements.

The other way to load a loadable extension is with the built-in SQL function `load_extension()`.

```
load_extension( 'ext_name' )
load_extension( 'ext_name', 'entry_point' )
```

This SQL function loads the extension with the given filename. If an entry point name is given, that is used as the initialization function. If not, the name `sqlite3_extension_init` will be used.

This function is similar to the C `sqlite3_load_extension()` call, with one major limitation. Because this is an SQL function, when it is called there will be, by definition, an SQL statement executing when the extension is loaded. That means that any extension loaded with the `load_extension()` SQL function will be completely unable to redefine or delete a custom function, including the specialized set of `like()` functions.

To avoid this problem while testing your loadable extensions in the `sqlite3` shell, use the `.load` command. This provides direct access to the C API call, allowing you to get around the limitations in the SQL function. See [.load](#) in [Appendix B](#) for more details.

No matter which mechanism you use to load a loadable extension, you'll need to do it for each database connection your application opens. Unlike the `sqlite3_auto_extension()` function, there is no automatic way to import a set of loadable extensions for each and every database.

The only way to completely unload a loadable extension is to close the database connection.

## Multiple Entry Points

Although most extensions have only a single entry point function, there is nothing that says this must be true. It is perfectly acceptable to define multiple entry points in a single extension—just make sure they each call `SQLITE_EXTENSION_INIT2()`.

Multiple entry points can be used to control the number of imported functions. For example, if you have a very large extension that defines a significant number of functions in several different subcategories, you would likely define one main entry point that imports every extension, aggregation, collation, and other features with one call. You could also define an entry point for each subcategory of functionality, or one entry point for all the functions, one for all the collations, etc. You might also define one entry point to bind UTF-8 functions, and another for UTF-16.

No matter how you want to mix and match things, this allows an extension user to import just the functionality they need. There is no danger in redefining a function from two different entry points (assuming all of the entry points register similar functions in similar ways), so different entry points can register overlapping sets of functions without concern.

Even if your extension is not large and doesn't really justify multiple entry points, a second one can still be handy. Some extensions define a “clear” entry point, for example, `sql_trig_clear()`. This would typically be very similar to the `_init()` entry point function, but rather than binding all the function pointers into a database connection, it would bind all NULL pointers. This effectively “unloads” the extension from the SQL environment—or at least removes all the functions it created. The extension file may still be in memory, but the SQL functions are no longer available to that database connection. The only thing to remember about a `_clear()` entry point is that it cannot be called while an SQL statement is being executed, because of the redefine/delete rules for functions like `sqlite3_create_function()`. This also means you cannot call a `_clear()` entry point using the SQL function `load_extension()`.

## Chapter Summary

Custom functions, aggregations, and collations can be an extremely powerful means to extend and expand the SQL environment to fit your own needs and designs. Extensions make for a relatively painless way to modularize and compartmentalize those custom features. This makes the extension code easier to test, support, and distribute.

In the next chapter, we'll look at one of the more powerful customizations in SQLite: virtual tables. Virtual tables allow a developer to merge the SQLite environment to just about any data source. Like other custom features, the easiest way to write a virtual table is to use an extension.



---

# Virtual Tables and Modules

This chapter looks at how to use and write virtual tables. A *virtual table* is a custom extension to SQLite that allows a developer to define the structure and contents of a table through code. To the database engine, a virtual table looks like any other table—a virtual table can be queried, updated, and manipulated using the same SQL commands that are used on other tables. The main difference is where the table data comes from. When processing a normal table, the SQLite library might access a database file to retrieve row and column values. In the case of a virtual table, the SQLite library calls in to your code to perform these functions and return data values. Your functions, in turn, can gather or calculate the requested data from whatever sources you want.

Developing a virtual table implementation, which is known as an SQLite *module*, is a fairly advanced feature. This chapter should give you a good idea of what virtual tables are capable of doing and the basics of how to write your own module. We'll be walking through the code for two different modules. The first is a fairly simple one that exposes some internal SQLite data as a table. The second example will allow read-only access to standard Apache *httpd* server logs.

This chapter should provide a solid starting point. However, if you find yourself having to write a more robust module, you may need to dig a bit deeper into the development documentation, found at <http://www.sqlite.org/vtab.html>. I would also suggest having a look at the source code to some of the other modules out there (including those that ship with SQLite) to get a better idea of how the advanced features work. Modules are complex enough that sometimes it is easier to modify an existing module, rather than implementing everything from the ground up.

Like the last chapter, this type of advanced development is usually best learned hands-on. To help with this, the full source to both examples is available in the book download. See “[Example Code Download](#)” on page [xvi](#) for more details.

# Introduction to Modules

Virtual tables are typically used to link the SQLite database engine to an alternate data source. There are two general categories of virtual tables: internal and external. There aren't any implementation differences between the categories, they just provide a rough way to define a module's functionality.

## Internal Modules

Internal modules are self-contained within the database. That is, the virtual table acts as a fancy front-end to more traditional database tables that are created and maintained by the virtual table module. These back-end tables are sometimes known as *shadow tables*. Most importantly, all the data used by the module is still stored within the database file. These types of modules typically provide a specialized type of indexing or lookup feature that is not well suited to the native database indexes. Internal virtual tables may require multiple shadow tables to efficiently operate.

The two largest modules included in the SQLite distribution (FTS3 and R\*Trees) are both internal style modules. Both of these modules create and configure several standard tables to store and index the data they've been asked to maintain.

Generally, internal modules are used to improve or extend the data manipulation facilities of a database. In most cases, an internal virtual table isn't doing anything an SQL developer couldn't do on their own, the module is just making it easier or faster (or both). Internal modules often play the role of an abstract "smart view" that offers highly optimized access patterns to specific types of data or specific structures of data. Both the Full Text Search module and the R\*Tree module are prime examples of modules that provide highly specialized searches on specific types and structures of data.

## External Modules

The other major category of modules are external modules. These are modules that interface with some type of external data source. That data source might be something as simple as an external file. For example, a module could expose a CSV file or Excel file as an SQL table within the database. Pretty much any structured file can be exposed this way. An external module can also be used to present other data sources to the SQLite database engine. You could actually write an SQLite module that exposed tables from a MySQL database to the SQLite database engine. Or, for something a bit more unusual, have the query `SELECT ip FROM dns WHERE hostname = 'www.oreilly.com'` go out and process a DNS request. External modules can get quite exotic.

In the case of external modules, it is important to understand that the data is not imported or copied into the SQLite database. Rather than loading the data into standard tables and allowing you to access it from there, an external module acts as a real-time



translator between the SQLite data structures and whatever external data source you wish to access. Modules will typically reflect changes to their data source in real time.

Of course, you can use an external module as an importer by copying the data from a virtual table to a standard table with an `INSERT...SELECT` statement. If the module has full read/write support, you can even use it as an exporter by copying data from the database into the virtual table. By using this technique, I've seen cases of SQLite being used as a "universal translator" for several different external data formats. By writing a virtual table module that can speak to each file format, you can easily and quickly move data between supported formats.

## Example Modules

To help explain how modules work, we're going to work through two examples. The first example is a very simple internal module that exposes the output of the `PRAGMA database_list` command as a full-blown table. This allows you to run `SELECT` queries (including `WHERE` constraints) against the current database list. Although this module is read-only and extremely simple, it should serve as a good first introduction to the module system.

The second example is a bit more in-depth. We'll be looking at building an external module that exposes Apache `httpd` server logs to the database engine. This allows a webmaster to run SQL queries directly against a logfile (including the active logfile) without having to first import the data into a traditional database table.

## SQL for Anything

As we'll see with the webserver logfile example, developing an external SQLite module can be an easy way to provide generic search-and-report services to arbitrary data formats. In the case of webserver logs, many server administrators have a stash of scripts and utilities they use for logfile analysis. While these can work quite well for clearly defined tasks, such scripts often require significant code modifications to alter search parameters or report formats. This can make custom scripts difficult to modify and somewhat inflexible.

Webserver log analysis is a common enough problem that there are some extremely powerful general purpose packages available for download. Some of these packages are quite robust and impressive, but to use them effectively requires understanding and experience with the package and the tools that it provides.

With the external data module, you can simply attach the SQLite engine directly to your logfiles, making the logs appear as a big (and constantly updating) table. Once this is done, you have the whole power of the relational database engine at your disposal. Best of all, the queries and searches are all defined in SQL, a language that many web administrators already know. Report generation becomes a snap and, when combined with the `sqlite3` command-line utility, the module will enable real-time

interaction with the live log data. This allows a system administrator faced with a security or performance incident to quickly formulate and execute arbitrary searches and summary reports interactively, in a language and environment they're already comfortable using.

This is one of the more compelling uses of virtual tables. While there are many instances of applications that can take advantage of the custom index formats and improved search features offered by some virtual tables, the true magic happens with external modules. The ability to integrate any regular data source into a full SQL environment makes for an extremely powerful and enabling tool, especially in cases where there is a need to directly interact with the data in real time.

The next time you're thinking about clobbering together some scripts to scan or filter a structured data source, ask yourself how hard it would be to write an SQLite module instead. Modules can definitely be tricky to write, but once you have a working module, you also have the full power of the SQL language at your hands.

## Module API

The virtual table API is one of the more advanced SQLite APIs. In specific, it does very little hand-holding and will often fool those that make assumptions. The functions you need to write are often required to do a very specific set of operations. If you fail to do any one of those, or forget to initialize a data structure field, the result might very well be a bus error or segmentation fault.

That street goes two ways, however. While the SQLite core expects you to do your job, it does a very good job of always doing its job in a very predictable and documented way. Most of this code operates fairly deeply in the SQLite core, and SQLite does a solid job of protecting your code against odd user behavior. For example, none of the example code checks for NULL parameter values, as you can be sure SQLite will never allow a NULL database pointer (or some equally critical parameter) to be passed into your function.

Implementing a virtual table module is a bit like developing an aggregate function, only a lot more complex. You must write a series of functions that, taken together, define the behavior of the module. This block of functions is then registered under a module name.

```
int sqlite3_create_module( sqlite3 *db, const char *name,  
                          const sqlite3_module *module, void *udp )
```

Creates and registers a virtual table module with a database connection. The second parameter is the name of the module. The third parameter is a block of function pointers that implements the virtual table. This pointer must remain valid until the SQLite library is shut down. The final parameter is a generic user-data pointer that is passed to some of the module functions.

```
int sqlite3_create_module_v2( sqlite3 *db, const char *name,
                             const sqlite3_module *p, void *udp,
                             destroy_callback )
```

The v2 version of this function is identical to the original function, except for an additional fifth parameter. This version adds a destroy callback of the form `void callback(void *udp)`. This function can be used to release or otherwise clean up the user-data pointer, and is called when the entire module is unloaded. This is done when the database is shut down, or when a new module with the same name is registered in place of this one. The destroy function pointer is optional, and can be set to NULL.

Function pointers are passed in through an `sqlite3_module` structure. The main reason for this is that there are nearly 20 functions that define a virtual table. All but a few of those functions are mandatory.

A module defines a specific type of virtual table. Once a module has been successfully registered, an actual table instance of that type must be created using the SQL command `CREATE VIRTUAL TABLE`. A single database may have multiple instances of the same type of virtual table. A single database may also have different types of virtual tables, just as long as all the modules are properly registered.

The syntax for the `CREATE VIRTUAL TABLE` command looks something like this:

```
CREATE VIRTUAL TABLE table_name USING module_name( arg1, arg2, ... )
```

A virtual table is named, just like any other table. To define the table, you must provide the module name and any arguments the module requires. The argument block is optional, and the exact meaning of the arguments is up to the individual module implementations. It is the responsibility of the module to define the actual structure (column names and types) of the table. The arguments have no predefined structure and do not need to be valid SQL expressions or column definitions. Each argument is passed as a literal text value to the module, with only the leading and trailing whitespace trimmed. Everything else, including whitespace within the argument, is passed as a single text value.

Here is a quick overview of the different functions that are defined by `sqlite3_module` structure. When we look at the example modules, we'll go back through these one at a time in much more detail. The module functions are divided up into three rough groups. The first set of functions operate on table instances. The second set includes the functions that scan a table and return data values. The last group of functions deals with implementing transaction control. To implement a virtual table module, you will need to write a C function that performs each of these tasks.

Functions that deal with individual table instances include:

`xCreate()`

Required. Called when a virtual table instance is first created with the `CREATE VIRTUAL TABLE` command.

#### xConnect()

Required, but frequently the same as xCreate(). Very similar to xCreate(), this is called when a database with an existing virtual table instance is loaded. Called once for each table instance.

#### xDisconnect()

Required. Called when a database containing a virtual table instance is detached or closed. Called once for each table instance.

#### xDestroy()

Required, but frequently the same as xDisconnect(). Very similar to xDisconnect(), this is called when a virtual table instance is destroyed with the DROP TABLE command.

#### xBestIndex()

Required. Called, sometimes several times, when the database engine is preparing an SQL statement that involves a virtual table. This function is used to determine how to best optimize searches and queries made against the table. This information helps the optimizer understand how to get the best performance out of the table.

#### xUpdate()

Optional. Called to modify (INSERT, UPDATE, or DELETE) a table row. If this function is not defined, the virtual table will be read-only.

#### xFindFunction()

Optional. Called when preparing an SQL statement that uses virtual table values as parameters to an SQL function. This function allows the module to override the default implementation of any SQL function. This is typically used in conjunction with the SQL functions like() or match() to define module-specific versions of these functions (and, from that, module-specific versions of the LIKE and MATCH SQL expressions).

#### xRename()

Required. Called when a virtual table is renamed using the ALTER TABLE...RENAME command.

The second group of functions deals with processing table scans. These functions operate on a *table cursor*, which holds all of the state information required to perform a table scan. As the database engine scans a table and steps through each individual row, the cursor is responsible for keeping track of which row is being processed.

A single virtual table instance may be involved in more than one table scan at a time. To function correctly, the module must keep all state information in the table cursor, and cannot use user-data pointers or static variables. Consider, for example, a virtual table instance that is self-joined, and must have more than one scan active at the same time.

Cursor functions include:

`xOpen()`

Required. Called to create and initialize a table cursor.

`xClose()`

Required. Called to shut down and release a table cursor.

`xFilter()`

Required. Called to initiate a table scan and provide information about any specific conditions put on this particular table scan. Conditions typically come from `WHERE` constraints on the query. The `xFilter()` function is designed to work in conjunction with `xBestIndex()` to allow a virtual table to pre-filter as many rows as it can. After readying the module for a table scan, `xFilter()` should also look up the first row. This may be called more than once between `xOpen()` and `xClose()`.

`xNext()`

Required. Called to advance a table cursor to the next row.

`xEOF()`

Required. Called to see if a table cursor has reached the end of the table or not. EOF is traditional shorthand for *end-of-file*. This function is always called right after a call to `xFilter()` or `xNext()`.

`xRowid()`

Required. Called to extract the virtual `ROWID` of the current row.

`xColumn()`

Required. Called to extract a column value for the current row. Normally called multiple times per row.

Finally, we have the transaction control functions. These allow external data sources to take part in the transaction control process, and include:

`xBegin()`

Optional. Called when a transaction is started.

`xSync()`

Optional. Called to start committing a transaction.

`xCommit()`

Optional. Called to finalize a database transaction.

`xRollback()`

Optional. Called to roll back a database transaction.

If this sounds confusing, don't give up just yet. As we start to work through the code examples, we will go back through each function and take a closer look at all the details.

You may be surprised to see that the transactional functions are optional. The reason for this is that internal modules don't need or require their own transactional control. When an internal module modifies any standard table in response to a virtual table operation, the normal transactional engine is already protecting those changes and

updates. Additionally, external read-only modules don't require transactional control because they aren't driving any modifications to their external data sources. The only type of module that really needs to implement transactional control are those that provide transaction-safe read/write support to external data sources.

## Simple Example: dblast Module

The first example takes the output of the `PRAGMA database_list` command and presents it as a table. Since the output from the `PRAGMA` command is already in the same structure as a table, this conversion is fairly simple. The main reason for doing this is to use the full `SELECT` syntax, including `WHERE` conditions, against the virtual table. This is not possible with the `PRAGMA` command.

The `PRAGMA database_list` command normally returns three columns: `seq`, `name`, and `file`. The `seq` column is a sequence value that indicates which "slot" the database is attached to. The `name` column is the logical name of the database, such as `main` or `temp`, or whatever name was given to the `ATTACH DATABASE` command. (See [ATTACH DATABASE](#) in [Appendix C](#)). The `file` column displays the full path to the database file, if such a file exists. In-memory databases, for example, do not have any associated filenames.

To keep things simple, the module uses the `seq` value as our virtual `ROWID` value. The `seq` value is an integer value and is unique across all of the active databases, so it serves this purpose quite well.

## Create and Connect

The first set of functions we'll be looking at are used to create or connect a virtual table instance. The functions you need to provide are:

```
int xCreate( sqlite3 *db, void *udp,
            int argc, char **argv,
            sqlite3_vtab **vtab, char **errMsg )
```

Required. This function is called by SQLite in response to a `CREATE VIRTUAL TABLE` command. This function creates a new instance of a virtual table and initializes any required data structures and database objects.

The first parameter is the database connection where the table needs to be created. The second parameter is the user-data pointer passed into `sqlite3_create_module()`. The third and fourth parameters pass in a set of creation arguments. The fifth parameter is a reference to a virtual table (`vtab`) structure pointer. Your function must allocate and return one of these structures. The final parameter is a reference to an error message. This allows you to pass back a custom error message if something goes wrong.

If everything works as planned, this function returns `SQLITE_OK`. If the return code is anything other than `SQLITE_OK`, the `vtab` structure should *not* be allocated.

Every module is passed at least three arguments. The variable `argv[0]` will always contain the name of the module used to create the virtual table. This allows the same `xCreate()` function to be used with similar modules. The logical name of the database (`main`, `temp`, etc.) is passed in as `argc[1]`, and `argv[2]` contains the user-provided table name. Any additional arguments given to the `CREATE VIRTUAL TABLE` statement will be passed in, starting with `argv[3]`, as text values.

```
int xConnect( sqlite3 *db, void *udp,
             int argc, char **argv,
             sqlite3_vtab **vtab, char **errMsg )
```

Required. The format and parameters of this function are identical to `xCreate()`. The main difference is that `xCreate()` is only called when a virtual table instance is first created. `xConnect()`, on the other hand, is called any time a database is opened. The function still needs to allocate and return a `vtab` structure, but it should not need to initialize any database objects.

If no object creation step is required, many modules use the same function for both `xCreate()` and `xConnect()`.

These functions bring a virtual table instance into being. For each virtual table, only one of these functions will be called over the lifetime of a database connection.

The create and connect functions have two major tasks. First, they must allocate an `sqlite3_vtab` structure and pass that back to the SQLite engine. Second, they must define the table structure with a call to `sqlite3_declare_vtab()`. The `xCreate()` call must also create and initialize any storage, be it shadow tables, external files, or whatever is required by the module design. The order of these tasks is not important, so long as all of the tasks are accomplished before the `xCreate()` or `xConnect()` function returns.

### Allocate the vtab structure

The `xCreate()` and `xConnect()` functions are responsible for allocating and passing back an `sqlite3_vtab` structure. That structure looks like this:

```
struct sqlite3_vtab {
    const sqlite3_module *pModule; /* module used by table */
    int nRef; /* SQLite internal use only */
    char *zErrMsg; /* Return error message */
};
```

The module is also (eventually) responsible for deallocating this structure, so you can technically use whatever memory management routines you want. However, for maximum compatibility, it is strongly suggested that modules use `sqlite3_malloc()`. This will allow the module to run in any SQLite environment.

The only field of interest in the `sqlite3_vtab` structure is the `zErrMsg` field. This field allows a client to pass a custom error message back to the SQLite core if any of the functions (other than `xCreate()` or `xConnect()`) return an error code. The `xCreate()` and

`xConnect()` functions return any potential error message through their sixth parameter, since they are unable to allocate and pass back a `vtab` structure (including the `zErrMsg` pointer) unless the call to `xCreate()` or `xConnect()` was successful. The `xCreate()` and `xConnect()` functions initialize the `vtab` error message pointer to `NULL` after allocating the `vtab` structure.

Typically, a virtual table needs to carry around a lot of state. In many systems, this is done with some kind of user-data pointer or other generic pointer. While the `sqlite3_create_module()` function does allow you to pass in a user-data pointer, that pointer is only made available to the `xCreate()` and `xConnect()` functions. Additionally, the same user-data pointer is provided to every table instance managed by a given module, so it isn't a good place to keep instance-specific data.

The standard way of providing instance-specific state data is to wrap and extend the `sqlite3_vtab` structure. For example, our `dblist` module will define a custom `vtab` data structure that looks like this:

```
typedef struct dblist_vtab_s {
    sqlite3_vtab      vtab; /* this must go first */
    sqlite3           *db;  /* module-specific fields then follow */
} dblist_vtab;
```

By defining a custom data structure, the module can effectively extend the standard `sqlite3_vtab` structure with its own data. This will only work if the `sqlite3_vtab` structure is the first field, however. It must also be a vanilla C struct, and not a C++ class or some other managed object. Also, note that the `vtab` field is a full instance of the `sqlite3_vtab` structure, and not a pointer. That is, the custom `vtab` structure “contains-a” `sqlite3_vtab` structure, and does not “references-a” `sqlite3_vtab` structure.

It might seem a bit ugly to append module instance data to the `sqlite3_vtab` structure in this fashion, but this is how the virtual table interface is designed to work. In fact, this is the whole reason why the `xCreate()` and `xConnect()` functions are responsible for allocating the memory required by the `sqlite3_vtab` structure. By having the module allocating the memory, it can purposely overallocate the structure for its own means.

In the case of the `dblist` module, the only additional parameter the module requires is the database connection. Most modules require a lot more information. In specific, the `xCreate()` and `xConnect()` functions are the only time the module code will have access to the user-data pointer, the database connection pointer (the `sqlite3` pointer), the database name, or the virtual table name. If the module needs access to these later, it needs to stash copies of this data in the `vtab` structure. The easiest way to make copies of these strings is with `sqlite3_mprintf()`. (See [`sqlite3\_mprintf\(\)`](#) in [Appendix G](#).)

Most internal modules will need to make a copy of the database connection, the name of the database that contains the virtual module, and the virtual table name. Not only is this information required to create any shadow tables (which happens in `xCreate()`), but this information is also required to prepare any internal SQL statements (typically in `xOpen()`), as well as deal with `xRename()` calls. One of the most common



bugs in module design is to assume there is only one database attached to the database connection, and that the virtual table is living in the `main` database. Be sure to test your module when virtual tables are created and manipulated in other databases that have been opened with `ATTACH DATABASE`.

The `dblist` module doesn't have any shadow tables, and the data we need to return is specific to the database connection, not any specific database. The module still needs to keep a copy of the database connection, so that it can prepare the `PRAGMA` statement, but that's it. As a result, the `dblist_vtab` structure is much simpler than most internal structures.

### Define the table structure

The other major responsibility of the `xCreate()` and `xConnect()` functions is to define the structure of the virtual table.

```
int sqlite3_declare_vtab( sqlite3 *db, const char *sql )
```

This function is used to declare the format of a virtual table. This function may only be called from inside a user-defined `xCreate()` or `xConnect()` function. The first parameter is the database connection passed into `xCreate()` or `xConnect()`. The second parameter is a string that should contain a single, properly formed `CREATE TABLE` statement.

Although the module must provide a table name in the `CREATE TABLE` statement, the table name (and database name, if provided) is ignored. The given name does not need to be the name of the virtual table instance. In addition, any constraints, default values, or key definitions within the table definition are also ignored—this includes any definition of an `INTEGER PRIMARY KEY` as a `ROWID` alias. The only parts of the `CREATE TABLE` statement that really matters are the column names and column types. Everything else is up to the virtual table module to enforce.

Like standard tables, virtual tables have an implied `ROWID` column that must be unique across all of the rows in the virtual table. Most of the virtual table operations reference rows by their `ROWID`, so a module will need some way to keep track of that value or generate a unique `ROWID` key value for every row the virtual table manages.

The `dblist` virtual table definition is quite simple, reflecting the same structure as the `PRAGMA database_list` output. Since the table structure is also completely static, the code can just define the SQL statement as a static string:

```
static const char *dblist_sql =
"CREATE TABLE dblist ( seq INTEGER, name TEXT, file TEXT );";

/* ... */
sqlite3_declare_vtab( db, dblist_sql );
```

Depending on the design requirements, a module might need to dynamically build the table definition based off the user-provided `CREATE VIRTUAL TABLE` arguments.

It was already decided that the `dblist` example will simply use the `seq` values returned by the `PRAGMA` command as the source of both the `seq` output column and the `ROWID` values. Virtual tables have no implicit way of aliasing a standard column to the `ROWID` column, but a module is free to do this explicitly in the code.

It makes sense for a virtual table to define its own structure, rather than having it defined directly by the `CREATE VIRTUAL TABLE` statement. This allows the application to adapt to fit its own needs, and tends to greatly simplify the `CREATE VIRTUAL TABLE` statements. There is one drawback, however, in that if you want to look up the structure of a virtual table, you cannot simply look in the `sqlite_master` system table. Each virtual table instance will have an entry in this table, but the only thing you'll find there is the original `CREATE VIRTUAL TABLE` statement. If you want to look up the column names and types of a virtual table instance, you'll need to use the command `PRAGMA table_info( table_name )`. This will provide a full list of all the column names and types in a table, even for a virtual table. See [table\\_info](#) in [Appendix F](#) for more details.

### Storage initialization

If a virtual table module manages its own storage, the `xCreate()` function needs to allocate and initialize the required storage structure. In the case of an internal module that uses shadow tables, the module will need to create the appropriate tables. Only the `xCreate()` function needs to do this. The next time the database is opened, `xConnect()`, and not `xCreate()`, will be called. The `xConnect()` function may want to verify the correct shadow tables exist in the correct database, but it should not create them.

If you're writing an internal module that uses shadow tables, it is customary to name the shadow tables after the virtual table. In most cases you'll also want to be sure to create the shadow tables in the same database as the virtual table. For example, if your module requires three shadow tables per virtual table instance, such as `Data`, `IndexA`, and `IndexB`, a typical way to create the tables within your `xCreate()` function would be something like this (see `sqlite3_mprintf()` in [Appendix G](#) for details on the `%w` format):

```
sql_cmd1 = sqlite3_mprintf(
    "CREATE TABLE \"%w\".\"%w_Data\" (...)", argv[1], argv[2],... );
sql_cmd2 = sqlite3_mprintf(
    "CREATE TABLE \"%w\".\"%w_IndexA\" (...)", argv[1], argv[2],... );
sql_cmd3 = sqlite3_mprintf(
    "CREATE TABLE \"%w\".\"%w_IndexB\" (...)", argv[1], argv[2],... );
```

This format will properly create per-instance shadow tables in the same database as the virtual table. The double quotes also ensure you can handle nonstandard identifier names. You should use a similar format (with a fully quoted database name and table name) in every SQL statement your module may generate.

If you're writing an external module that manages its own files, or something similar, you should try to follow some similar convention. Just remember *not* to use the database name (`argv[1]`) in your naming convention, as this can change, depending on how the database was opened, or attached to the current database connection.

## Create/connect dblist example

Although the `dblist` module could be considered an internal module, the module does not manage storage for any of the data it uses. This means there is no requirement to create shadow tables. This allows the module to use the same function for both the `xCreate()` and `xConnect()` function pointers.

Here is the full `dblist` create and connect function:

```
static int dblist_connect( sqlite3 *db, void *udp, int argc,
                        const char *const *argv, sqlite3_vtab **vtab, char **errmsg )
{
    dblist_vtab    *v = NULL;

    *vtab = NULL;
    *errmsg = NULL;
    if ( argc != 3 ) return SQLITE_ERROR;
    if ( sqlite3_declare_vtab( db, dblist_sql ) != SQLITE_OK ) {
        return SQLITE_ERROR;
    }

    v = sqlite3_malloc( sizeof( dblist_vtab ) ); /* alloc our custom vtab */
    *vtab = (sqlite3_vtab*)v;
    if ( v == NULL ) return SQLITE_NOMEM;

    v->db = db;
    (*vtab)->zErrMsg = NULL;
    return SQLITE_OK;
}
/* stash this for later */
/* initialize this */
```

The create/connect function walks through the required steps point by point. We verify the argument count (in this case, only allowing the standard three arguments), define the table structure, and finally allocate and initialize our custom `vtab` structure. Remember that you should not pass back an allocated `vtab` structure unless you're returning an `SQLITE_OK` status.

## Disconnect and Destroy

Not surprisingly, the `xCreate()` and `xConnect()` functions each have their own counterparts:

```
int xDisconnect( sqlite3_vtab *vtab )
```

Required. This is the counterpart to `xConnect()`. It is called every time a database that contains a virtual table is detached or closed. This function should clean up any process resources used by the virtual table implementation and release the `vtab` data structure.

```
int xDestroy( sqlite3_vtab *vtab )
```

Required. This is the counterpart to `xCreate()`, and is called in response to a `DROP TABLE` command. If an internal module has created any shadow tables to store module data, this function should call `DROP TABLE` on those tables. As with

`xDisconnect()`, this function should also release any process resources and release the virtual table structure.

Many modules that do not manage their own storage use the same function for `xDisconnect()` and `xDestroy()`.

As with the `xCreate()` and `xConnect()` functions, only one of these functions will be called within the context of a given database connection. Both functions should release the memory allocated to the `vtab` pointer. The `xDestroy()` function should also delete, drop, or deallocate any storage used by the virtual table. Make sure you use fully qualified and quoted database and table names.

The `dblist` version of this function—which covers both `xDisconnect()` and `xDestroy()`—is very simple:

```
static int dblist_disconnect( sqlite3_vtab *vtab )
{
    sqlite3_free( vtab );
    return SQLITE_OK;
}
```

The code frees the `vtab` memory, and that's about it.

## Query Optimization

Virtual tables present a challenge for the query optimizer. In order to optimize `SELECT` statements and choose the most efficient query plan, the optimizer must weigh a number of factors. In addition to understanding the constraints on the query (such as `WHERE` conditions), optimization also requires some understanding of how large a table is, what columns are indexed, and how the table can be sorted.

There is no automatic way for the query optimizer to deduce this information from a virtual table. Virtual tables cannot have traditional indexes, and if the internal virtual table implements a fancy custom indexing system, the optimizer has no way of knowing about it or how to best take advantage of it. While every query could perform a full table scan on a virtual table, that largely defeats the usefulness of many internal modules that are specifically designed to provide an optimized type of lookup.

The solution is to allow the query optimizer to ask the virtual table module questions about the cost and performance of different kinds of lookups. This is done through the `xBestIndex()` function:

```
int xBestIndex( sqlite3_vtab *vtab, sqlite3_index_info *idxinfo )
```

Required. When an SQL statement that references a virtual table is prepared, the query optimizer calls this function to gather information about the structure and capabilities of the virtual table. The optimizer is basically asking the virtual table a series of questions about the most efficient access patterns, indexing abilities, and natural ordering provided by the module. This function may be called several times when a statement is prepared.

Communication between the query optimizer and the virtual table is done through the `sqlite3_index_info` structure. This data structure contains an input and output section. The SQLite library fills out the input section (input to your function), essentially asking a series of questions. You can fill out the output section of the structure, providing answers and expense weightings to the optimizer.

If `xBestIndex()` sounds complicated, that's because it is. The good news is that if you ignore the optimizer, it will revert to a full table scan for all queries and perform any constraint checking on its own. In the case of the `dblist` module, we're going to take the easy way out, and more or less ignore the optimizer:

```
static int dblist_bestindex( sqlite3_vtab *vtab, sqlite3_index_info *info )
{
    return SQLITE_OK;
}
```

Given how simple the module is, and the fact that it will never return more than 30 rows (there is an internal limit on the number of attached databases), this is a fair trade off between performance and keeping the code simple. Even with fairly large datasets, SQLite does a pretty good job at processing full table scans with surprising speed.

Of course, not all modules—especially internal ones—can get away with this. Most larger modules should try to provide an intelligent response to the optimizer's questions. To see how this is done, we'll take a more in-depth look at this function later on in the chapter. See [“Best Index and Filter” on page 262](#).

## Custom Functions

As much as possible, a good module will attempt to make virtual table instances look and act exactly like standard tables. Functions like `xBestIndex()` help enforce that abstraction, so that virtual tables can interact with the optimizer to correctly produce more efficient lookups—especially in the case of an internal module trying to provide a better or faster indexing method.

There are a few other cases when SQLite needs a bit of help to hide the virtual table abstraction from the database user and other parts of the SQLite engine. SQL function calls and expression processing is one such area.

The `xFindFunction()` allows a module to override an existing function and provide its own implementation. In most cases, this is not needed (or even recommended). The major exceptions are the SQL functions `like()` and `match()`, which are used to implement the SQL expressions `LIKE` and `MATCH` (see [Appendix D](#) for more details).

A text-search engine is likely to override the `like()` and `match()` functions to provide an implementation that can directly access the search string and base its index optimization off the provided arguments. Without the ability to override these functions, it would be very difficult to optimize text searches, as the standard algorithm would require a full stable scan, extracting each row value and doing an external comparison.

```
int xFindFunction( sqlite3_vtab *vtab, int arg, const char *func_name,
                  custom_function_ref, void **udp_ref)
```

Optional. This function allows a module to override an existing function. It is called when preparing an SQL statement that uses a virtual table column as the first parameter in an SQL function (or the second, in the case of `like()`, `glob()`, `match()`, or `regexp()`). The first parameter is the `vtab` structure for this table instance. The second parameter indicates how many parameters are being passed to the SQL function, and the third parameter holds the name of the function. The fourth parameter is a reference to a scalar function pointer (see “[Scalar Functions](#)” on page 182), and the fifth parameter is a reference to a user-data pointer.

Using data from the first three parameters, a virtual table module needs to decide if it wants to override the existing function or not. If the module does not want to override the function, it should simply return zero. If the module does want to provide a custom function, it needs to set the function pointer reference (the fourth parameter) to the scalar function pointer of its choice and set the user-data pointer reference to a user-data pointer. The new function (and user-data pointer) will be called in the same context as the original function.

Most modules will not need to implement this function, and those that do should only need to override a few key functions. The `dblist` module does not provide an implementation.

## Table Rename

Many modules, especially internal modules, key specific information off the name of the virtual table. This means that if the name of the virtual table is changed, the module needs to update any references to that name. This is done with the `xRename()` function.

```
int xRename( sqlite3_vtab *vtab, const char *new_name )
```

Required. This function is called in response to the SQL command `ALTER TABLE...RENAME`. The first parameter is the table instance being renamed, and the second parameter is the new table name.

In the case of an internal module, the most likely course of action is to rename any shadow tables to match the new name. Doing this properly will require knowing the original table name, as well as the database (`main`, `temp`, etc.), that was passed into `xCreate()` or `xConnect()`.

In the case of an external module, this function can usually just return `SQLITE_OK`, unless the table name has significance to some external data mapping.

As with any virtual table function that deals with table names, the module needs to properly qualify any SQL operation with a full database and table name, both properly quoted.

The `dblist` module has a very short `xRename()` function:

```
static int dblist_rename( sqlite3_vtab *vtab, const char *newname )
{
    return SQLITE_OK;
}
```

The `dblist` module does not use the table name for anything, so it can safely do nothing.

## Opening and Closing Table Cursors

We will now look at the process of scanning a table and retrieving the rows and column values from the virtual table. This is done by opening a table cursor. The cursor holds all the state data required for the table scan, including SQL statements, file handles, and other data structures. After the cursor is created, it is used to step over each row in the virtual table and extract any required column values. When the module indicates that no more rows are available, the cursor is either reset or released. Virtual table cursors can only move forward through the rows of a table, but they can be reset back to the beginning for a new table scan.

A cursor is created using the `xOpen()` function and released with the `xClose()` function. Like the `vtab` structure, it is the responsibility of the module to allocate an `sqlite3_vtab_cursor` structure and return it back to the SQLite engine.

```
int xOpen( sqlite3_vtab *vtab, sqlite3_vtab_cursor **cursor )
```

Required. This function must allocate, initialize, and return a cursor.

```
int xClose( sqlite3_vtab_cursor *cursor )
```

Required. This function must clean up and release the cursor structure. Basically, it should undo everything done by `xOpen()`.

The native `sqlite3_vtab_cursor` structure is fairly minimal, and looks like this:

```
struct sqlite3_vtab_cursor {
    sqlite3_vtab *pVtab; /* pointer to table instance */
};
```

As with the `sqlite3_vtab` structure, a module is expected to extend this structure with whatever data the module requires. The custom `dblist` cursor looks like this:

```
typedef struct dblist_cursor_s {
    sqlite3_vtab_cursor cur; /* this must go first */
    sqlite3_stmt *stmt; /* PRAGMA database_list statement */
    int eof; /* EOF flag */
} dblist_cursor;
```

For the `dblist` module, the only cursor-specific data that is needed is an SQLite statement pointer and an EOF flag. The flag is used to indicate when the module has reached the end of the `PRAGMA database_list` output.

Outside of allocating the `dblist_cursor`, the only other task the `dblist xOpen()` function needs to do is prepare the `PRAGMA SQL` statement:

```
static int dblist_open( sqlite3_vtab *vtab, sqlite3_vtab_cursor **cur )
{
    dblist_vtab    *v = (dblist_vtab*)vtab;
    dblist_cursor  *c = NULL;
    int            rc = 0;

    c = sqlite3_malloc( sizeof( dblist_cursor ) );
    *cur = (sqlite3_vtab_cursor*)c;
    if ( c == NULL ) return SQLITE_NOMEM;

    rc = sqlite3_prepare_v2( v->db, "PRAGMA database_list", -1, &c->stmt, NULL );
    if ( rc != SQLITE_OK ) {
        *cur = NULL;
        sqlite3_free( c );
        return rc;
    }
    return SQLITE_OK;
}
```

As with `xCreate()` and `xConnect()`, no `sqlite3_vtab_cursor` should be allocated or passed back unless an `SQLITE_OK` is returned. There is no need to initialize the `pVtab` field of the cursor—SQLite will take care of that for us.

The `dblist` version of `xClose()` is very simple. The module must make sure the prepared statement is finalized before releasing the cursor structure:

```
static int dblist_close( sqlite3_vtab_cursor *cur )
{
    sqlite3_finalize( ((dblist_cursor*)cur)->stmt );
    sqlite3_free( cur );
    return SQLITE_OK;
}
```

You may be wondering why the module puts the statement pointer into the cursor. This requires the module to reprepare the `PRAGMA` statement for each cursor. Wouldn't it make more sense to put the statement pointer in the `vtab` structure? That way it could be prepared only once, and then reused for each cursor.

At first, that looks like an attractive option. It would be more efficient and, in most cases, work just fine—right up to the point where SQLite needs to create more than one cursor on the same table instance at the same time. Since the module depends on the statement structure to keep track of the position in the virtual table data (that is, the output of `PRAGMA database_list`), the module design needs each cursor to have its own statement. The easiest way to do this is simply to prepare and store the statement with the cursor, binding the statement lifetime to the cursor lifetime.



## Filtering Rows

The `xFilter()` function works in conjunction with the `xBestIndex()` function, providing the SQLite query engine a means to communicate any specific constraints or conditions put on the query. The `xBestIndex()` function is used by the query optimizer to ask the module questions about different lookup patterns or limits. Once SQLite decides what to do, the `xFilter()` function is used to tell the module which plan of action is being taken for this particular scan.

```
int xFilter( sqlite3_vtab_cursor *cursor,
            int idx_num, const char *idx_str,
            int argc, sqlite3_value **argv )
```

Required. This function is used to reset a cursor and initiate a new table scan. SQLite will communicate any constraints that have been placed on the current cursor. The module may choose to skip over any rows that do not meet these constraints. All of the parameters are determined by actions taken by the `xBestIndex()` function. The first row of data must also be fetched.

The idea is to allow the module to “pre-filter” as many rows as it can. Each time the SQLite library asks the module to advanced the table cursor to the next row, the module can use the information provided to the `xFilter()` function to skip over any rows that do not meet the stated criteria for this table scan.

The `xBestIndex()` and `xFilter()` functions can also work together to specify a specific row ordering. Normally, SQLite makes no assumptions about the order of the rows returned by a virtual table, but `xBestIndex()` can be used indicate the ability to support one or more specific orderings. If one of those orderings is passed into `xFilter()`, the table is required to return rows in the specified order.

To get any use out of the `xFilter()` function, a module must also have a fully implemented `xBestIndex()` function. The `xBestIndex()` function sets up the data that is passed to the `xFilter()` function. Most of the data passed into `xFilter()` has no specific meaning to SQLite, it is simply based off code agreements between `xBestIndex()` and `xFilter()`.

Implementing all this can be quite cumbersome. Thankfully, as with `xBestIndex()`, it is perfectly valid for a module to ignore the filtering system. If a user query applies a set of conditions on the rows it wants returned from a virtual table, but the module does not filter those out, the SQLite engine will be sure to do it for us. This greatly simplifies the module code, but with the trade-off that any operation against that module turns into a full table scan.

Full table scans may be acceptable for many types of external modules, but if you’re developing a customized index system, you have little choice but to tackle writing robust `xBestIndex()` and `xFilter()` functions. To get a better idea on how to do this, see [“Best Index and Filter” on page 262](#).

Even if the actual filtering process is ignored, the `xFilter()` function is still required to do two important tasks. First, it must reset the cursor and prepare it for a new table scan. Second, `xFilter()` is responsible for fetching the first row of output data. Since the `dblist` module doesn't utilize the filtering system, these are pretty much the only things the `xFilter()` function ends up doing:

```
static int dblist_filter( sqlite3_vtab_cursor *cur,
                        int idxnum, const char *idxstr,
                        int argc, sqlite3_value **value )
{
    dblist_cursor *c = (dblist_cursor*)cur;
    int rc = 0;

    rc = sqlite3_reset( c->stmt );    /* start a new scan */
    if ( rc != SQLITE_OK ) return rc;
    c->eof = 0;                       /* clear EOF flag */

    dblist_get_row( c );              /* fetch first row */
    return SQLITE_OK;
}
```

Although the `dblist` module does not utilize the `xBestIndex()` data, there are still important things to do. The `xFilter()` function must first reset the statement. This “rewinds” the pragma statement, putting our cursor at the head of the table. There are situations where `sqlite3_reset()` may be called on a freshly prepared (or freshly reset) statement, but that is not a problem. There are other calling sequences which may require `xFilter()` to reset the statement.

Because both `xFilter()` and the `xNext()` function (which we'll look at next) need to fetch row data, we've broken that out into its own function:

```
static int dblist_get_row( dblist_cursor *c )
{
    int rc;

    if ( c->eof ) return SQLITE_OK;
    rc = sqlite3_step( c->stmt );
    if ( rc == SQLITE_ROW ) return SQLITE_OK;    /* we have a valid row */

    sqlite3_reset( c->stmt );
    c->eof = 1;
    return ( rc == SQLITE_DONE ? SQLITE_OK : rc ); /* DONE -> OK */
}
```

The main thing this function does is call `sqlite3_step()` on the cursor's SQL statement. If the module gets a valid row of data (`SQLITE_ROW`), everything is good. If the module gets anything else (including `SQLITE_DONE`) it considers the scan done. In that case, the module resets the statement before returning `SQLITE_OK` (if it got to the end of the table) or the error. Although the module could wait for `xFilter()` to reset the statement or `xClose()` to finalize it, it is best to reset the statement as soon as we know we've reached the end of the available data.

## Extracting and Returning Data

We now, finally, get to the core of any virtual table implementation. Once the module has a valid cursor, it needs to be able to advanced that cursor over the virtual table data and return column values. This core set of four functions is used to do just that:

```
int xNext( sqlite3_vtab_cursor *cursor )
```

Required. This function is used to advance the cursor to the next row. When the SQLite engine no longer needs data from the current row, this is called to advance the virtual table scan to the next row. If a virtual table is already on the last row of the table when `xNext()` is called, it should *not* return an error.

Note that `xNext()` truly is a “next” function and not a “get row” function. It is not called to fetch the first row of data. The first row of data should be fetched and made available by the `xFilter()` function.

If the module is filtering rows via `xBestIndex()` and `xFilter()`, it is legitimate for `xNext()` to skip over any rows in the virtual table that do not meet the conditions put forth to `xFilter()`. Additionally, if `xBestIndex()` indicated an ability to return the data in a specific order, `xNext()` is obligated to do so. Otherwise, `xNext()` may return rows in any order it wishes, so long as they are all returned.

```
int xEOF( sqlite3_vtab_cursor *cursor )
```

Required. This function is used to determine if the virtual table has reached the end of the table. Every call to `xFilter()` and `xNext()` will immediately be followed by a call to `xEOF()`. If the previous call to `xNext()` advanced the cursor past the end of the table, `xEOF()` should return a true (nonzero) value, indicating that the end of the table has been reached. If the cursor still points to a valid table row, `xEOF()` should return false (zero).

`xEOF()` is also called right after `xFilter()`. If a table is empty or will return no rows under the conditions defined by `xFilter()`, then `xEOF()` needs to return true at this time.

There is no guarantee `xNext()` will keep being called until `xEOF()` returns true. The query may decide to terminate the table scan at any time.

```
int xRowid( sqlite3_vtab_cursor *cursor, sqlite_int64 *rowid )
```

Required. This function is used to retrieve the ROWID value of the current row. The ROWID value should be passed back through the `rowid` reference provided as the second parameter.

```
int xColumn( sqlite3_vtab_cursor *cursor, sqlite3_context *ctx, int cid )
```

Required. This function is used to extract column values from the cursor’s current row. The parameters include the virtual table cursor, an `sqlite3_context` structure, and a column index. Values should be returned using the `sqlite3_context` and the `sqlite3_result_xxx()` functions. The column index is zero-based, so the first column defined in the virtual table definition will have a column index of zero. This function is typically called multiple times between calls to `xNext()`.

The first two functions, `xNext()` and `xEof()`, are used to advance a cursor through the virtual table data. A cursor can only be advanced through the data, it cannot be asked to back up, save for a full reset back to the beginning of the table. Unless `xBestIndex()` and `xFilter()` agreed on a specific filtering or ordering, `xNext()` is under no obligation to present the data in a specific order. The only requirement is that continuous calls to `xNext()` will eventually visit each row exactly once.

At each row, `xRowid()` and `xColumn()` can be used to extract values from the current row. `xRowid()` is used to extract the virtual ROWID value, while `xColumn()` is used to extract values from all the other columns. While a cursor is at a specific row, the `xRowid()` and `xColumn()` functions may be called any number of times in any order.

Since the `dblist` module depends on executing the `PRAGMA` statement to return data, most of these functions are extremely simple. For example, the `dblist xNext()` function calls the `dblist_get_row()` function, which in turn calls `sqlite3_step()` on the cursor's statement:

```
static int dblist_next( sqlite3_vtab_cursor *cur )
{
    return dblist_get_row( (dblist_cursor*)cur );
}
```

The `dblist xEof()` function returns the cursor EOF flag. This flag is set by `dblist_get_row()` when the module reaches the end of the `PRAGMA database_list` data. The flag is simply returned:

```
static int dblist_eof( sqlite3_vtab_cursor *cur )
{
    return ((dblist_cursor*)cur)->eof;
}
```

The data extraction functions for the `dblist` module are also extremely simple. The `dblist` module uses the `seq` column from the `PRAGMA database_list` output as its virtual ROWID. This means that it can return the value of the `seq` column as our ROWID. As it happens, the `seq` column is the first column, so it has an index of zero:

```
static int dblist_rowid( sqlite3_vtab_cursor *cur, sqlite3_int64 *rowid )
{
    *rowid = sqlite3_column_int64( ((dblist_cursor*)cur)->stmt, 0 );
    return SQLITE_OK;
}
```

The `xColumn()` function is nearly as simple. Since there is a one-to-one mapping between the output columns of the `PRAGMA` statement and the `dblist` virtual table columns, the module can extract values directly from the `PRAGMA` output and pass them back as column values for our virtual table:

```
static int dblist_column( sqlite3_vtab_cursor *cur, sqlite3_context *ctx, int cidx )
{
    dblist_cursor *c = (dblist_cursor*)cur;
    sqlite3_result_value( ctx, sqlite3_column_value( c->stmt, cidx ) );
}
```

```
    return SQLITE_OK;
}
```

In most cases, these functions would be considerably more complex than what the `dblist` module has here. The fact that the `dblist` module depends on only a single SQL command to return all of the required data makes the design of these functions quite simple—even more so, since the output of the SQL command exactly matches the data format we need.

To get a better idea of what a more typical module might look like, have a look at the implementation of these functions in the other example module ([“Advanced Example: weblog Module” on page 246](#)).

## Virtual Table Modifications

As with any other table, modules support the ability to make modifications to a virtual table using the standard `INSERT`, `UPDATE`, and `DELETE` commands. All three operations are supported by the `xUpdate()` function. This is a table-level function that operates on a table instance, not a cursor.

```
int xUpdate( sqlite3_vtab *vtab,
            int argc, sqlite3_value **argv,
            sqlite_int64 *rowid )
```

Optional. This call is used to support all virtual table modifications. It will be called in response to any `INSERT`, `UPDATE`, or `DELETE` command. The first parameter is the table instance. The second and third parameters pass in a series of database values. The fourth parameter is a reference to a `ROWID` value, and is used to pass back the newly defined `ROWID` when a new row is inserted.

The `argv` parameter will have a valid `sqlite3_value` structure for each argument, although some of those values may have the type `SQLITE_NULL`. Rows are always inserted or updated as whole sets. Even if the SQL `UPDATE` command only updates a single column of a row, the `xUpdate()` command will always be provided with a value for every column in a row.

If only a single argument is provided, this is a `DELETE` request. The sole argument (`argv[0]`) will be an `SQLITE_INTEGER` that holds the `ROWID` of the row that needs to be deleted.

In all other cases, exactly  $n+2$  arguments will be provided, where  $n$  is the number of columns, including `HIDDEN` ones (see [“Create and Connect” on page 248](#)) in the table definition. The first argument (`argv[0]`) is used to refer to existing `ROWID` values, while the second (`argv[1]`) is used to refer to new `ROWID` values. These two arguments will be followed by a value for each column in a row, starting with `argv[2]`. Essentially, the arguments `argv[1]` through `argv[n+1]` represent a whole set of row values starting with the implied `ROWID` column followed by all of the declared columns.

If `argv[0]` has the type `SQLITE_NULL`, this is an `INSERT` request. If the `INSERT` statement provided an explicit `ROWID` value, that value will be in `argv[1]` as an `SQLITE_INTEGER`. The module should verify the `ROWID` is appropriate and unique before using it. If no explicit `ROWID` value was given, `argv[1]` will have a type of `SQLITE_NULL`. In this case, the module should assign an unused `ROWID` value and pass it back via the `rowid` reference pointer in the `xUpdate()` parameters.

If `argv[0]` has the type `SQLITE_INTEGER`, this is an `UPDATE`. In this case, both `argv[0]` and `argv[1]` will be `SQLITE_INTEGER` types with `ROWID` values. The existing row indicated in `argv[0]` should be updated with the values supplied in `argv[1]` through `argv[n+1]`. In most cases, `argv[0]` will be the same as `argv[1]`, indicating no change in the `ROWID` value. However, if the `UPDATE` statement includes an explicit update to the `ROWID` column, it may be the case that the first two arguments do not match. In that case, the row indicated by `argv[0]` should have its `ROWID` value changed to `argv[1]`. In either case, all the other columns should be updated with the additional arguments.

It is the module's responsibility to enforce any constraints or typing requirements on the incoming data. If the data is invalid or otherwise cannot be inserted or updated into the virtual table, `xUpdate()` should return an appropriate error, such as `SQLITE_CONSTRAINT` (constraint violation).

There may be times when a modification (including a `DELETE`) happens while an active cursor is positioned at the row in question. The module design must be able to handle this situation.

The `xUpdate()` function is optional. If no implementation is provided, all virtual table instances provided by this module will be read-only. That is the case with our `dblist` module, so there is no implementation for `xUpdate()`.

## Cursor Sequence

Most cursor functions have very specific tasks. Some of these, like `xEOF()`, are typically very small, while others, like `xNext()`, can be quite complex. Regardless of size or complexity, they all need to work together to perform the proper tasks and maintain the state of the `sqlite3_vtab_cursor` structure, including any extensions your module might require.

In order to maintain the proper state, it is important to understand which functions can be called, and when. [Figure 10-1](#) provides a sequence map of when cursor functions can be called. Your module needs to be prepared to properly deal with any of these transitions.

Some of the call sequences can catch people by surprise, such as having `xClose()` called before `xEOF()` returns true. This might happen if an SQL query has a `LIMIT` clause. Also, it is possible for `xRowid()` to be called multiple times between calls to `xNext()`. Similarly, `xColumn()` may be called multiple times with the same column index between calls to

`xNext()`. It is also possible that neither `xRowid()` nor `xColumn()` (nor both) may be called at all between calls to `xNext()`.

In addition to cursor functions, some table-level functions may also be called throughout this sequence. In specific, `xUpdate()` may be called at any time, possibly altering the row a cursor is currently processing. Generally, this happens by having an update statement open a cursor, find the row it is looking to modify, and then call `xUpdate()` outside of the cursor context.

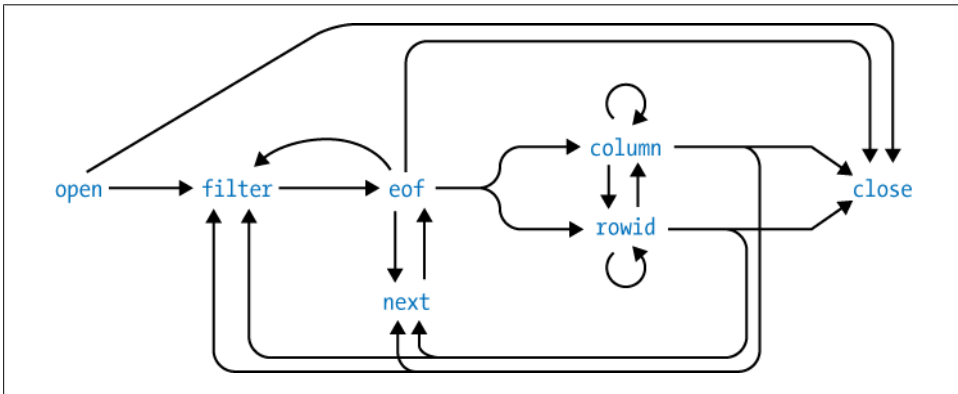

Figure 10-1. The lifespan of a virtual table cursor. This shows the possible calling sequences for the cursor functions of a virtual table module.

It can be tricky to test your module and confirm that everything is working properly. The only advice I can offer is to test your module with a known and relatively small set of data, running it through as many query types as possible. Try to include different variations of `GROUP BY`, `ORDER BY`, and any number of join operations (including self-joins). When you're first starting to write a module, it might also help to put simple `printf()` or other debug statements at the top of each function. This will assist in understanding the call patterns.

## Transaction Control

Like any other database element, virtual tables are expected to be aware of database transactions and support them appropriately. This is done through four optional functions. These functions are table-level functions, not cursor-level functions.

`int xBegin( sqlite3_vtab *vtab )`

Optional. Indicates the start of a transaction involving the virtual table. Any return code other than `SQLITE_OK` will cause the transaction to fail.

`int xSync( sqlite3_vtab *vtab )`

Optional. Indicates the start of a transactional commit that involves the virtual table. Any return code other than `SQLITE_OK` will cause the whole transaction to automatically be rolled back.

```
int xCommit( sqlite3_vtab *vtab )
```

Optional. Indicates the finalization of a transactional commit that involves the virtual table. The return code is ignored—if `xSync()` succeeded, this function must succeed.

```
int xRollback( sqlite3_vtab *vtab )
```

Optional. Indicates that a transaction involving the virtual table is being rolled back. The module should revert its state to whatever state it was in prior to the call to `xBegin()`. The return code is ignored.

These functions are optional and are normally only required by external modules that provide write capabilities to external data sources. Internal modules that record their data into standard tables are covered by the existing transaction engine (which will automatically begin, commit, or roll back under the control of the user SQL session). Modules that are limited to read-only functionality do not need transactional control, since they are not making any modifications.



Internal modules (modules that store all their data in shadow database tables) do *not* need to implement transaction control functions. The existing, built-in transaction system will automatically be applied to any changes made to standard database tables.

If you do need to support your own transactions, it is important to keep the program flow in mind. `xBegin()` will always be the first function to be called.\* Typically, there will be calls to `xUpdate()` followed by a two-step sequence of calls to `xSync()` and `xCommit()` to close and commit the transaction. Once `xBegin()` has been called, it is also possible to get a call to `xRollback()` to roll the transaction back. The `xRollback()` function can also be called after `xSync()` (but before `xCommit()`) if the sync step fails.

Full transactions do not nest, and virtual tables do not support save-points. Once a call to `xBegin()` has been made, you will not get another one until either `xCommit()` or `xRollback()` has been called.

In keeping with the ACID properties of a transaction, any modifications made between calls to `xBegin()` and `xSync()` should only be visible to this virtual table instance in this database connection (that is, this `vtab` structure). This can be done by delaying any writes or modifications to external data sources until the `xSync()` function is called, or by somehow locking the data source to ensure other module instances (or other applications) cannot modify or access the data. If the data is written out in `xSync()`, the data source still needs to be locked until a call to `xCommit()` or `xRollback()` is made. If `xSync()` returns `SQLITE_OK`, it is assumed that any call to `xCommit()` will succeed, so you want to try to make your modifications in `xSync()` and verify and release them in `xCommit()`.

\* In theory. Currently, calls are made directly to `xSync()` and `xCommit()` following the call to `xCreate()`. It isn't clear if this is considered a bug or not, so this behavior may change in future versions of SQLite.



Proper transactional control is extremely hard, and making your transactions fully atomic, consistent, isolated, and durable is no small task. Most external modules that attempt to implement transactions do so by locking the external data source. You still need to support some type of rollback ability, but exclusive access eliminates any isolation concerns.

Since the `dblist` module is read-only, it does not need to provide any transactional functions.

## Register the Module

Now that we've had a look at all the functions required to define a module, we need to register them. As we've already seen, this is done with the `sqlite3_create_module()` function. To register the module, we need to fill out an `sqlite3_module` structure and pass that to the create function.

You may have noticed that all of our module functions were marked static. This is because the module was written as an extension (see the section [“SQLite Extensions” on page 204](#)). By structuring the code that way, we can easily build our virtual table module into an application, or we can create a dynamic extension.

Here is the initialization function for our extension:

```
static sqlite3_module dblist_mod = {
    1,                /* iVersion      */
    dblist_connect,   /* xCreate()     */
    dblist_connect,   /* xConnect()    */
    dblist_bestindex, /* xBestIndex()  */
    dblist_disconnect, /* xDisconnect() */
    dblist_disconnect, /* xDestroy()    */
    dblist_open,      /* xOpen()       */
    dblist_close,     /* xClose()      */
    dblist_filter,    /* xFilter()     */
    dblist_next,      /* xNext()       */
    dblist_eof,       /* xEOF()        */
    dblist_column,    /* xColumn()     */
    dblist_rowid,     /* xRowid()      */
    NULL,             /* xUpdate()     */
    NULL,             /* xBegin()      */
    NULL,             /* xSync()       */
    NULL,             /* xCommit()     */
    NULL,             /* xRollback()   */
    NULL,             /* xFindFunction() */
    dblist_rename     /* xRename()     */
};

int dblist_init( sqlite3 *db, char **error, const sqlite3_api_routines *api )
{
    int rc;
    SQLITE_EXTENSION_INIT2(api);
```

```

/* register module */
rc = sqlite3_create_module( db, "dblist", &dblist_mod, NULL );
if ( rc != SQLITE_OK ) {
    return rc;
}

/* automatically create an instance of the virtual table */
rc = sqlite3_exec( db,
    "CREATE VIRTUAL TABLE temp.sql_database_list USING dblist",
    NULL, NULL, NULL );
return rc;
}

```

The most important thing to notice is that the `sqlite3_module` structure is given a static allocation. The SQLite library does not make a copy of this structure when the module is registered, so the `sqlite3_module` structure must remain valid for the duration of the database connection. In this case, we use a file-level global that is statically initialized with all the correct values.

The extension entry point function is a bit unique, in that it not only defines the module, but it also goes ahead and creates an instance of a `dblist` virtual table. Normally, an extension initialization function wouldn't (and shouldn't) do something like this, but in this case it makes sense. Like any other table, virtual tables are typically bound to a specific database. But the active database list we get from the `PRAGMA database_list` command is a function of the current state of the database connection (and all attached databases), and isn't really specific to a single database. If you were to create a `dblist` table in multiple databases that were all attached to the same database connection, they would all return the same data. It is the database connection (and not a specific database) that is the real source of the data.

So, in the somewhat unique case of the `dblist` module, we only need one instance of the virtual table per database connection. Ideally, it would always be there, no matter which databases are attached. It would also be best if the table wasn't "left behind" in a database file after that database was closed or detached. Not only would this tie the database file to our module, it is also unnecessary since a `dblist` table instance doesn't have any state beyond the database connection.

To meet all these needs, the module goes ahead and just makes a single instance of the table in the temporary database. Every database connection has a temporary database, and it is always named `temp`. This makes the table instance easy to find. Creating it in the `temp` database also keeps the table instance out of any "real" database files, and ties the lifetime of the table to the lifetime of the database connection. All in all, it is a perfect, though somewhat unusual, fit for this specific module.

The end result is that if you load the `dblist` extension, it will not only register the `dblist` module, it will also create an instance of the `dblist` virtual table at `temp.sql_database_list`. System tables in SQLite have the prefix `sqlite_`, but those names are reserved and the extension cannot create a table with that prefix. The name `sql_database_list` gets the idea across, however.

## Example Usage

After all that work, what do we get? First, let's have a look at what the `PRAGMA database_list` does by itself. Here is some example output:

```
sqlite> PRAGMA database_list;
seq      name      file
-----
0        main      /Users/jak/sqlite/db1.sqlite3
1        temp
2        memory
3        two       /Users/jak/sqlite/db2.sqlite3
```

In this case, I ran the `sqlite3` utility with the file `db1.sqlite3`, created an empty temporary table (so the `temp` database shows up), attached an in-memory database as `memory`, and finally attached a second database file as `two`.

Now let's load our module extension and see what we get:

```
sqlite> .load dblist.sqlite3ext dblist_init
sqlite> SELECT * FROM sqlite3_database_list;
seq      name      file
-----
0        main      /Users/jak/sqlite/db1.sqlite3
1        temp
2        memory
3        two       /Users/jak/sqlite/db2.sqlite3
```

And we get...the exact same thing! Actually, that's a good thing—that was the whole point. The key thing is that, unlike the `PRAGMA` command, we can do this:

```
sqlite> SELECT * FROM sqlite3_database_list WHERE file == '';
seq      name      file
-----
1        temp
2        memory
```

This shows us all of the databases that have no associated filename. You'll note that `PRAGMA database_list` (and hence the `dblist` module) returns an empty string, and not a `NULL`, for a database that does not have an associated database file.

Perhaps most useful, we can also make queries like this to figure out what the logical database name is for a particular database file:

```
sqlite> SELECT name FROM sqlite3_database_list
...> WHERE file LIKE '%db2.sqlite3';
name
-----
two
```

I'd be the first to admit this isn't exactly ground-breaking work. Parsing the direct output of `PRAGMA database_list` isn't that big of a deal—for a program or for a human. The main point of this example wasn't to show the full power of virtual tables, but to give us a problem to work with where we could focus on the functions and interface

required by the virtual table system, rather than focusing on the complex code required to implement it.

Now that you've seen the module interface and have a basic idea of how things work, we're going to shift our focus to something a bit more practical, and a bit more complex.

## Advanced Example: weblog Module

Now that we've seen a very simple example of a virtual table module, you should have some idea of how they work. Although our `dblist` module was a good introduction to how virtual tables operate, it isn't a very representative example.

To provide a more advanced and realistic example, we're going to look at a second example module. This module is known as *weblog*, and is designed to parse Apache *httpd* server logs and present them to the database engine as a virtual table. It will parse the default Apache *combine* or *common* logfile formats, or any other logfile that matches this format. Apache logfiles are cross-platform and reasonably common. Many people have access to logfiles with a decent amount of interesting data, allowing this example to be a bit more hands-on.

Be warned that some of the code explanations will be a bit brief. Although the functions are larger, much of the code involves rather basic housekeeping-type tasks, such as string scanning. Rather than focus on these parts, most of the descriptions will focus on how the code interacts with the SQLite library. Many of the housekeeping details will be, as they say, left as an exercise for the reader.

The weblog module is designed as an external read-only module. The module gets all of its data directly from a web server logfile, making it dependent on external resources to provide data. The module does not let you modify those data sources, however.

A weblog virtual table would be created with an SQL command like this:

```
CREATE VIRTUAL TABLE current USING weblog( /var/log/httpd/access.log );
```

Notice that the filename has no single quotes and is not a string literal. Table parameters include everything between the commas (of which we have none, since there is only one argument), so if you need to reference a file with spaces, you can do something like this:

```
CREATE VIRTUAL TABLE log USING weblog( /var/log/httpd/access log file.txt );
```

The first example will create a table instance `current`, and bind it to the data found in the `/var/log/httpd/access.log` file. The second example will bind the SQL table `log` to the file `access log file.txt` in the same directory.

Briefly, the Apache *common* log format contains seven fields. The first field is the IP address of the client. In rare situations this might be a hostname, but most servers are configured to simply record the IP address in dot-decimal format. The second field is a legacy ident field. Most web servers do not support this, and record only a single dash.

The third field records the username, if given. If not given, this field is also recorded as a single dash. The fourth field is a timestamp, surrounded by square brackets ( [ ] ). The fifth is the first line of the HTTP request, in double quotes. This contains the HTTP operation (such as GET or POST) as well as the URL. In the sixth column is the HTTP result code (e.g., 200 for OK, 404 for missing resource), with the number of payload bytes returned in the seventh field.

The *combine* file format adds two more fields. The eighth field is the referrer header, which contains a URL. The ninth field is the user-agent header, also in double quotes.

Count	Logfile field	Meaning
1	Client Address	IP or hostname of HTTP client
2	Ident	Legacy field, not used
3	Username	Client-provided username
4	Timestamp	Time of transaction
5	HTTP Request	HTTP operation and URL
6	Result Code	Result status of HTTP request
7	Bytes	Payload bytes
8	Referrer	URL of referrer page
9	User Agent	Client software identifier

The weblog module is designed to read the *combine* file format. However, if given a *common* logfile that lacks the last two fields, these extra fields will simply be NULL.

Although the logfile has seven or nine columns, the weblog virtual table will have more than nine columns. The virtual table adds a number of additional columns that present the same data in different ways.

For example, the IP address will be returned in one column as a text value that holds the traditional dotted notation. Another column will provide a raw integer representation. The text column is easier for humans to understand, but the integer column allows for faster searches, especially over ranges. The underlying data is the same: the two columns just return the data in different formats. Similarly, the timestamp column can return the string value from the logfile, or it can return separate integer values for the year, month, day, etc.

If this were a fully supported SQLite extension, it would likely include more than just the weblog module. Ideally, it would also include a number of utility functions, such as a function that converted text values containing dot-decimal IP addresses to and from integer values. (Then again, if this were a fully supported module, it would include decent error messages and other polish that this example lacks. I'm trying to keep the line counts as small as possible.) Some of these functions would reduce the need for extra columns, since you could just convert the data using SQL, but there are still times when having the extra columns is extremely useful.

## Create and Connect

Since the weblog module is an external module, there isn't any data to initialize. This means that, like the dblist, we can use the same function for both `xCreate()` and `xConnect()`.

Before we get into the function, let's have a quick look at our augmented vtab structure. Since this module does not use the table name for anything, the only data we need to keep around is the logfile filename:

```
typedef struct weblog_vtab_s {
    sqlite3_vtab  vtab;
    char         *filename;
} weblog_vtab;
```

The weblog create/connect function is a bit longer than the dblist version, but still fairly easy to follow. First, it verifies that we have exactly four arguments. Remember that the first three arguments are always the module name, the database name, and the table name. The fourth argument is the first user-provided argument, which in this case is the log filename. The function tries to open that file for read-only access, just to verify the file is there and can be opened it for reading. This test isn't foolproof, but it is a nice check. The module then allocates the vtab structure, stashes a copy of the filename, and declares the table definition:

```
static int weblog_connect( sqlite3 *db, void *udp, int argc,
                          const char *const *argv, sqlite3_vtab **vtab, char **errmsg )
{
    weblog_vtab  *v = NULL;
    const char   *filename = argv[3];
    FILE         *ftest;

    if ( argc != 4 ) return SQLITE_ERROR;

    *vtab = NULL;
    *errmsg = NULL;

    /* test to see if filename is valid */
    ftest = fopen( filename, "r" );
    if ( ftest == NULL ) return SQLITE_ERROR;
    fclose( ftest );

    /* allocate structure and set data */
    v = sqlite3_malloc( sizeof( weblog_vtab ) );
    if ( v == NULL ) return SQLITE_NOMEM;
    ((sqlite3_vtab*)v)->zErrMsg = NULL; /* need to init this */

    v->filename = sqlite3_mprintf( "%s", filename );
    if ( v->filename == NULL ) {
        sqlite3_free( v );
        return SQLITE_NOMEM;
    }
    v->db = db;
```

```

sqlite3_declare_vtab( db, weblog_sql );
*vtab = (sqlite3_vtab*)v;
return SQLITE_OK;
}

```

The table definition contains 20 columns total. The first 9 map directly to the fields within the logfile, while the extra 11 columns provide different representations of the same data. The last column represents the whole line of the logfile, without modifications:

```

const static char *weblog_sql =
"    CREATE TABLE weblog (
"        ip_str      TEXT,          /* 0 */
"        login       TEXT HIDDEN,   /* 1 */
"        user        TEXT,          /* 2 */
"        time_str    TEXT,          /* 3 */
"        req         TEXT,          /* 4 */
"        result      INTEGER,       /* 5 */
"        bytes       INTEGER,       /* 6 */
"        ref         TEXT,          /* 7 */
"        agent       TEXT,          /* 8 */
#define TABLE_COLS_SCAN          9
"        ip_int      INTEGER,       /* 9 */
"        time_day     INTEGER,       /* 10 */
"        time_mon_s   TEXT,          /* 11 */
"        time_mon     INTEGER,       /* 12 */
"        time_year    INTEGER,       /* 13 */
"        time_hour    INTEGER,       /* 14 */
"        time_min     INTEGER,       /* 15 */
"        time_sec     INTEGER,       /* 16 */
"        req_op       TEXT,          /* 17 */
"        req_url      TEXT,          /* 18 */
"        line        TEXT HIDDEN    /* 19 */
"    );
#define TABLE_COLS                20

```

You may have noticed a few of the columns have the keyword `HIDDEN`. This keyword is only valid for virtual table definitions. Any column marked `HIDDEN` will not be returned by `SELECT * FROM...` style queries. You can explicitly request the column, but it is not returned by default. This is very similar in behavior to the `ROWID` column found in standard tables. In our case, we've marked the `login` and `line` columns as `HIDDEN`. The `login` column almost never contains valid data, while the `line` column is redundant (and large). The columns are there if you need them, but in most cases people aren't interested in seeing them. To keep the general output cleaner, I've chosen to hide them.

## Disconnect and Destroy

As with `xConnect()` and `xCreate()`, the `weblog xDisconnect()` and `xDestroy()` functions share the same implementation:

```

static int weblog_disconnect( sqlite3_vtab *vtab )
{
    sqlite3_free( ((weblog_vtab*)vtab)->filename );
    sqlite3_free( vtab );
    return SQLITE_OK;
}

```

Free up the memory used for the filename, free up the memory used by the vtab structure, and return. Simple and easy.

## Other Table Functions

The last set of table-level functions includes `xBestIndex()`, `xFindFunction()`, `xRename()`, and `xUpdate()`, as well as the four transactional functions, `xBegin()`, `xSync()`, `xCommit()`, and `xRollback()`. The `xFindFunction()` is optional, and the weblog module has no use for it, so there is no implementation of this function. Since this is a read-only module, same is true of `xUpdate()`. Similarly, the transactional functions are also optional and not required for read-only modules. For table-level functions, that leaves only `xRename()` and `xBestIndex()`.

The `xRename()` function is required, but since the module makes no use of the virtual table instance name, it is basically a no-op:

```

static int weblog_rename( sqlite3_vtab *vtab, const char *newname )
{
    return SQLITE_OK;
}

```

In the case of the weblog module, once you set the name of the external logfile when creating a virtual table, there is no way to alter it, other than dropping and re-creating the table.

The last function, `xBestIndex()`, is required, but it isn't actually returning any useful data:

```

static int weblog_bestindex( sqlite3_vtab *vtab, sqlite3_index_info *info )
{
    return SQLITE_OK;
}

```

Since the module has no indexing system, it can't offer any optimized search patterns. The logfile is always scanned start to finish anyway, so every query is a full table scan.

## Open and Close

We can now move on to the cursor functions. The first thing to look at is the weblog cursor structure. The weblog cursor is a bit more complex than the dblist example, as it needs to read and scan the data values from the logfile.



There are three basic sections to this structure. The first is the base `sqlite3_vtab_cursor` structure. As always, this must come first, and must be a full instance of the structure:

```
#define LINESIZE 4096

typedef struct weblog_cursor_s {
    sqlite3_vtab_cursor cur;           /* this must be first */

    FILE *fptr;                       /* used to scan file */
    sqlite_int64 row;                 /* current row count (ROWID) */
    int eof;                          /* EOF flag */

    /* per-line info */
    char line[LINESIZE];             /* line buffer */
    int line_len;                    /* length of data in buffer */
    int line_ptrs_valid;             /* flag for scan data */
    char *(line_ptrs[TABLE_COLS]); /* array of pointers */
    int line_size[TABLE_COLS];      /* length of data for each pointer */
} weblog_cursor;
```

The second block deals with the data we need to scan the logfile. The `weblog` module uses the standard C library `f` functions (such as `fopen()`) to open and scan the logfile. Each `weblog` cursor needs a unique `FILE` pointer, just as each `dblist` cursor required a unique statement structure. The module uses the `FILE` structure to keep track of its location within the file, so each cursor needs its own unique `FILE` structure. The cursor needs to keep track of the number of lines it has read from the file, as this value is used as the `ROWID`. Finally, the cursor needs an EOF flag to indicate when it has reached the end of the file.

Having a unique `FILE` pointer for each cursor means the module needs to reopen the file for each table scan. In the case of the `weblog` module, this is actually an advantage, as each table scan will reassociate itself with the correct file. This can be important in a web server environment, where logfiles may roll frequently.

The third section of the `weblog_cursor` structure holds everything the cursor needs to know about the current line. The cursor has a buffer to hold the text and length of the current line. There are also a series of pointers and length counters that are used to scan the line. Since scanning the line is fairly expensive, and must be done all at once, the module delays scanning the line until it's sure the data is needed. Once scanned, the module will keep the scan data around until it reads a new line. To keep track of when a line has been scanned, the cursor contains a "valid" flag.

As we go through the rest of the module functions, you'll see how these fields are used.

You might be thinking that a 4 KB line buffer seems a bit large, but frequently it is not enough. CGI scripts that use extensive query strings can generate very long logfile lines. Another issue is that many referrer URLs, especially those from search engines, can be extremely large. While most lines are only a hundred characters or so, it is best if the

module can try to deal with the longer ones as well. Even with a 4 KB buffer, you'll need to properly deal with potential buffer overflows.

Now that we've seen what the cursor looks like, let's have a look at how it is opened and created. When the module needs to create a new cursor, it will first attempt to open the correct logfile. Assuming that succeeds, it will allocate the cursor structure and initialize the basic data:

```
static int weblog_open( sqlite3_vtab *vtab, sqlite3_vtab_cursor **cur )
{
    weblog_vtab    *v = (weblog_vtab*)vtab;
    weblog_cursor  *c;
    FILE           *fptr;

    *cur = NULL;

    fptr = fopen( v->filename, "r" );
    if ( fptr == NULL ) return SQLITE_ERROR;

    c = sqlite3_malloc( sizeof( weblog_cursor ) );
    if ( c == NULL ) {
        fclose( fptr );
        return SQLITE_NOMEM;
    }

    c->fptr = fptr;
    *cur = (sqlite3_vtab_cursor*)c;
    return SQLITE_OK;
}
```

The open function doesn't need to initialize the line data, as this will all be reset when we read the first line from the data file.

The xClose() function is relatively simple:

```
static int weblog_close( sqlite3_vtab_cursor *cur )
{
    if ( ((weblog_cursor*)cur)->fptr != NULL ) {
        fclose( ((weblog_cursor*)cur)->fptr );
    }
    sqlite3_free( cur );
    return SQLITE_OK;
}
```

Close the file, release the memory.

## Filter

Since the weblog module chooses to ignore the xBestIndex() function, it largely ignores xFilter() as well. The file is reset to the beginning, just to be sure, and the module reads the first line of data:

```

static int weblog_filter( sqlite3_vtab_cursor *cur,
                          int idxnum, const char *idxstr,
                          int argc, sqlite3_value **value )
{
    weblog_cursor *c = (weblog_cursor*)cur;

    fseek( c->fptr, 0, SEEK_SET );
    c->row = 0;
    c->eof = 0;
    return weblog_get_line( (weblog_cursor*)cur );
}

```

The `weblog_get_line()` function reads in a single line from the logfile and copies it into our line buffer. It also verifies that it got a full line. If it didn't get a full line, the function keeps reading (but discards the input) to make sure the file location is left at the beginning of the next valid line. We can reduce how often this happens by making the line buffer bigger, but no matter how big we make the buffer, it is always a good idea to make sure a whole line is consumed, even if the tail is discarded:

```

static int weblog_get_line( weblog_cursor *c )
{
    char *cptr;
    int rc = SQLITE_OK;

    c->row++; /* advance row (line) counter */
    c->line_ptrs_valid = 0; /* reset scan flag */
    cptr = fgets( c->line, LINESIZE, c->fptr );
    if ( cptr == NULL ) { /* found the end of the file/error */
        if ( feof( c->fptr ) ) {
            c->eof = 1;
        } else {
            rc = -1;
        }
        return rc;
    }
    /* find end of buffer and make sure it is the end a line... */
    cptr = c->line + strlen( c->line ) - 1; /* find end of string */
    if ( ( *cptr != '\n' ) && ( *cptr != '\r' ) ) { /* overflow? */
        char buf[1024], *bufptr;
        /* ... if so, keep reading */
        while ( 1 ) {
            bufptr = fgets( buf, sizeof( buf ), c->fptr );
            if ( bufptr == NULL ) { /* found the end of the file/error */
                if ( feof( c->fptr ) ) {
                    c->eof = 1;
                } else {
                    rc = -1;
                }
            }
            break;
        }
        bufptr = &buf[ strlen( buf ) - 1 ];
        if ( ( *bufptr == '\n' ) || ( *bufptr == '\r' ) ) {
            break; /* found the end of this line */
        }
    }
}

```

```

    }
}

while ( ( *cptr == '\n' ) || ( *cptr == '\r' ) ) {
    *cptr-- = '\0'; /* trim new line characters off end of line */
}
c->line_len = ( cptr - c->line ) + 1;
return rc;
}

```

Besides reading a full line, this function also resets the scan flag (to indicate the line buffer has not had the individual fields scanned) and adds one (1) to the line count. At the end, the function also trims off any trailing newline or carriage return characters.

## Rows and Columns

We only have a few functions left. In specific, the module only needs to define the two row-handling functions, `xNext()` and `xEOF()`. We also need the two column functions, `xRowid()` and `xColumn()`.

Three of these four functions are quite simple. The `xNext()` function can call `weblog_get_line()`, just as the `xFilter()` function did. The `xEOF()` and `xRowid()` functions return or pass back values that have already been calculated elsewhere:

```

static int weblog_next( sqlite3_vtab_cursor *cur )
{
    return weblog_get_line( (weblog_cursor*)cur );
}

static int weblog_eof( sqlite3_vtab_cursor *cur )
{
    return ((weblog_cursor*)cur)->eof;
}

static int weblog_rowid( sqlite3_vtab_cursor *cur, sqlite3_int64 *rowid )
{
    *rowid = ((weblog_cursor*)cur)->row;
    return SQLITE_OK;
}

```

The interesting function is the `xColumn()` function. If you'll recall, in addition to the line buffer, the `weblog_cursor` structure also had an array of character pointers and length values. Each of these pointers and lengths corresponds to a column value in the defined table format. Before the module can extract those values, it needs to scan the input line and mark all the columns by setting the pointer and length values.

Using a length value means the module doesn't need to insert termination characters into the original string buffer. That's good, since several of the fields overlap. Using terminating characters would require making private copies of these data fields. In the end, a length value is quite useful anyway, as most of SQLite's value-handling routines utilize length values.

The function that sets up all these pointers and length calculations is `weblog_scanline()`. We'll work our way through this section by section. At the top are, of course, the variable definitions. The `start` and `end` pointers will be used to scan the line buffer, while the `next` value keeps track of the terminating character for the current field:

```
static int weblog_scanline( weblog_cursor *c )
{
    char    *start = c->line, *end = NULL, next = ' ';
    int     i;

    /* clear pointers */
    for ( i = 0; i < TABLE_COLS; i++ ) {
        c->line_ptrs[i] = NULL;
        c->line_size[i] = -1;
    }
}
```

With the variables declared, the first order of business is to reset all of the column pointers and sizes.

Next, the scan function loops over the native data fields in the line. This scans up to nine fields from the line buffer. These fields correspond to all the primary fields in a *combine* format logfile. If the logfile is a *common* format file (with only seven fields) or if the line buffer was clipped off, fewer fields are scanned. Any fields that are not properly scanned will eventually end up returning NULL SQL values:

```
/* process actual fields */
for ( i = 0; i < TABLE_COLS_SCAN; i++ ) {
    next = ' ';
    while ( *start == ' ' ) start++; /* trim whitespace */
    if (*start == '\0') break; /* found the end */
    if (*start == '"') {
        next = '"'; /* if we started with a quote, end with one */
        start++;
    }
    else if (*start == '[') {
        next = '['; /* if we started with a bracket, end with one */
        start++;
    }
    end = strchr( start, next ); /* find end of this field */
    if ( end == NULL ) { /* found the end of the line */
        int len = strlen ( start );
        end = start + len; /* end now points to '\0' */
    }
    c->line_ptrs[i] = start; /* record start */
    c->line_size[i] = end - start; /* record length */
    while ( ( *end != ' ' ) &&( *end != '\0' ) ) end++; /* find end */
    start = end;
}
}
```

This loop attempts to scan one field at a time. The first half of the loop figures out the ending character of the field. In most cases it is a space, but it can also be a double-quote or square bracket. Once it knows what it's looking for, the string is scanned for the next end marker. If the marker isn't found, the rest of the string is used.

When this loop exits, the code has attempted to set up the first nine column pointers. These make up the native fields of the logfile. The next step is to set up pointers and lengths for the additional 11 columns that represent subfields and alternate representations. The first additional value is the IP address, returned as an integer. This function doesn't do data conversions, so a direct copy of pointer and length from the first column can be made:

```
/* process special fields */
/* ip_int - just copy */
c->line_ptrs[9] = c->line_ptrs[0];
c->line_size[9] = c->line_size[0];
```

Next, all of the date field pointers and lengths are set up. This section of code makes some blatant assumptions about the format of the timestamp, but there isn't much choice. The code could scan the individual fields, but it would still be forced to make assumptions about the ordering of the fields. In the end, it is easiest to just assume the format is consistent and hardcode the field lengths. This example ignores the time zone information:

```
/* assumes: "DD/MMM/YYYY:HH:MM:SS zone" */
/* idx: 012345678901234567890... */
if ( ( c->line_ptrs[3] != NULL ) && ( c->line_size[3] >= 20 ) ) {
    start = c->line_ptrs[3];
    c->line_ptrs[10] = &start[0];    c->line_size[10] = 2;
    c->line_ptrs[11] = &start[3];    c->line_size[11] = 3;
    c->line_ptrs[12] = &start[3];    c->line_size[12] = 3;
    c->line_ptrs[13] = &start[7];    c->line_size[13] = 4;
    c->line_ptrs[14] = &start[12];   c->line_size[14] = 2;
    c->line_ptrs[15] = &start[15];   c->line_size[15] = 2;
    c->line_ptrs[16] = &start[18];   c->line_size[16] = 2;
}
}
```

After the date fields, the next step is to extract the HTTP operation and URL. These are extracted as the first two subfields of the HTTP Request log field. The code plays some games to be sure it doesn't accidentally pass a NULL pointer into `strchr()`, but otherwise it just finds the first two spaces and considers those to be the ending of the two fields it is trying to extract:

```
/* req_op, req_url */
start = c->line_ptrs[4];
end = ( start == NULL ? NULL : strchr( start, ' ' ) );
if ( end != NULL ) {
    c->line_ptrs[17] = start;
    c->line_size[17] = end - start;
    start = end + 1;
}
end = ( start == NULL ? NULL : strchr( start, ' ' ) );
if ( end != NULL ) {
    c->line_ptrs[18] = start;
    c->line_size[18] = end - start;
}
}
```

The final column represents the full contents of the line buffer. We also need to set the valid flag to indicate the field pointers are valid and ready for use:

```
/* line */
c->line_ptrs[19] = c->line;
c->line_size[19] = c->line_len;

c->line_ptrs_valid = 1;
return SQLITE_OK;
}
```

Once this function has been called, all the fields that could be scanned will have a valid pointer and length value. With the data scanned, this and subsequent calls to `xColumn()` can use the relevant values to pass back their database values. Let's return to looking at `xColumn()`.

The first thing the `xColumn()` code does is making sure the line has already been scanned. If not, the code calls `weblog_scanline()` to set up all the field pointers:

```
static int weblog_column( sqlite3_vtab_cursor *cur, sqlite3_context *ctx, int cidx )
{
    weblog_cursor *c = (weblog_cursor*)cur;

    if ( c->line_ptrs_valid == 0 ) {
        weblog_scanline( c );          /* scan line, if required */
    }
    if ( c->line_size[cidx] < 0 ) { /* field not scanned and set */
        sqlite3_result_null( ctx );
        return SQLITE_OK;
    }
}
```

Next, if the requested column doesn't have a valid set of values, the module passes back an SQL NULL for the column.

The code then processes columns with specific conversion needs. Any column that needs special processing or conversion will be caught by this switch statement. The first specialized column is the integer version of the IP address. This block of code converts each octet of the IP address into an integer value. The only issue is that all integer values within SQLite are signed, so the code needs to be careful about constructing the value into a 64-bit integer. For maximum compatibility, it avoids using shift operations:

```
switch( cidx ) {
case 9: { /* convert IP address string to signed 64 bit integer */
    int i;
    sqlite_int64 v = 0;
    char *start = c->line_ptrs[cidx], *end, *oct[4];

    for ( i = 0; i < 4; i++ ) {
        oct[i] = start;
        end = ( start == NULL ? NULL : strchr( start, '.' ) );
        if ( end != NULL ) {
            start = end + 1;
        }
    }
}
```

```

    }
    v += ( oct[3] == NULL ? 0 : atoi( oct[3] ) ); v *= 256;
    v += ( oct[2] == NULL ? 0 : atoi( oct[2] ) ); v *= 256;
    v += ( oct[1] == NULL ? 0 : atoi( oct[1] ) ); v *= 256;
    v += ( oct[0] == NULL ? 0 : atoi( oct[0] ) );
    sqlite3_result_int64( ctx, v );
    return SQLITE_OK;
}

```

The next specialized column is one of the two month fields. In the logfile, the month value is given as a three-character abbreviation. One column returns this original text value, while another returns a numeric value. To convert from the abbreviation to the numeric value, the code simply looks for constants in the month string. If it can't find a match, the code breaks out. As we'll see, if the code breaks out it will eventually end up returning the text value:

```

case 12: {
    int m = 0;
        if ( strcmp( c->line_ptrs[ciidx], "Jan", 3 ) == 0 ) m = 1;
    else if ( strcmp( c->line_ptrs[ciidx], "Feb", 3 ) == 0 ) m = 2;
    else if ( strcmp( c->line_ptrs[ciidx], "Mar", 3 ) == 0 ) m = 3;
    else if ( strcmp( c->line_ptrs[ciidx], "Apr", 3 ) == 0 ) m = 4;
    else if ( strcmp( c->line_ptrs[ciidx], "May", 3 ) == 0 ) m = 5;
    else if ( strcmp( c->line_ptrs[ciidx], "Jun", 3 ) == 0 ) m = 6;
    else if ( strcmp( c->line_ptrs[ciidx], "Jul", 3 ) == 0 ) m = 7;
    else if ( strcmp( c->line_ptrs[ciidx], "Aug", 3 ) == 0 ) m = 8;
    else if ( strcmp( c->line_ptrs[ciidx], "Sep", 3 ) == 0 ) m = 9;
    else if ( strcmp( c->line_ptrs[ciidx], "Oct", 3 ) == 0 ) m = 10;
    else if ( strcmp( c->line_ptrs[ciidx], "Nov", 3 ) == 0 ) m = 11;
    else if ( strcmp( c->line_ptrs[ciidx], "Dec", 3 ) == 0 ) m = 12;
    else break; /* give up, return text */
    sqlite3_result_int( ctx, m );
    return SQLITE_OK;
}

```

There are a number of additional columns (including some of the “native” ones) that are returned as integers. None of these columns require special processing, other than the string-to-integer conversion. The standard `atoi()` function is used for this conversion. Although the string pointers are not null-terminated, the `atoi()` function will automatically return once it encounters a non-numeric character. Since all of these fields are bound by spaces or other characters, this works out exactly the way we want:

```

case 5: /* result code */
case 6: /* bytes transfered */
case 10: /* day-of-month */
case 13: /* year */
case 14: /* hour */
case 15: /* minute */
case 16: /* second */
    sqlite3_result_int( ctx, atoi( c->line_ptrs[ciidx] ) );
    return SQLITE_OK;
default:
    break;
}

```



```

sqlite3_result_text( ctx, c->line_ptrs[cidx],
                    c->line_size[cidx], SQLITE_STATIC );
return SQLITE_OK;
}

```

Finally, any field that did not require special processing is returned as a text value. Although the line buffer will be overwritten when the next line is read, the data pointer passed into `sqlite3_result_text()` only needs to stay valid until the next call to `xNext()`. This allows the module to use the `SQLITE_STATIC` flag.

With that, we've defined all the required functions for our weblog module.

## Register the Module

Now that we've seen how all the module functions are implemented, the last thing to do is register the weblog module as part of the extension initialization function:

```

static sqlite3_module weblog_mod = {
    1,                /* iVersion      */
    weblog_connect,   /* xCreate()     */
    weblog_connect,   /* xConnect()    */
    weblog_bestindex, /* xBestIndex()  */
    weblog_disconnect, /* xDisconnect() */
    weblog_disconnect, /* xDestroy()    */
    weblog_open,      /* xOpen()       */
    weblog_close,     /* xClose()      */
    weblog_filter,    /* xFilter()     */
    weblog_next,      /* xNext()       */
    weblog_eof,       /* xEOF()        */
    weblog_column,    /* xColumn()     */
    weblog_rowid,     /* xRowid()      */
    NULL,             /* xUpdate()     */
    NULL,             /* xBegin()      */
    NULL,             /* xSync()       */
    NULL,             /* xCommit()     */
    NULL,             /* xRollback()   */
    NULL,             /* xFindFunction() */
    weblog_rename     /* xRename()     */
};

int weblog_init( sqlite3 *db, char **error, const sqlite3_api_routines *api )
{
    SQLITE_EXTENSION_INIT2(api);
    return sqlite3_create_module( db, "weblog", &weblog_mod, NULL );
}

```

Since there is no attempt to create an instance of a weblog table, this initialization function is a bit simpler than the previous `dblist` example.

## Example Usage

Now that we've worked through the whole example, let's see what the code can do. Here are a few different examples that show off the power of the weblog module.

While doing these types of queries is not a big deal for people that are comfortable with SQL, realize that we can run all of these queries without having to first import the logfile data. Not only does that make the whole end-to-end process much faster, it means we can run these types of queries against active, “up to the second” logfiles.

To show off how this module works, the server administrators of <http://oreilly.com/> were nice enough to provide me with some of their logfiles. The file referred to as *oreilly.com\_access.log* is an Apache *combine* logfile with 100,000 lines of data. Once compiled and built into a loadable module, we can import the weblog module and create a virtual table that is bound to this file using these commands:

```
sqlite> .load weblog.sqlite3ext weblog_init
sqlite> CREATE VIRTUAL TABLE log USING weblog( oreilly.com_access.log );
```

We then issue queries to look at different aspects of the file. For example, if we want to know what the most common URL is, we run a query like this:

```
sqlite> SELECT count(*) AS Count, req_url AS URL FROM log
...> GROUP BY 2 ORDER BY 1 DESC LIMIT 8;
```

Count	URL
2490	/images/oreilly/button_cart.gif
2480	/images/oreilly/button_acct.gif
2442	/styles/all.css
2348	/images/oreilly/888-line.gif
2233	/styles/chrome.css
2206	/favicon.ico
1975	/styles/home2.css
1941	/images/oreilly/satisfaction-icons.gif

It is fairly common to see *favicon.ico* very near the top, along with any site-wide CSS and image files. In the case of smaller sites that have a lot less traffic, it isn’t uncommon for the most requested URL to be */robots.txt*, which is used by search engines.

We can also see what the most expensive items on the website are, in terms of bytes moved:

```
sqlite> SELECT sum(bytes) AS Bytes, count(*) AS Count, req_url AS URL
...> FROM log WHERE result = 200 GROUP BY 3 ORDER BY 1 DESC LIMIT 8;
```

Bytes	Count	URL
46502163	1137	/images/oreilly/mac_os_x_snow_leopard-148.jpg
40780252	695	/
37171328	2384	/styles/all.css
35403200	2180	/styles/chrome.css
31728906	781	/catalog/assets/pwr/engine/js/full.js
31180460	494	/catalog/9780596510046/index.html
21573756	88	/windows/archive/PearPC.html
21560154	3	/catalog/dphotohdbk/chapter/ch03.pdf

We see that some of these items are not that large, but are requested frequently. Other items have only a small number of requests, but are big enough to make a noticeable contribution to the total number of served bytes.

Here is one final example. This shows what IP addresses are downloading the most number of unique items. Since this is from live data, I've altered the IP addresses:

```
sqlite> SELECT count(*) AS Uniq, sum(sub_count) AS Ttl,
...>      sum(sub_bytes) AS TtlBytes, sub_ip AS IP
...> FROM (SELECT count(*) AS sub_count, sum(bytes) AS sub_bytes,
...>        ip_str AS sub_ip FROM log GROUP BY 3, req_url)
...> GROUP BY 4 ORDER BY 1 DESC LIMIT 8;
```

Uniq	Ttl	TtlBytes	IP
1295	1295	31790418	10.5.69.83
282	334	13571771	10.170.13.97
234	302	4234382	10.155.7.28
213	215	3089112	10.155.7.77
163	176	2550477	10.155.7.29
159	161	4279779	10.195.137.175
153	154	2292407	10.23.146.198
135	171	2272949	10.155.7.71

For each IP address, the first column is the number of unique URLs requested, while the second column is the total number of requests. The second column should always be greater than or equal to the first column. The third column is the total number of bytes, followed by the (altered) IP address in question. Exactly how this query works is left as an exercise for the reader.

There are countless other queries we could run. For anyone that has ever imported log data into an SQL database and played around with it, none of this is particularly inspiring. But consider this for a moment: the query time for the first two of these examples is a bit less than five seconds on an economy desktop system that is several years old. The third query was a bit closer to eight seconds.

Five seconds to scan a 100,000-row table might not be blazingly fast, but remember that those five seconds are the grand total for everything, including data “import.” Using the virtual table module allows us to go from a raw logfile with 100,000 lines to a query answer in just that amount of time—no data staging, no format conversions, no data imports. That’s important, since importing involves a lot of I/O and can be a slow process. For example, importing the same file into a standard SQLite table by more traditional means takes nearly a minute and that doesn’t even include any queries!

Now consider that we enable all this functionality with less than 400 lines of C code. Accessing the original data, rather than importing it into standard tables, allows the end-to-end data analysis process to be much faster, and allows you to query the data, as it is recorded by the web server, in real time. As an added bonus, the virtual table can also be used as an importer, by using the CREATE TABLE... AS or INSERT... SELECT SQL commands.

If you find yourself faced with the task of writing a script to analyze, search, or summarize some structured source of data, you might consider writing an SQLite module instead. A basic, read-only module is a fairly minor project, and once you've got that in place you have the complete power of the SQLite database engine at your disposal (plus an added data importer!). That makes it easy to write, test, and tune whatever queries you need in just a few lines of SQL.

## Best Index and Filter

Let's take a closer look at the `xBestIndex()` and `xFilter()` functions. Both of our example modules were fairly simple and didn't use them, but proper use of these functions is critical for internal modules that implement some types of high-performance indexing system.

### Purpose and Need

By default, the only way to get data out of a table—virtual or otherwise—is to do a full table scan. This can be quite expensive, especially if the table is large and the query is trying to extract a small number of rows.

Standard tables have ways of boosting retrieval speeds, such as using indexes. The query optimizer can use other hints found in a standard table definition, such as knowing which columns are unique or have other constraints on them.

Virtual tables lack these features. You cannot create an index on a virtual table, and the query optimizer has no knowledge of the structure or format of a virtual table, other than the column names. The only known constraint on a virtual table is that each virtual row must have a unique, integer `ROWID`.

Without any additional information, it is very difficult to optimize a query that involves a virtual table. This is true for both the query planner and the virtual table itself. For the best performance, the query optimizer needs to understand what types of lookups the virtual table is best suited to doing. Conversely, the virtual table module needs to understand the nature of the user query, including any constraints, so that it can use any internal indexes or lookup optimizations to the best of its ability.

The purpose of the `xBestIndex()` and `xFilter()` functions is to bridge this gap. When an SQL statement is prepared, the query optimizer may call `xBestIndex()` several times, presenting several different query possibilities. This allows the module to formulate its own query plan and pass back an approximate cost metric to the query optimizer. The query optimizer will use this information to pick a specific query plan.

When the query statement is executed, the SQLite library uses `xFilter()` to communicate back to the module which query plan was actually chosen. The module can use this information to optimize its internal data lookups, as well as skip over any rows

that are not relevant to the query at hand. This allows a virtual table to implement more targeted data lookups and retrievals, not unlike an index on a traditional table.

## xBestIndex()

If you'll recall, the `xBestIndex()` function is a table-level function that looks like this:

```
int xBestIndex( sqlite3_vtab *vtab, sqlite3_index_info *idxinfo );
```

The whole key to this function is the `sqlite3_index_info` structure. This structure is divided into two sections. The first section provides a series of inputs to your function, allowing SQLite to propose a query plan to the module. The input section should be treated as read-only.

The second section is the output section. A module uses this second section to communicate back to the query optimizer information about which constraints the virtual table is prepared to enforce, and how expensive the proposed query might be. The module is also given a chance to associate an internal query plan or other data to this particular proposal. The query optimizer will then use this data to select a specific query plan.

The input section consists of two size values and two arrays. The `nConstraint` integer indicates how many elements are in the `aConstraint[]` array. Similarly, the `nOrderBy[]` integer indicates how many elements are in the `aOrderBy[]` array:

```
struct sqlite3_index_info {
    /*** Inputs ***/
    int      nConstraint;           /* Number of entries in aConstraint */
    struct sqlite3_index_constraint {
        int      iColumn;          /* Column on lefthand side of constraint */
        unsigned char op;          /* Constraint operator */
        unsigned char usable;      /* True if this constraint is usable */
        int      iTermOffset;      /* Used internal - xBestIndex should ignore */
    } *aConstraint;                /* Table of WHERE clause constraints */

    int      nOrderBy;            /* Number of terms in the ORDER BY clause */
    struct sqlite3_index_orderby {
        int      iColumn;          /* Column number */
        unsigned char desc;        /* True for DESC. False for ASC. */
    } *aOrderBy;                  /* The ORDER BY clause */
};
```

The `aConstraint[]` array communicates a series of simple constraints that a query may put on the virtual table. Each array element defines one query constraint by passing values for a column index (`aConstraint[i].iColumn`) and a constraint operator (`aConstraint[i].op`). The column index refers to the columns of the virtual table, with a zero signifying the first column. An index of -1 indicates the constraint is being applied to the virtual `ROWID` column.

The specific constraint operator is indicated with one of these constants. The referenced column (the column index) is always assumed to be on the lefthand side. These are the only operators that can be optimized by a virtual table:

```

SQLITE_INDEX_CONSTRAINT_EQ      /* COL = Expression */
SQLITE_INDEX_CONSTRAINT_GT      /* COL > Expression */
SQLITE_INDEX_CONSTRAINT_LE      /* COL <= Expression */
SQLITE_INDEX_CONSTRAINT_LT      /* COL < Expression */
SQLITE_INDEX_CONSTRAINT_GE      /* COL >= Expression */
SQLITE_INDEX_CONSTRAINT_MATCH   /* COL MATCH Expression */

```

For example, if one of the `aConstraint` elements had the values:

```

aConstraint[i].iColumn = -1;
aConstraint[i].op      = SQLITE_INDEX_CONSTRAINT_LE;

```

That would roughly translate to a `WHERE` clause of:

```

...WHERE ROWID <= ?

```

The parameter on the right side of the expression may change from query to query, but will remain constant for the any given table scan, just as if it were a statement parameter with a bound value.

Each `aConstraint[]` element also contains a `usable` element. Some constraints may not be usable by the optimizer due to joins or other external conditions put on the query. Your code should only pay attention to those constraints where the usable field is nonzero.

The second array of the input section, `aOrderBy[]`, communicates a set of requested `ORDER BY` sortings (it may also be generated by columns in a `GROUP BY` clause). Each ordering element is defined by a column index and a direction (ascending or descending). The column indexes work the same way, with defined columns starting at 0 and -1 referring to the `ROWID`. The ordering elements should be treated as a series of `ORDER BY` arguments, with the whole data set being sorted by the first ordering, then subsets of equal values being sorted by the second ordering, and so on.

The output section contains the data that is passed back to the SQLite optimizer. It consists of a constraint array and a set of values. The `aConstraintUsage[]` array will always be the same size as the `aConstraint[]` array (that is, will always have `nConstraint` elements). SQLite will always zero out the memory used by the output section. This is why it is safe to ignore the structure in simplified implementations of `xBestIndex()`—the structure is basically preset to an answer of, “this module cannot optimize anything.” In that case, every virtual table query will require a full table scan:

```

/**** Outputs ****/
struct sqlite3_index_constraint_usage {
    int          argvIndex; /* If >0, constraint is part of argv to xFilter */
    unsigned char omit;     /* Do not code a test for this constraint */
} *aConstraintUsage;

int    idxNum;          /* Number used to identify the index */
char  *idxStr;         /* Application-defined string */
int    needToFreeIdxStr; /* Free idxStr using sqlite3_free() if true */
int    orderByConsumed; /* True if output is already ordered */
double estimatedCost;  /* Estimated cost of using this index */
};

```

If a module is able to optimize some part of the query, this is indicated to the query optimizer by modifying the output section of the `sqlite3_index_info` structure to indicate what query optimizations the module is willing and capable of performing.

Each element of the `aConstraintUsage[]` array corresponds to the same ordered element of the `aConstraint[]` array. For each constraint described in an `aConstraint[]` element, the corresponding `aConstraintUsage[]` element is used to describe how the module wants the constraint applied.

The `argvIndex` value is used to indicate to SQLite that you want the expression value of this constraint (that is, the value on the righthand side of the constraint) to be passed to the `xFilter()` function as one of the `argv` parameters. The `argvIndex` values are used to determine the sequence of each expression value. Any `aConstraintUsage[]` element can be assigned any index value, just as long as the set of assigned index values starts with one and has no gaps. No `aConstraintUsage[]` elements should share the same nonzero `argvIndex` value. If the default `argvIndex` value of zero is returned, the expression value is not made available to the `xFilter()` function. Exactly how this is used will make more sense when we look more closely at `xFilter()`.

The `omit` field of an `aConstraintUsage[]` element is used to indicate to the SQLite library that the virtual table module will take the responsibility to enforce this constraint and that SQLite can omit the verification process for this constraint. By default, SQLite verifies the constraints of every row returned by a virtual table (e.g., every row `xNext()` stops at). Setting the `omit` field will cause SQLite to skip the verification process for this constraint.

Following the constraint array is a series of fields. The first three fields are used to communicate to the `xFilter()` function. The fields `idxNum` and `idxStr` can be used by the module however it wishes. The SQLite engine makes no use of these fields, other than to pass them back to `xFilter()`. The third field, `needToFreeIdxStr`, is a flag that indicates to the SQLite library that the memory pointed to by `idxStr` has been dynamically allocated by `sqlite3_malloc()`, and the SQLite library should free that memory with `sqlite3_free()` if the library decides it is no longer required.

This flag is needed to prevent memory leaks. Remember that `xBestIndex()` may be called several times as part of the prepare process for an SQL statement. The module will usually pass back a unique `idxStr` value for each proposed query plan. Only one of these `idxStr` values will be passed to `xFilter()`, however, and the rest must be discarded. That means that any string (or other memory block) you provide to `idxStr` needs to either be static memory, or the memory needs to be allocated with `sqlite3_malloc()` and the `needToFreeIdxStr` flag needs to be set. This allows the SQLite library to properly clean up any unused `idxStr` allocations.

The `orderByConsumed` field is used to indicate that the module is able to return the data presorted in the order defined by the `aOrderBy` array. This is an all-or-nothing flag. If three `aOrderBy` elements are given, but the module can only sort the output by the first column, it must return a false value.

Finally, the `estimatedCost` field is used to communicate a cost value back to the SQLite library. If this is an external module, this number should approximate the total number of disk accesses required to return all rows that meet the specified constraints. If this is an internal module, it can be an approximation of the number of `sqlite3_step()` and `sqlite3_column_xxx()` calls. In situations where a full table scan is required, it can estimate the number of rows in the virtual table. The exact measurement is not extremely meaningful, other than the relative values between different calls to `xBestIndex()`.

## xFilter()

The `xFilter()` function provides a way for the SQLite library to notify the module, within the context of a specific table cursor, exactly what constraints and ordering should be applied to the next table scan. Recall that the `xFilter()` prototype looks like this:

```
int xFilter( sqlite3_vtab_cursor *cursor,
            int idxNum, const char *idxStr,
            int argc, sqlite3_value **argv )
```

The first argument is the table cursor that requires these constraints. The `idxNum` and `idxStr` values are the same values that were passed back by the module in a prior call to `xBestIndex()`. These mean whatever the module wants, just as long as the code in `xBestIndex()` and `xFilter()` agrees on what they are and what the values represent.

Finally, the last two arguments are derived from the `aConstraintUsage[i].argvIndex` values passed back by the module. The `argv` parameter is an array of `sqlite3_value` structures, while the `argc` parameter indicates how many elements are in the `argv` array.

Going back to our prior example, consider an `sqlite3_index_info` structure with an `aConstraint[i]` element, where `iColumn=-1` and `op=SQLITE_INDEX_CONSTRAINT_LE` (indicating a constraint of `ROWID >= ?`). If the module's `xBestIndex()` function set `aConstraintUsage[i].argvIndex` to a value of 1, the `argv[0]` value passed into `xFilter()` will have the value found on the righthand side of the expression.

Notice that the argument indexes between `xBestIndex()` and `xFilter()` are off by one. Because `sqlite3_index_info` considers an `aConstraintUsage[i].argvIndex` value of 0 to indicate an invalid index, the `argvIndex` values start at 1. The actual `argv` indexes will all be one less, however, as they start at 0.

Using the `idxNum`, `idxStr`, and `argv` values, it is the responsibility of `xFilter()` to configure this table cursor to provide the correct constraints and ordering that were promised by the corresponding `sqlite3_index_info` block.



## Typical Usage

The design of `xBestIndex()` and `xFilter()` functions is strongly focused on optimizing internal style modules. These are modules that are going to use one or more SQL statements that operate over a set of internal tables to produce the virtual table data. This is similar to how the `dblist` module works, but normally involves more complex SQL commands.

A module is free to do whatever it wants with the `idxNum` and `idxStr` values, but most internal modules use them to pass off pre-built SQL command strings. Each time `xBestIndex()` is called, the module tries to figure out how it would service the query constraints and ordering constraints, by adding conditions, constraints, and `ORDER BY` parameters to the internal SQL statements used to generate the virtual table data. The `xBestIndex()` function marks the constraints it can use and builds the required SQL command strings, complete with statement parameters. These SQL commands are passed back with the `idxStr` value. The `idxNum` can be used to pass back a string length, or some other index value or bit flags or whatever the module wants. The `argvIndex` values of the `aConstraintUsage` elements are set to the corresponding statement parameter index values. In essence, the `xBestFilter()` function will build the SQL command strings that query the virtual table data in such a way that the required constraints and ordering are already “baked in” to the behind-the-scenes queries.

When `xFilter()` is called, the `idxStr` value will have the relevant SQL command strings for that query configuration. The SQL command strings can then be prepared, and the constraint expressions pass in via the `argv` array, and can be bound to any statement parameters. The `xFilter()` function starts to step through the prepared statements, generating the first row. Like the `dblist` internal module, subsequent calls to `xNext()` continue to step through any internal statements, returning additional rows.

As long as `xBestIndex()` can derive a reasonable set of SQL command strings that are capable of expressing the required internal query (or queries), this is all reasonably straightforward. If necessary, multiple SQL command strings can be passed into `xFilter()` by defining them one after another in a large string, and using the tail parameter of `sqlite3_prepare_xxx()` to prepare multiple statements, one after another.

Things can be difficult when dealing with external modules. Very often external modules can't define complex query conditions or sort ordering with a simple string. Although the `idxStr` pointer can be used to pass in some type of data structure, it can be difficult to encode all the constraint information. This is one of the reasons why many modules, and especially external modules, forego the use of `xBestIndex()` and `xFilter()`, and just depend on full table scans for all operations. Full table scans might be slower, but they still work.

That might sound bad, but remember that even on a standard table with a standard index, you typically don't start to see really good returns on using the index unless a constraint and appropriate index are able to eliminate 80% or better of the rows. Spending a lot of time to build a constraint handler that only filters out a small percentage of rows is normally a losing proposition. While that can be the whole point of internal modules, the primary goal of most external modules is to simply provide data connectivity. If you're working on an external module, get the basic data translation working first, and then worry about possibly implementing more efficient lookup patterns.

## Wrap-Up

If you've made it through the whole chapter, you should have a pretty good idea of what the virtual table system can do and how it works. A well-written internal module can bring a whole new feature set to the database, allowing an application to shape and manipulate data structures that SQLite might not otherwise be able to store or process in an efficient manner. External modules can provide a data conduit, providing both speed and flexibility in the use of external data sources. They can also double as powerful data importers.

That power comes at a cost, however. Without getting into filesystems and storage engines, a module is the most complex bit of extension code most people will ever write for SQLite. A good module depends on a solid design that will properly track all of the necessary states and perform all of the required functions.

To avoid frustration, it is often a good idea to start with the simple base cases and expand your code and design to cover the more complex situations.

---

# SQLite Build Options

SQLite has a fair number of compile-time options and build directives. Many of these are used to change default values, behaviors, or limits, while others are used to enable optional modules or disable existing features. One of the main reasons you may find yourself recompiling SQLite is to alter the compiler directives.

All of these directives are standard C `#define` flags. You can often define them in your IDE's build environment, as environment variables (if you're compiling from a command-line) or by passing one or more flags to your compiler.

The defaults are reasonable for most modern desktop systems. If you're developing for a mobile system, you may want to pick and choose your configuration more carefully. Some of the advanced extensions can add a considerable amount of bulk to the SQLite library, as well as demand additional resources at runtime. While these changes may not be significant to a desktop system, they may cause problems in more restricted environments.

## Shell Directives

There is only one compiler directive that is specific to the *shell.c* source file and the `sqlite3` command-line tool. This directive only needs to be defined when building the *shell.c* source. The actual SQLite core does not recognize this directive.

See also [SQLITE\\_ENABLE\\_IOTRACE](#) later in this appendix, which enables the `.iotrace` command in `sqlite3`, but must be defined when compiling both *shell.c* and *sqlite3.c*.

---

### ENABLE\_READLINE

Enable the GNU Readline library

#### Common Usage

```
ENABLE_READLINE=1
```

#### Default

undefined (unused)

## Description

A value of 1 enables use of the GNU Readline library. When this is enabled, the Readline library must be linked in as part of the build process.

## Default Values

The following compiler directives are used to alter the default value for different database parameters. These directives alter the default startup values. Most of these parameters can be changed at runtime.

In general, if you alter a default value for your application, it is also a good idea to alter the default values for any tools you might use (e.g., the `sqlite3` command-line tool). Having everything using the same set of defaults reduces the chance that the configuration values inherited by a new database will be out of sync with the rest of the system.

Conversely, if your application has critical dependencies on specific settings, it would be best to explicitly set those values at runtime through an appropriate SQL command or API call, even if you also configure the appropriate defaults when building the library. This guarantees that the values will remain correct, regardless of the SQLite library configuration.

---

## SQLITE\_DEFAULT\_AUTOVACUUM

Default auto-vacuum mode

### Common Usage

```
SQLITE_DEFAULT_AUTOVACUUM=<0|1|2>
```

### Default

0 (auto-vacuum disabled)

### Description

Sets the default auto-vacuum mode for new databases. The default value of 0 completely disables the auto-vacuum functionality.

Value	Mode	Meaning
0	None	Auto-vacuum disabled
1	Full	Auto-vacuum enabled, running
2	Incremental	Auto-vacuum enabled, deferred

### See Also

[auto\\_vacuum](#) [PRAGMA, Ap F]

---

## SQLITE\_DEFAULT\_CACHE\_SIZE

Default maximum cache size

### Common Usage

`SQLITE_DEFAULT_CACHE_SIZE=number-of-pages`

### Default

2000 pages

### Description

Sets the default maximum cache size, in pages, of a new database.

### See Also

[default\\_cache\\_size](#) [PRAGMA, Ap F], [cache\\_size](#) [PRAGMA, Ap F]

---

## SQLITE\_DEFAULT\_FILE\_FORMAT

Default file format

### Common Usage

`SQLITE_DEFAULT_FILE_FORMAT=<1|4>`

### Default

1 (original/legacy format)

### Description

Sets the default file format. SQLite 3.3.0 introduced a new file format (4) that understands descending indexes and uses a more efficient encoding for Boolean values (integer values 0 and 1). All versions of SQLite after 3.3.0 can read and write both file formats. SQLite versions before 3.3.0 can only understand the original (1) format.

As the number of pre-3.3.0 users declines, it is expected that the default version will be changed to the newer file format.

### See Also

[legacy\\_file\\_format](#) [PRAGMA, Ap F]

---

## SQLITE\_DEFAULT\_JOURNAL\_SIZE\_LIMIT

Default size limit for persistent journals

### Common Usage

`SQLITE_DEFAULT_JOURNAL_SIZE_LIMIT=bytes`

### Default

Undefined (unlimited)

### Description

Sets the default size limit for persistent journal files. When this directive is undefined, there is no limit. This limit may be set at runtime.

SQLITE\_DEFAULT\_MEMSTATUS

## See Also

[journal\\_size\\_limit](#) [PRAGMA, Ap F]

---

## SQLITE\_DEFAULT\_MEMSTATUS

Memory status configuration

### Common Usage

```
SQLITE_DEFAULT_MEMSTATUS=<0|1>
```

### Default

1 (enabled and available)

### Description

Sets the default configuration (enabled or disabled) of the memory status system. Memory status must be available for the `sqlite3_memory_used()`, `sqlite3_memory_highwater()`, `sqlite3_soft_heap_limit()`, or `sqlite3_status()` API functions to provide valid data. The memory status system can be enabled or disabled at runtime using `sqlite3_config()`.

## See Also

[sqlite3\\_config\(\)](#) [C API, Ap G]

---

## SQLITE\_DEFAULT\_PAGE\_SIZE

Default database page size

### Common Usage

```
SQLITE_DEFAULT_PAGE_SIZE=bytes
```

### Default

1024 bytes

### Description

Sets the default page size of a database in bytes. Values must be a power-of-two value between 512 and `SQLITE_MAX_PAGE_SIZE`, which defaults to 32 KB (and is the maximum value supported). Possible values include: 512, 1024, 2048, 4096, 8192, 16384, or 32768.

## See Also

[SQLITE\\_MAX\\_PAGE\\_SIZE](#), [page\\_size](#) [PRAGMA, Ap F]

---

## SQLITE\_DEFAULT\_TEMP\_CACHE\_SIZE

Temporary cache size

### Common Usage

```
SQLITE_DEFAULT_TEMP_CACHE_SIZE=number-of-pages
```

### Default

500 pages

**Description**

Sets the default maximum size of any temporary page cache. Temporary page caches are used to store intermediate results and other transitory data. Temporary databases use a standard page cache and do not use this value. There is no way to modify this value at runtime.

**YYSTACKDEPTH**

Maximum parser stack depth

**Common Usage**

`YYSTACKDEPTH=max-depth`

**Default**

100

**Description**

Sets the maximum stack-depth of the parser used to process SQL statements. It is very unusual for applications to require a value greater than 25. If you find yourself adjusting this value upwards, you most likely need to reconsider your SQL style.

**Sizes and Limits**

In moving from SQLite 2 to SQLite 3, one of the major design goals was to eliminate as many limitations as possible. Algorithms and data structures were designed to scale to extreme values. Unfortunately, this “knows no bounds” approach was in conflict with the desire to have comprehensive testing. In many cases it was difficult, if not impossible, to test the extreme limits. This led to the uncomfortable situation where SQLite was “known” to be reliable, as long as your usage patterns didn’t push too far beyond the tested limits. If you ventured too far out into uncharted territory, the stability and reliability was less known and less understood, and over time a number of bugs were found when things were pushed beyond sane values.

As a result, many of the default maximum values have been reined in from the absurd to the extremely unlikely. You’ll notice that most of these values are fairly large and should not present a practical limit for nearly any properly formed database. In fact, if you find yourself making these values larger, you should likely take a moment to consider what design decisions lead to the need for adjustment. In many cases, a better solution will be found in adjusting the design of the database, rather than adjusting the limits. If you adjust these limits at all, it might be best to make them smaller. This will help catch overflow and runaway systems.

Despite their comfortable size, these limits are small enough to allow testing up to and including the maximum values. This allows SQLite to provide the same level of confidence and stability across the entire operational domain.

SQLITE\_MAX\_ATTACHED

Although these compile-time directives are used to define absolute maximums, all of these limits can be lowered at runtime with the `sqlite3_limit()` API call. See the entry [sqlite3\\_limit\(\)](#) in [Appendix G](#) for more information.

---

## SQLITE\_MAX\_ATTACHED

Max number of attached databases

### Common Usage

`SQLITE_MAX_ATTACHED=number-of-databases`

### Default

10 databases

### Description

The maximum number of databases that can be attached to a single session. There is a hard limit of 30.

---

## SQLITE\_MAX\_COLUMN

Max number of columns in any structure

### Common Usage

`SQLITE_MAX_COLUMN=number-of-columns`

### Default

2000 columns

### Description

The maximum number of columns on any database table, index, or view, as well as any transient tables found in a `SELECT`. There is a hard limit of 32,767.

---

## SQLITE\_MAX\_COMPOUND\_SELECT

Max terms in compound statement

### Common Usage

`SQLITE_MAX_COMPOUND_SELECT=number-of-select-terms`

### Default

500 terms

### Description

The maximum number of `SELECT` terms in a compound `SELECT` statement (a statement that uses `UNION`, `UNION ALL`, `INTERSECT`, or `EXCEPT`).



---

**SQLITE\_MAX\_DEFAULT\_PAGE\_SIZE**

Upper bound on automatic page size

**Common Usage**`SQLITE_MAX_DEFAULT_PAGE_SIZE=bytes`**Default**

8192 bytes

**Description**

Normally, SQLite creates a database with pages that are `SQLITE_DEFAULT_PAGE_SIZE` in size. However, if the filesystem driver indicates a larger size may offer better performance, SQLite may choose a different default page size. In those situations where SQLite chooses a nondefault value, the actual page size will be limited to this size or smaller.

**See Also**[SQLITE\\_DEFAULT\\_PAGE\\_SIZE](#)

---

**SQLITE\_MAX\_EXPR\_DEPTH**

Max SQL expression tree depth

**Common Usage**`SQLITE_MAX_EXPR_DEPTH=stack-depth`**Default**

1000 levels

**Description**

Maximum depth of an SQL expression tree. This is used to limit the stack-space used when parsing a large SQL expression. A value of 0 represents no limit.

---

**SQLITE\_MAX\_FUNCTION\_ARG**

Max number of function arguments

**Common Usage**`SQLITE_MAX_FUNCTION_ARG=number-of-arguments`**Default**

127 arguments

**Description**

The maximum number of arguments in an SQL function. There is a hard upper limit of 1,000.

---

## SQLITE\_MAX\_LENGTH

Max row size

### Common Usage

`SQLITE_MAX_LENGTH=bytes`

### Default

1000000000 (1,000,000,000) bytes

### Description

The maximum length of a row, including any BLOB values. The maximum supported value is 2,147,483,647 bytes (2 GB).

---

## SQLITE\_MAX\_LIKE\_PATTERN\_LENGTH

Max search pattern length

### Common Usage

`SQLITE_MAX_LIKE_PATTERN_LENGTH=bytes`

### Default

50000 bytes

### Description

The maximum length of a LIKE or GLOB search pattern. A maliciously crafted search pattern can consume a large number of resources, so if you allow arbitrary user search patterns, you might consider significantly lowering this value.

---

## SQLITE\_MAX\_PAGE\_COUNT

Max number of pages in a database

### Common Usage

`SQLITE_MAX_PAGE_COUNT=number-of-pages`

### Default

1073741823 (1,073,741,823) pages, or one giga-page

### Description

The maximum number of pages in a single database. This, along with the current page size, defines the maximum size for a database file. With the default page size of 1024 bytes, this limits database files to one terabyte. With the maximum page size of 32 KB, this limits database files to 32 terabytes.

In theory, this number can be raised as high as 4,294,967,296 (largest 32-bit unsigned integer), but there should be little need to increase this value.

### See Also

[SQLITE\\_DEFAULT\\_PAGE\\_SIZE](#), [max\\_page\\_count](#) [PRAGMA, Ap F], [page\\_size](#) [PRAGMA, Ap F]

---

**SQLITE\_MAX\_PAGE\_SIZE**

Max database page size

**Common Usage**SQLITE\_MAX\_PAGE\_SIZE=*bytes***Default**

32768 bytes

**Description**

The maximum size of a database page. The default 32K value is the maximum allowed by the internal architecture of SQLite. This value can only be lowered.

**See Also**[SQLITE\\_DEFAULT\\_PAGE\\_SIZE](#)

---

**SQLITE\_MAX\_SQL\_LENGTH**

Max SQL statement length

**Common Usage**SQLITE\_MAX\_SQL\_LENGTH=*bytes***Default**

1000000 (1,000,000) bytes

**Description**

The maximum length of an SQL statement.

---

**SQLITE\_MAX\_TRIGGER\_DEPTH**

Max trigger recursion depth

**Common Usage**SQLITE\_MAX\_TRIGGER\_DEPTH=*depth***Default**

1000

**Description**

The maximum recursion level for triggers. This value is only meaningful when recursive triggers are enabled.

---

**SQLITE\_MAX\_VARIABLE\_NUMBER**

Max bind variables in SQL statement

**Common Usage**SQLITE\_MAX\_VARIABLE\_NUMBER=*number-of-variables***Default**

999 variables

SQLITE\_CASE\_SENSITIVE\_LIKE

### Description

The maximum number of bind variables in a prepared SQL statement.

## Operation and Behavior

These directives alter some of the fundamental behaviors of SQLite. Most of these are related to getting SQLite working on platforms with limited support.

---

### SQLITE\_CASE\_SENSITIVE\_LIKE

Define LIKE case sensitivity

#### Common Usage

```
SQLITE_CASE_SENSITIVE_LIKE
```

#### Default

Undefined (not case-sensitive)

#### Description

If defined, the LIKE operator will be case-sensitive by default.

#### See Also

[LIKE](#) [SQL Expr, Ap D], [case\\_sensitive\\_like](#) [PRAGMA, Ap F]

---

### SQLITE\_HAVE\_ISNAN

Use system isnan() function

#### Common Usage

```
SQLITE_HAVE_ISNAN
```

#### Default

Undefined (use internal function)

#### Description

If defined, SQLite will use the system `isnan()` function to determine if a floating-point value is a valid or not. Normally, SQLite uses an internal version of this function.

---

### SQLITE\_OS\_OTHER

Override default OS detection

#### Common Usage

```
SQLITE_OS_OTHER=<0|1>
```

#### Default

0

## Description

SQLite has an `SQLITE_OS_*` directive for each operating system it natively supports. Normally, SQLite will try to determine what operating system it is running on by examining various automatic compiler directives. If you're cross-compiling, you can manually set `SQLITE_OS_OTHER` to `1`. This will override all other `SQLITE_OS_*` flags and disable the default operating system interfaces. This directive is mainly of interest to people working on embedded systems.

---

## SQLITE\_SECURE\_DELETE

Enable secure delete

### Common Usage

```
SQLITE_SECURE_DELETE
```

### Default

Undefined (no overwrites)

### Description

If defined, this directive sets the default secure delete option to on. SQLite will zero out deleted rows, as well as zero out and write back any recovered database pages before adding them to the free list. This prevents someone from recovering deleted data by examining the database file.

Be aware that SQLite cannot securely delete information from the underlying storage device. If the write operation causes the filesystem to allocate a new device-level block, the old data may still exist on the raw device. There is also a slight performance penalty associated with this directive.

### See Also

[secure\\_delete](#) [PRAGMA, Ap F]

---

## SQLITE\_THREADSafe

Specify thread mode

### Common Usage

```
SQLITE_THREADSafe=<0|1|2>
```

### Default

1 (serialized mode)

### Description

Sets the default thread mode. SQLite supports three thread modes.

Value	Mode	Meaning
0	Single thread	Disables thread support
1	Fully serialized	Full thread support
2	Multithread	Basic thread support

## SQLITE\_TEMP\_STORE

Single thread mode disables all mutexes and thread support. In this mode, the locking code is completely removed from the build and the mode cannot be changed. All interaction with the SQLite library must be done from a single thread.

Serialized allows a database connection to be used across multiple threads. Multithread allows the SQLite library to be used by multiple threads, but a database connection can only be used by one thread at a time.

If an application is built with thread support, it can switch between thread-safe modes (1 or 2) at application startup.

### See Also

[sqlite3\\_threadsafe\(\)](#) [C API, Ap G]

---

## SQLITE\_TEMP\_STORE

Specify temporary storage location

### Common Usage

```
SQLITE_TEMP_STORE=<0|1|2|3>
```

### Default

1 (use files, allow override)

### Description

This directive controls how temporary files are stored. Temporary files may either be stored on disk or in memory. Rollback journals and master journals are always stored on disk. This parameter applies to temporary databases (used to store temporary tables), materialized views and subqueries, transient indexes, and transient databases used by `VACUUM`. It is perfectly safe to use memory based temporary storage.

Value	Temp. storage location
0	Always on disk
1	Defaults to on disk, allows override
2	Defaults to in memory, allows override
3	Always in memory

### See Also

[temp\\_store](#) [PRAGMA, Ap F], [sqlite3\\_config\(\)](#) [C API, Ap G]

## Debug Settings

SQLite includes a small number of directives used for enabling various debugging facilities. They can be activated by simply defining the directive. No specific value is required. Normally, these debug directives are only used for testing and development purposes, as they add significant overhead and make everything run noticeably slower.

All of these directives are undefined by default. Simply defining the directive will enable the feature.

---

## SQLITE\_DEBUG

General debugging and sanity checking

### Description

This directive is used for debugging SQLite. Defining this directive turns on a great number of assert tests, as well as some other debugging facilities.

---

## SQLITE\_MEMDEBUG

Debug the memory allocator

### Description

This directive is used to debug the memory allocator. If defined, an instrumented memory allocator is in place of the normal dynamic memory system.

## Enable Extensions

This section includes compiler directives that can be used to turn various SQLite extensions on or off. A number of these are fairly simple changes that can be used to tailor SQLite to a specific operating environment. Others are more dramatic, and can be used to enable some major extension modules.

While there should be little risk in enabling these extensions, many of them are not as vigorously tested as the core system. You should feel free to enable what you need, but you may want to refrain from enabling an extension unless you actually need it.

All of these directives are undefined by default. Simply defining the directive will enable the feature.

---

## SQLITE\_ENABLE\_ATOMIC\_WRITE

Enable atomic write support

### Description

Enables a runtime check for filesystems that support atomic write operations. The process SQLite uses to write out changes is significantly simpler on filesystems that support atomic writes. If enabled, this parameter will cause SQLite to query the filesystem to see if it supports atomic writes and, if so, use them. This type of filesystem is still relatively rare, however, and there are costs associated with the check, so the whole thing is turned off by default.

---

**SQLITE\_ENABLE\_COLUMN\_METADATA**

Enable column metadata

**Description**

Enables the retrieval of column metadata required to support the following C API calls:

- `sqlite3_column_database_name()`
- `sqlite3_column_database_name16()`
- `sqlite3_column_table_name()`
- `sqlite3_column_table_name16()`
- `sqlite3_column_origin_name()`
- `sqlite3_column_origin_name16()`
- `sqlite3_table_column_metadata()`

---

**SQLITE\_ENABLE\_FTS3**

Enable full-text search module

**Description**

Enables full-text search module. See “[Full-Text Search Module](#)” on page 169 for more details.

---

**SQLITE\_ENABLE\_FTS3\_PARENTHESIS**

Enable FTS extended syntax

**Description**

Enables the extended FTS3 query syntax, including nested parenthetical queries and the AND and NOT keywords.

---

**SQLITE\_ENABLE\_ICU**

Enable the ICU extension

**Description**

Enables *International Components for Unicode* (<http://www.icu-project.org/>) support. This library allows SQLite to deal with non-English and non-ASCII more intelligently. Using this directive requires the ICU library to be available and linked in any build. See “[ICU Internationalization Extension](#)” on page 167 for more details.

---

**SQLITE\_ENABLE\_IOTRACE**

Enable I/O trace debugging

**Description**

Enables I/O debug output. If both the SQLite library and the `sqlite3` utility are compiled with this option, an `.iotrace` command will be included in the utility. This command will cause SQLite to log all I/O transactions to a trace file. This directive should only be used when building the `sqlite3` utility.



---

**SQLITE\_ENABLE\_LOCKING\_STYLE**

Enable extended file locking

**Description**

Enables extended locking styles. Normally, SQLite running on a Unix-like system will use POSIX `fcntl()` based locks for all files. If this parameter is defined, SQLite will change its locking style depending on the type of filesystem it is using. This flag only has significant effects under Mac OS X, where it is enabled by default. See the SQLite website for more details ([http://sqlite.org/compile.html#enable\\_locking\\_style](http://sqlite.org/compile.html#enable_locking_style)).

---

**SQLITE\_ENABLE\_MEMORY\_MANAGEMENT**

Enable extended memory management

**Description**

Enables extended memory management and tracking that allows SQLite to release unused memory upon request. This parameter is required for `sqlite3_release_memory()` and `sqlite3_soft_heap_limit()` functions to have any effect.

---

**SQLITE\_ENABLE\_MEMSYS3**

Enable alternate memory allocator

**Description**

Enables one of two alternate memory allocators. Only one can be enabled at a time. The alternate allocators are used when SQLite is in “heap” mode. This allows the application to provide a static chunk of memory that SQLite will use for all of its internal allocations. This is most commonly done with embedded systems where memory usage must be carefully controlled. `MEMSYS3` uses a hybrid allocation algorithm based off `d1malloc()`.

**See Also**[SQLITE\\_ENABLE\\_MEMSYS5](#)

---

**SQLITE\_ENABLE\_MEMSYS5**

Enable alternate memory allocator

**Description**

Enables one of two alternate memory allocators. Only one can be enabled at a time. `MEMSYS5` is essentially the same as `MEMSYS3`, only it uses a power-of-two, first-fit algorithm. `MEMSYS3` tends to be more frugal with memory, while `MEMSYS5` is better at preventing fragmentation. Determining which module is best for your specific needs is largely an issue of testing and measuring.

**See Also**[SQLITE\\_ENABLE\\_MEMSYS3](#)

---

**SQLITE\_ENABLE\_RTREE**

Enable R\*Tree spatial index

**Description**

Enables the R\*Tree extension module. R\*Trees are designed for range queries and are commonly used to store durations, coordinates, or geospatial data. See [“R\\*Trees and Spatial Indexing Module” on page 171](#) for more details.

---

**SQLITE\_ENABLE\_STAT2**

Enable extended ANALYZE statistics

**Description**

Enables the calculation of additional statistics by the ANALYZE command. If present, a 10-sample histogram will be calculated for any analyzed index. The query planner can use this data to estimate how many rows will be filtered by a range condition.

---

**SQLITE\_ENABLE\_UPDATE\_DELETE\_LIMIT**

Enable extended SQL syntax

**Description**

Enables an extended syntax for the UPDATE and DELETE commands that allows the inclusion of ORDER BY and LIMIT clauses. Because support for directives requires altering the SQL parser, this directive can only be used when building from a full development tree. It will not work if building from an amalgamation or a source distribution.

---

**SQLITE\_ENABLE\_UNLOCK\_NOTIFY**

Enable extended locking API

**Description**

Enables the `sqlite3_unlock_notify()` C API. This function allows an application to register a callback function that will be called when a shared-cache table lock is released. This build directive is only applicable to applications using the shared-cache functionality.

---

**YYTRACKMAXSTACKDEPTH**

Enable parser stack tracking

**Description**

Enables depth tracking code in the SQL parser. This can be used to determine sensible values for the YYSTACKDEPTH directive.

## Limit Features

In addition to enabling extensions that are normally disabled, there are also a small number of features that are normally enabled, but can be optionally disabled. Generally you should only need to disable these features on embedded systems that lack the required filesystem support.

All of these directives are undefined by default. Simply defining the directive will disable the feature.

---

### SQLITE\_DISABLE\_LFS

Disable large file support

#### Description

Disables large file support. If disabled, all file operations will be limited to 32-bit offsets. This limits files to two gigabytes.

---

### SQLITE\_DISABLE\_DIRSYNC

Disable directory synchronization

#### Description

Disables directory syncs. Normally, SQLite will request that the operating system synchronize the parent directory of a deleted file to ensure the directory entries are immediately updated on disk. This directive disables that synchronization.

---

### SQLITE\_ZERO\_MALLOC

Disable memory allocator

#### Description

Disables the memory allocator and replaces it with a stub allocator. This stub allocator always fails, making the SQLite library unusable. An application can provide its own memory management functions and scratch memory blocks at library startup using the `sqlite3_config()` API. This build option allows SQLite to be built on platforms that do not have native memory management routines.

## Omit Core Features

In addition to all the other build directives, SQLite has a fair number of `SQLITE_OMIT_*` compile-time directives. These are designed to remove core features from the build in an effort to make the core database library as small and compact as possible. For example, `SQLITE_OMIT_ANALYZE` eliminates all code support for the `ANALYZE` command (and subsequent query optimizations), while `SQLITE_OMIT_VIRTUALTABLE` eliminates the entire virtual table facility.

In general, these directives should only be of interest to embedded systems developers that are counting every byte. Along with any relevant omit flags, you should make sure the compiler is set to build with any “optimize for size” type features enabled.

In order to use most of these omit directives, you need to be building SQLite from the development sources found in the source control tree. Most omit directives won’t work correctly when applied to a source distribution or to the pre-built amalgamation. Also be aware that these compile-time directives are not officially supported, in the sense that they are not part of the official testing chain. For any given version of SQLite, there may be both compile problems and runtime issues if arbitrary sets of omit flags are enabled. Use (and test) at your own risk.

For a full list of the omit compiler directives, see the SQLite website (<http://sqlite.org/compile.html#omitfeatures>).

---

# sqlite3 Command Reference

The `sqlite3` program is a command-line interface, or shell, that allows the user to interactively issue SQL commands and display the results. This can be used to try out queries, test existing databases, debug problems, or just play around and learn SQL. The `sqlite3` program is similar to the `mysql` application for MySQL, the `pgsql` application for PostgreSQL, the `sqlplus` application for Oracle, or the `sqlcmd` application for SQL Server.

Once `sqlite3` has started up and opened a database, the main `sqlite>` prompt is displayed. At this point, SQL statements can be entered. SQL statements should be terminated with a semicolon, and will be executed immediately. The results (if any) will then be displayed. When the database is ready to execute a new statement, the main command prompt will appear.

Longer SQL statements can be entered on multiple lines. In this case, additional lines will display the continue `...>` prompt, which indicates this line is continuation of the previous line or lines. Remember to enter a semicolon to terminate and execute an SQL statement.

The `sqlite3` source code is included in most SQLite distributions as the source file `shell.c`. This, along with the amalgamation files, are all that is required to build the `sqlite3` application. For more information on building `sqlite3`, and what options are available, see “Building” on page 21 and Appendix A.

A number of other third-party, general-purpose, shell-type programs exist for SQLite, including a number of GUI-based applications. See the SQLite website (<http://www.sqlite.org/cvstrac/wiki?p=ManagementTools>) for references to other interactive utilities and tools.

## Command-Line Options

The `sqlite3` tool understands the following command-line format:

```
sqlite3 [options...] [database [SQL_string]]
```

Options are given first, followed by an optional database filename. This database will be opened as the `main` database. If the database file does not exist, it will be created. If no database filename is given (or an empty string is given), a file-backed temporary database will be created. If the database name `:memory:` is given, an in-memory database will be created.

If a database filename is given, an optional SQL string can be provided. This string may consist of one or more SQL statements separated by semicolons. The SQL statements need to be passed as a single argument, so they will most likely need to be enclosed in quotes. If present, `sqlite3` will open the database file, execute the provided SQL statements, and exit. Dot-commands cannot be included in the SQL string. If no SQL string is given, `sqlite3` will provide an interactive prompt and accept either SQL or dot-commands from the terminal interface.

The interactive startup sequence will attempt to locate and open the `.sqliterc` init file in the current user's home directory. If the file exists, lines will be read and executed before any other processing (including the command-line SQL string). The init file may contain both dot-commands and SQL statements. All SQL statements must end in a semicolon. The init file is processed before the command-line options. This allows the command-line options to override any dot-commands that are in the init file.

Recognized command-line options are:

**-bail**

Turns the bail flag on. Batch files will stop processing if an error is encountered. See the [.bail](#) command for more details.

**-batch**

Forces batch-style I/O. This will suppress things like the welcome banner and command prompts.

**-column**

Sets the output mode to *column*. See the [.mode](#) command for more details

**-csv**

Sets the output mode to *csv*. See the [.mode](#) command for more details.

**-echo**

Turns echo mode on. See the [.echo](#) command for more details.

**-header -noheader**

Turns headers on or off. See the [.headers](#) command for more details.

**-init *filename***

If this is an interactive session, use this file as an init file rather than the `.sqliterc` file.

- interactive**  
Forces interactive style I/O. This includes things like the welcome banner and command prompts.
- help**  
Displays a summary of the command-line options and exits.
- html**  
Sets the output mode to *html*. See the [.mode](#) command for more details.
- line**  
Sets the output mode to *line*. See the [.mode](#) command for more details.
- list**  
Sets the output mode to *list*. See the [.mode](#) command for more details.
- nullvalue *string***  
Sets the NULL display string. See the [.nullvalue](#) command for more details.
- separator *string***  
Sets the separator string. See the [.separator](#) command for more details.
- version**  
Prints the SQLite version and exits.

Options will also be recognized if they are prefaced with two dashes, rather than just one.

## Interactive Dot-Commands

This section covers the `sqlite3` dot-commands. Dot-commands control the mode and configuration of the `sqlite3` utility and, in some cases, the underlying SQLite library. Normally, any input to the `sqlite3` utility is assumed to be an SQL statement and is passed to the SQLite library for processing. To distinguish these commands from SQL statements, all of the dot-commands start with a period, or “dot.” Hence, the name.

Unlike SQL statements, dot-commands do not end in a semicolon. The whole command must be given on a single line of input.

It is important to understand that the dot-commands are implemented by the `sqlite3` program itself, and not the underlying SQLite library. Dot-commands cannot be issued to the SQLite statement APIs.

For example, the core SQLite library has no import capability. The functionality of the `.import` command is provided by the `sqlite3` code, using the standard SQLite API calls. If you want to include an import function in your application, you can either write your own, using the standard SQLite API calls, or you can rip the code out of `shell.c` and attempt to adapt it for your own purposes.

Several of the dot-commands turn configuration flags on or off. If a number is given, 0 is false, or off, and all other numbers are taken to be true, or on. The strings `on` and `yes` are recognized to be true, or on, and all other values are taken to be false, or off.

---

## .backup

Perform a low-level copy of a database to file

### Common Usage

`.backup [database_name] filename`

### Description

The `.backup` command performs a low-level copy of an open or attached database to the provided filename. This command is safe to run against an active source database (although it may not succeed). If the database name is not provided, the `main` database will be backed up. This command is frequently used to write-back an active in-memory database to a database file.

This is the opposite of the `.restore` command.

---

## .bail

Stop if an error is encountered

### Common Usage

`.bail switch`

### Description

The `.bail` command controls the error-handling behaviors. It only affects noninteractive sessions, when SQL commands are being read from a file or from standard input. If the bail flag is set, any error will cause the processing to stop.

The default is off.

---

## .databases

List all of the currently attached databases

### Common Usage

`.databases`

### Description

The `.databases` command generates a table of all the currently attached databases. The format of the table is:

Column name	Column type	Meaning
<code>seq</code>	Integer	Database sequence number
<code>name</code>	Text	Logical database name
<code>file</code>	Text	Path and name of database file

The first database (sequence number 0) should always have the name `main`. This is the database that was first opened. The second database (sequence number 1), if present, should always be the `temp` database, where any temporary objects are created. Any attached databases will be listed after that.



---

## **.dump**

Produce an SQL dump file

### **Common Usage**

```
.dump [table-pattern ...]
```

### **Description**

The `.dump` command generates a series of SQL commands suitable to recreate one or more tables from the database. If no parameters are given, every table in the `main` database will be dumped. If one or more parameters are given, only those tables in the `main` database that match the provided `LIKE` patterns will be dumped. To record the `.dump` output to a file, use the `.output` command.

A dump will preserve the values in any `ROWID` alias column (an `INTEGER PRIMARY KEY` column), but it will not preserve more general `ROWID` values.

---

## **.echo**

Turn command echoing on or off

### **Common Usage**

```
.echo switch
```

### **Description**

The `.echo` command turns the SQL command echoing on or off. If set to on, any SQL commands will be printed before being executed. This is most useful for noninteractive sessions.

The default is off.

---

## **.exit**

Quit and exit the `sqlite3` application

### **Common Usage**

```
.exit
```

### **Description**

The `.exit` command quits and exits the `sqlite3` application.

---

## **.explain**

Format output for `EXPLAIN` SQL command

### **Common Usage**

```
.explain [switch]
```

### **Description**

The `.explain` command sets several `sqlite3` parameters (such as mode and column width), making it easier to view the output from any `EXPLAIN` SQL commands. When turned off, the previous settings are restored. If no parameter is given, the explain mode will be turned on. Turning explain on when it is already on resets all shell parameters to the default explain mode.

The default is off.

---

## .headers

Control display of column names and headers

### Common Usage

`.headers switch`

### Description

The `.headers` command controls the display of column names and headers. If on, `sqlite3` will generate a row of column names before displaying any output. In some modes, a separator between the column names and the resulting data will also be displayed.

The default is off.

---

## .help

Display help

### Common Usage

`.help`

### Description

The `.help` command displays each `sqlite3` dot-command along with a brief summary of the command syntax and purpose.

---

## .import

Import an external data file into a table

### Common Usage

`.import filename table-name`

### Description

The `.import` command attempts to import data from an external file and insert it into the specified table. The table must already exist. The file should be a text file with one row per line. Each line should consist of a value separated by the current separator string. The values in each line must match the number and order of columns returned by the command `SELECT * FROM table-name`. The import feature does not understand any form of value quotation or character escape, so any instance of the separator string within a value will cause an error. Any attempt to import a file that uses quotations will result in the quotations being taken as a literal part of the value.

The built-in import functionality is extremely simple, and is not designed to work with robust file formats. If you have a need to frequently import a specific data format (including so-called universal formats, such as CSV), it may be simpler and easier to write your own importer. This can often be done reasonably quickly in the scripting language of your choice, or by writing a read-only external module.

---

## **.indices**

Display all of the indexes associated with one or more tables

### **Common Usage**

```
.indices [table-pattern]
```

### **Description**

The `.indices` command displays the name of different indexes in the `main` database. If no parameter is given, the name of every index will be displayed. If an optional table matching pattern is given, the name of any index associated with a table that matches the provided LIKE pattern will be displayed. Only one table pattern is permitted. Index names will be returned one per line, with no additional information.

---

## **.iotrace**

Direct I/O trace information to a file

### **Common Usage**

```
.iotrace [filename|-]
```

### **Description**

The `.iotrace` command controls I/O trace debugging. If a filename is given, I/O trace will be turned on in the main library and directed to the file. If a single dash is given, I/O trace will be redirected to standard output. If no parameters are given, I/O trace will be disabled.

The `.iotrace` command is only available if both the SQLite library and `sqlite3` are compiled with the directive `SQLITE_ENABLE_IOTRACE`.

---

## **.load**

Load a dynamic extension

### **Common Usage**

```
.load filename [entry-point]
```

### **Description**

The `.load` command attempts to load and link an SQLite dynamic extension. If no entry point is given, the default `sqlite3_extension_init` name will be used.

Extensions that redefine existing SQL functions (including built-in functions) must be loaded using this command. Using the SQL function `load_extension()` will not work, as an extension cannot redefine an existing function while an SQL statement is being processed (for example, the statement executing the SQL function `load_extension()`).

---

## .log

Turn logging on or off

### Common Usage

`.log (filename|stdout|stderr|off)`

### Description

The `.log` command designates an output file for messages sent to `sqlite3_log()`. The SQLite library logs most error conditions, to assist with debugging. Custom extensions (including custom SQL functions, collations, and virtual tables) may also log messages.

---

## .mode

Set the output mode

### Common Usage

`.mode (column[s]|csv|html|insert|line[s]|list|tabs|tcl) [table-name]`

### Description

The `.mode` command sets the output mode. This determines how the output data is formatted and presented. The optional table name is only used by the `insert` mode. The default mode is `list`. Supported modes include:

#### *column*

Output is in a tabular format, with one row per line. The width of each column is defined by the values provided by the `.width` command. Output will be clipped to fit into the column width. If headers are on, the first two lines will be the column names, followed by separator dashes. In most cases, this is the easiest format for humans to read, assuming the column widths are set to something useful.

#### *csv*

Output is in comma-separated values, with one row per line. Each value is separated by a single comma character with no trailing space. If headers are on, the first line will be the set of column names. If a value contains a comma, the value will be enclosed in double quotes. If the value contains a double quote character, the SQL rules for escaping quotes will be used and the literal double quote will be replaced with two double quote characters in sequence. This is not what many CSV importers expect, however.

#### *html*

Output is in an HTML table format. Each database row will be output as a `<tr>` element (table row). If headers are on, the first table row element will contain the column names. For older versions of HTML, the output is suitable to place within a `<table>` element.

#### *insert*

Output is a series of SQL `INSERT` statements. If a table name is given as part of the `.mode` command, that name will be used as the table in the `INSERT` statement. If no table name is given, the name `table` will be used. The header flag has no effect in this mode.

*line*

Output is one value per line in the format `column_name = value` (with some possible leading white space before the column name). Each row is separated by a blank line. The header flag has no effect in this mode.

*list*

Output consists of a sequence of values, with one row per line. Each value is separated by the current separator string (default is `|`, a bar or pipe). No separator will appear after the final value. There is no provision to quote or escape the separator string if it appears in a value. If headers are on, the first line will contain the column names. In general, this is the easiest format to parse, assuming a unique separator is used.

*tabs*

Output is in tab-separated values, with one row per line. There is no provision to quote or escape tab characters included in values. If headers are on, the first line will contain the column names.

*tcl*

Output consists of a sequence of values, with one row per line. Each value is separated by the current separator string (default is `|`, a bar or pipe). A separator will be included after the final value. All values will be put in double quotes, although there is no provision to quote or escape double quote characters included in values. If headers are on, the first line will contain the column names. This mode is designed to be used with the Tcl scripting language.

If the output of `sqlite3` is fed directly into a script or other automated system, be very sure you understand how values are delimited and that there are provisions to quote, escape, or avoid any separators within the returned values. Of specific note, be aware that the CSV format is not nearly as universal as many people think. While the format works well for numbers and simple data, if text values require quoting or escape sequences, compatibility should be tested before being used.

---

## **.nullvalue**

Set the string used to represent a NULL output

### **Common Usage**

`.nullvalue string`

### **Description**

The `.nullvalue` command sets the string used to represent NULL outputs in any output mode other than `insert`. The default is an empty string.

---

## **.output**

Set the output destination

### **Common Usage**

`.output (filename|stdout)`

### **Description**

The `.output` command sets the output destination. By default, any command output is directed to the terminal interface (in the case of interactive sessions) or the program output (in the case of batch sessions). Given a filename, the `.output` command will redirect any command output to a file. The file will be created if it does not exist. If the file does exist, it will be truncated. If the output is being redirected to a file, it will not also be displayed to the terminal. Commands and command prompts will not be output to the file, making this a suitable way to generate SQL dump files using the `.dump` command.

To reset the output to the terminal interface, set the output to `stdout` (standard output).

---

## **.prompt**

Set the command prompt

### **Common Usage**

`.prompt main [continue]`

### **Description**

The `.prompt` command modifies the `sqlite3` command prompts. The main prompt is used for most commands, while the continue prompt is used for multiline SQL commands.

The default main prompt is `sqlite>` and the default continue prompt is `...>`.

---

## **.quit**

Quit and exit the `sqlite3` application

### **Common Usage**

`.quit`

### **Description**

The `.quit` command quits and exits the `sqlite3` application.

---

## **.read**

Execute SQL commands from a file

### **Common Usage**

`.read filename`

### **Description**

The `.read` command reads and executes dot-commands and SQL statements from a file.

---

## **.restore**

Perform a low-level copy of a database file to a database

### **Common Usage**

```
.restore [database_name] filename
```

### **Description**

The `.restore` command performs a low-level copy of a database file into an open or attached database. If the database name is not provided, the main database will be populated. This command is frequently used to populate an active in-memory database from a database file. This command is safe to run against an active source database (although it may not succeed).

This is the opposite of the `.backup` command.

---

## **.schema**

Display SQL creation commands for schema

### **Common Usage**

```
.schema [table-pattern]
```

### **Description**

The `.schema` command displays the SQL commands used to create the schema (tables, views, indexes, etc.). If no parameter is given, the `CREATE` command for every object in the `main` and `temp` databases will be displayed. A single parameter can also be given, in which case only those objects associated with tables that match the `LIKE` pattern will be displayed.

---

## **.separator**

Define the string used as a column separator

### **Common Usage**

```
.separator string
```

### **Description**

The `.separator` command defines the separator string used between columns when the list output mode is set.

The list mode is the default mode and the default separator string is `|` (a pipe or bar).

---

## **.show**

Display current `sqlite3` settings

### **Common Usage**

```
.show
```

### **Description**

The `.show` command displays the current values for a small number of the `sqlite3` settings, including the state of the `echo` flag, the `explain` flag, the `headers` flag, the current output mode, the `NULL` string, the output destination, the separator string, and any configured column widths.

---

## **.tables**

Display the list of table and view names

### **Common Usage**

`.tables [table-pattern]`

### **Description**

The `.tables` command displays the list of names for all of the table and view objects that are found in the `main` and `temp` databases.

---

## **.timeout**

Set a lock retry timer

### **Common Usage**

`.timeout milliseconds`

### **Description**

The `.timeout` command is used to set a retry timer. If a timer value is set and a locked database is encountered, rather than immediately returning a “database locked” error, in most cases SQLite will keep attempting to reacquire the lock until the timer expires.

A value of 0 or less disables the timeout value.

---

## **.timer**

Enable or disable CPU time measurements

### **Common Usage**

`.timer switch`

### **Description**

The `.timer` command can be used to enable or disable CPU time measurements. If enabled, SQLite will track and display the user time and system time required to process each request.

---

## **.width**

Set the display width for each column

### **Common Usage**

`.width numb [numb ...]`

### **Description**

The `.width` command is used to set the default width of each column. The width values are used to format the display when the output mode is set to `column`. The first value is used for the width of the first column, the second value is used for the second column, and so on. If no values have been set, a column width of 10 will be used.

Up to 100 column widths can be specified.



---

# SQLite SQL Command Reference

This appendix lists the SQL commands and syntax that are supported by SQLite. SQL statements consist of a single command and any required parameters. Command statements are separated by a semicolon. Technically, standalone statements do not need to be terminated with a semicolon, but most interactive environments require the use of a semicolon to indicate that the current command statement is complete and should be executed. For example, the C API `sqlite3_exec()` does not require that command statements end with a semicolon, but interactive use of `sqlite3` requires ending each statement with a semicolon.

In most situations where a table name is called for, a view name can be used instead. As noted in the syntax diagrams, in most instances where any object identifier is used (table name, view name, etc.), the name can be qualified with a logical database name to prevent any ambiguity between objects in different databases that share a similar name (see [ATTACH DATABASE](#) in this appendix). If the object is unqualified, it will be searched for in the `temp` database, followed by the `main` database, followed by each attached database, in order. If an unqualified identifier appears in a `CREATE` statement, the object will be created in the main database, unless the statement contains some type of `CREATE TEMPORARY` syntax. Object identifiers that use nonstandard characters must be quoted. See “[Basic Syntax](#)” on page 30 for more info.

The `SELECT`, `UPDATE`, and `DELETE` commands contain clauses that are used to define search criteria on table rows. These table references can include the nonstandard phrases `INDEXED BY` or `NOT INDEXED`, to indicate whether the query optimizer should (or should not) attempt to use an index to satisfy the search condition. These extensions are included in SQLite to assist with testing, debugging, and hand-tuning queries. Their use in production code is not recommended, and therefore they are not included in the syntax diagrams or command explanations found in this appendix. For more information, see the SQLite website ([http://www.sqlite.org/lang\\_indexedby.html](http://www.sqlite.org/lang_indexedby.html)).

Finally, be aware that the syntax diagrams presented with each command should not be taken as the definitive specification for the full command syntax. Some rarely used, nonstandard syntax (such as the `INDEXED BY` extension discussed in the previous paragraph) are not included in these diagrams. Similarly, there are possible syntax combinations that the diagrams will indicate are possible, but do not actually form logical statements. For example, according to the syntax diagrams, a `JOIN` operator can contain both a prefixed `NATURAL` condition, as well as a trailing `ON` or `USING` condition. This isn't possible in practice, as a join is limited to only one type of condition. While it would have been possible to present the diagram with only the allowed syntax, the diagram would have become much larger and much more complex. In such situations, it was decided that making the diagram easy to understand was more important than making it walk an absolute line on what was allowed or not allowed. Thankfully, such situations are reasonably rare. Just don't assume that because the parser can parse it means that the command makes sense to the database engine.

## SQLite SQL Commands

The following SQL commands and syntax are supported by SQLite.

---

### ALTER TABLE

Modify an existing table

#### Syntax

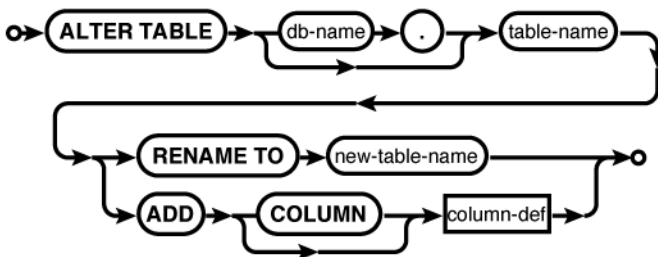

#### Common Usage

```
ALTER TABLE database_name.table_name RENAME TO new_table_name;
ALTER TABLE database_name.table_name ADD COLUMN column_def...;
```

#### Description

The `ALTER TABLE` command modifies an existing table without performing a full dump and reload of the data. The SQLite version of `ALTER TABLE` supports two basic operations. The `RENAME` variant is used to change the name of a table, while `ADD COLUMN` is used to add a new column to an existing table. Both versions of the `ALTER TABLE` command will retain any existing data in the table.

## RENAME

The **RENAME** variant is used to “move” or rename an existing table. An **ALTER TABLE...RENAME** command can only modify a table in place, it cannot be used to move a table to another database. A database name can be provided when specifying the original table name, but only the table name should be given when specifying the new table name.

Indexes and triggers associated with the table will remain with the table under the new name. If foreign key support is enabled, any foreign keys that reference this table will also be updated.

View definitions and trigger statements that reference the table by name will *not* be modified. These statements must be dropped and recreated, or a replacement table must be created.

## ADD COLUMN

The **ADD COLUMN** variant is used to add a new column to the end of a table definition. New columns must always go at the end of the table definition. The existing table rows are not actually modified, meaning that the added columns are implied until a row is modified. This means the **ALTER TABLE...ADD COLUMN** command is quite fast, even for large tables, but it also means there are some limitations on the columns that can be added.

The added column:

- Cannot have a **PRIMARY KEY** constraint
- Cannot have a **UNIQUE** constraint
- Must have a literal, non-NULL default value if a **NOT NULL** constraint is given
- Cannot have a default of **CURRENT\_TIME**, **CURRENT\_DATE**, or **CURRENT\_TIMESTAMP**

If foreign key constraints are enabled and the added column is defined as a foreign key (it has a **REFERENCES** clause), the new column must have a default of **NULL**.

Additionally, if the new column has a **CHECK** constraint, that constraint will only be applied to new values. This can lead to data that is inconsistent with the **CHECK**.

There is no way to remove a column once it has been added.

## See Also

[CREATE TABLE](#)

---

## ANALYZE

Compute index meta-data

### Syntax

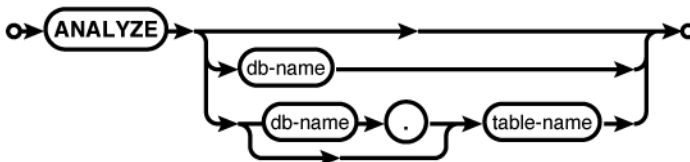

## Common Usage

```
ANALYZE;  
ANALYZE database_name;  
ANALYZE database_name.table_name;
```

## Description

The `ANALYZE` command computes and records statistical data about database indexes. If available, this data is used by the query optimizer to compute the most efficient query plan.

If no parameters are given, statistics will be computed for all indexes in all attached databases. You can also limit analysis to just those indexes in a specific database, or just those indexes associated with a specific table.

The statistical data is *not* automatically updated as the index values change. If the contents or distribution of an index changes significantly, it would be wise to reanalyze the appropriate database or table. Another option would be to simply delete the statistical data, as no data is usually better than incorrect data.

Data generated by `ANALYZE` is stored in one or more tables named `sqlite_stat#`, starting with `sqlite_stat1`. These tables cannot be manually dropped, but the data inside can be altered with standard SQL commands. Generally, this is not recommended, except to delete any `ANALYZE` data that is no longer valid or desired.

By default, the `ANALYZE` command generates data on the number of entries in an index, as well as the ratio of unique values to total values. This ratio is computed by dividing the total number of entries by the number of unique values, rounding up to the nearest integer. This data is used to compute the cost difference between a full-table scan and an indexed lookup.

If SQLite is compiled with the `SQLITE_ENABLE_STAT2` directive, then `ANALYZE` will also generate an `sqlite_stat2` table that contains a histogram of the index distribution. This is used to compute the cost of targeting a range of values.

There is one known issue with the `ANALYZE` command. When generating the `sqlite_stat1` table, `ANALYZE` must calculate the number of unique values in an index. To accomplish this, the `ANALYZE` command uses the standard SQL test for equivalence between index values. This means that if a single-column index contains multiple `NULL` entries, they will each be considered a nonequivalent, unique value (since `NULL != NULL`). As a result, if an index contains a large number of `NULL` values, the `ANALYZE` data will incorrectly consider the index to have more uniqueness than it actually does. This can incorrectly influence the optimizer to pick an index-based lookup when a full-table scan would be less expensive. Due to this behavior, if an index contains a noticeable percentage of `NULL` entries (say, 10 to 15% or more) and it is common to ask for all of the `NULL` (or non-`NULL`) rows, it is recommended that the `ANALYZE` data for that index is discarded.

## See Also

[CREATE INDEX](#), [SELECT](#)

## ATTACH DATABASE

Attach a database file

### Syntax



### Common Usage

```
ATTACH DATABASE 'filename' AS database_name;
```

### Description

The `ATTACH DATABASE` command associates the database file *filename* with the current database connection under the logical database name *database\_name*. If the database file *filename* does not exist, it will be created. Once attached, all references to a specific database are done via the logical database name, not the filename. All database names must be unique, but (when shared cache mode is not enabled) attaching the same filename multiple times under different database names is properly supported.

The database name `main` is reserved for the primary database (the one that was used to create the database connection). The database name `temp` is reserved for the database that holds temporary tables and other temporary data objects. Both of these database names exist for every database connection.

If the filename `:memory:` is given, a new in-memory database will be created and attached. Multiple in-memory databases can be attached, but they will each be unique. If an empty filename is given ( `' '` ), a temporary file-backed database will be created. Like an in-memory database, each database is unique and all temporary databases are automatically deleted when they are closed. Unlike an in-memory database, file-based temporary databases can grow to large sizes without consuming excessive memory.

All databases attached to a database connection must share the same text encoding as the `main` database. If you attempt to attach a database that has a different text encoding, an SQLite logic error will be returned.

If the `main` database was opened with `sqlite3_open_v2()`, each attached database will be opened with the same flags. If the `main` database was opened read-only, all attached databases will also be read-only.

Associating more than one database to the same database connection enables the execution of SQL statements that reference tables from different database files. Transactions that involve multiple databases are atomic, assuming the main database is not an in-memory database. In that case, transactions within a given database file continue to be atomic, but operations that bridge database files may not be atomic.

If any write operations are performed on any database, a master journal file will be created in association with the `main` database. If the `main` database is located in a read-only area, the master journal file cannot be created and the operation will fail. If some databases are read-only and some are read/write, make sure the `main` database is one of the databases that is located in a read/write area.

## BEGIN TRANSACTION

Any place SQLite expects a table name, it will accept the format *database\_name.table\_name*. This can be used to refer to a table within a specific database that might otherwise be ambiguous.

### See Also

[DETACH DATABASE](#), [encoding](#) [PRAGMA, Ap F], [temp\\_store](#) [PRAGMA, Ap F], [sqlite3\\_open\(\)](#) [C API, Ap G]

---

## BEGIN TRANSACTION

Open an explicit transaction

### Syntax

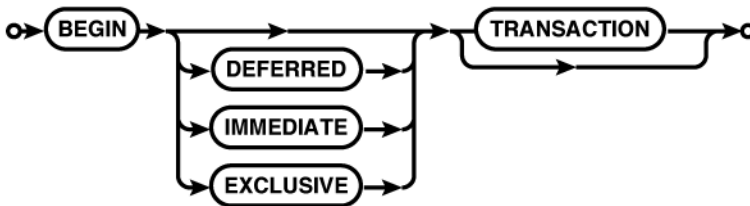

### Common Usage

```
BEGIN;
BEGIN EXCLUSIVE TRANSACTION;
```

### Description

The `BEGIN TRANSACTION` command starts an explicit transaction. Once started, an explicit transaction will remain open until the transaction is either committed using `COMMIT TRANSACTION`, or rolled back using `ROLLBACK TRANSACTION`. Transactions are used to group multiple discrete commands (such as a sequence of `INSERT` commands that insert rows into cross-referenced tables) into a single logical command.

Transactions are ACID-compliant, in that they are atomic, consistent, isolated, and durable. They're an important part of correct database design and database use. For more information, see [“Transaction Control Language” on page 51](#).

All changes and modifications to a database are done within a transaction. Normally, SQLite is in autocommit mode. In this mode, each and every statement that might modify the database is automatically wrapped in its own transaction. Each command begins a transaction, executes the given command statement, and attempts to commit the changes. If any error occurs, the wrapper transaction is rolled back.

The `BEGIN` command turns off autocommit mode, opening a transaction and leaving it open until it is explicitly committed or rolled back. This allows multiple commands (and multiple modifications) to be packaged into a single transaction. Once a `COMMIT` or `ROLLBACK` is issued, the database connection is put back into autocommit mode.

Transactions cannot be nested. For that functionality, use `SAVEPOINT`. Executing a `BEGIN` command while the database connection is already in a transaction will result in an error, but will not change the state of the preexisting transaction.

There is a significant cost associated with committing a transaction. In autocommit mode, this cost is seen by every command. In some situations, it can be prudent to wrap several commands into a single transaction. This helps amortize the transaction cost across several statements. When doing large operations, such as bulk inserts, it is not unusual to wrap several hundred, or even a thousand or more `INSERT` commands into a single transaction. The only caution in doing this is that a single error can cause the whole transaction to rollback, so you need to be prepared to re-create all of the rolled back `INSERT` statements.

In SQLite, transactions are controlled by locks. You can specify the locking behavior you want with the modifier `DEFERRED`, `IMMEDIATE`, or `EXCLUSIVE`. The default mode is `DEFERRED`, in which no locks are acquired until they are needed. This allows the highest level of concurrency, but also means the transaction may find itself needing a lock it cannot acquire, and may require a rollback. The `IMMEDIATE` mode attempts to immediately acquire the reserved lock, allowing other connections to continue to read from the database, but reserving the right to elevate itself to write status at any time. Starting an `EXCLUSIVE` transaction will attempt to grab the exclusive lock, allowing full access to the database, but denying access by any other database connection. Higher locking levels means greater certainty that a transaction can be successfully committed at the cost of lower levels of concurrency.

For more information on SQLite's locking and concurrency model, see <http://sqlite.org/lockingv3.html>.

### See Also

[COMMIT TRANSACTION](#), [ROLLBACK TRANSACTION](#), [SAVEPOINT](#), [RELEASE SAVEPOINT](#)

---

## COMMIT TRANSACTION

Finish and commit a transaction

### Syntax

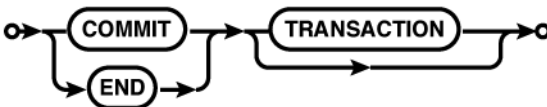

### Common Usage

```
COMMIT;
```

### Description

The `COMMIT TRANSACTION` command attempts to close and commit any changes made during the current transaction. The alias `END TRANSACTION` may also be used. If a `COMMIT` command is made while SQLite is in autocommit mode, an error will be issued.

## CREATE INDEX

If the `COMMIT` is successful, the database will be synchronized and any modifications made within the transaction will become a permanent part of the database record and the database connection will be put back in autocommit mode.

If the commit is not successful, the transaction may or may not be rolled back, depending on the type of error. If the transaction is not rolled back, you can usually just reissue the `COMMIT` command. If the transaction is rolled back, all modifications made as part of the transaction are lost. You can determine the specific state of the database connection using the `sqlite3_get_autocommit()` API call, or by trying to issue the `BEGIN` command. If the database returns a logical error as a result of the `BEGIN` command, the database is still in a valid transaction. You can also issue the `ROLLBACK` command, which will either roll back the transaction if it is still in place, or return an error if the transaction was already rolled back.

There is a significant cost associated with committing a transaction. See [BEGIN TRANSACTION](#) for more details on how to reduce this cost.

### See Also

[BEGIN TRANSACTION](#), [ROLLBACK TRANSACTION](#), [END TRANSACTION](#), [sqlite3\\_get\\_autocommit\(\)](#) [C API, Ap G]

---

## CREATE INDEX

Define and create a new table index

### Syntax

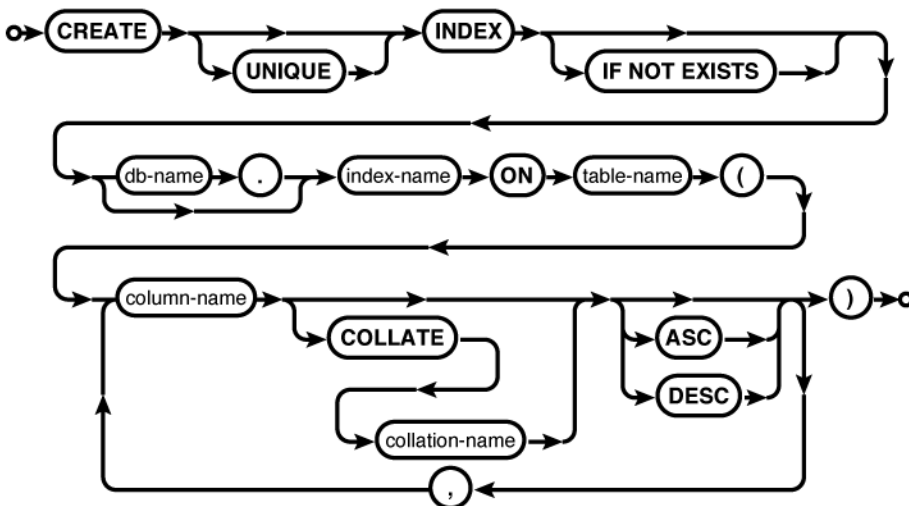

### Common Usage

```
CREATE INDEX index_name ON table_name ( column_name COLLATE NOCASE );
CREATE UNIQUE INDEX database_name.index_name ON table_name ( col1, col2, ... );
```



## Description

The `CREATE INDEX` command creates a user-defined index. Upon creation, the index is populated from the existing table data. Once created, the index will be automatically maintained, so that modifications to the referenced table will be reflected in the index. The query optimizer will automatically consider any indexes that have been created. Indexes cannot be created on virtual tables or views.

An index can reference multiple columns, but all of the columns must be from the same table. In the case of multicolumn indexes, the index will be built in the same order as the column listing. For performance-related indexes, the column ordering can be very important. See “[Order Matters](#)” on page 109 for more details. The table must be in the same database as the index. To create an index on a temporary table, create the index in the `temp` database.

If a table is dropped, all associated indexes are also dropped. A user-defined index may also be explicitly dropped with the `DROP INDEX` command.

If the optional `UNIQUE` clause is included, the index will not allow inclusion of equivalent index entries. An index entry includes the whole set of indexed columns, taken as a group, so you may still find duplicate column values in a unique multicolumn index. As usual, `NULL` entries are considered unique from each other, so multiple `NULL` entries may exist even in a unique single-column index.

An optional collation can be provided for each column. By default, the column’s native collation will be used. If an alternate collation is provided, the index can only be used in queries that also specify that collation.

Additionally, each indexed column can specify an ascending (`ASC`) or descending (`DESC`) sort order. By default, all indexed columns will be sorted in an ascending order. Use of descending indexes requires a modern file format. If the database is still using the legacy file format, descending indexes will not be supported and the `DESC` keyword will be silently ignored.

SQLite indexes include a full copy of the indexed data. Be cautious of your database size when indexing columns that consist of large text or `BLOB` values. Generally, indexes should only be created on columns that have a relatively unique set of values. If any single value appears in more than 10% to 15% of the rows, an index is usually inadvisable. It is almost always unwise to index a Boolean column, or any similar column that holds relatively few values. There is a cost associated with maintaining indexes, so they should only be created when they serve some purpose.

Creating an index that already exists will normally generate an error. If the optional `IF NOT EXISTS` clause is provided, this error is silently ignored. This leaves the original definition (and data) in place.

## See Also

[DROP INDEX](#), [ANALYZE](#), [REINDEX](#), [CREATE TABLE](#), [COLLATE](#) [SQL Expr, Ap D]

# CREATE TABLE

Define and create a new table

## Syntax

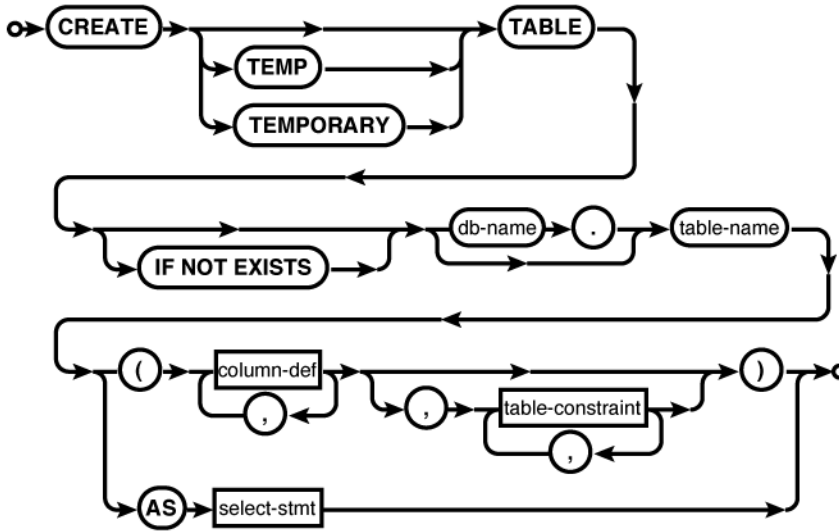

### column-def:

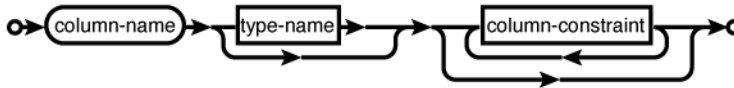

### type-name:

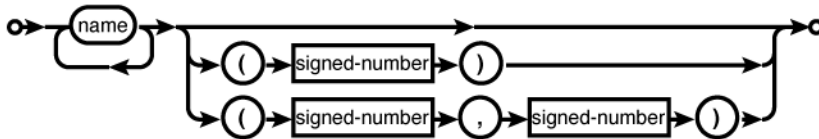

column-constraint:

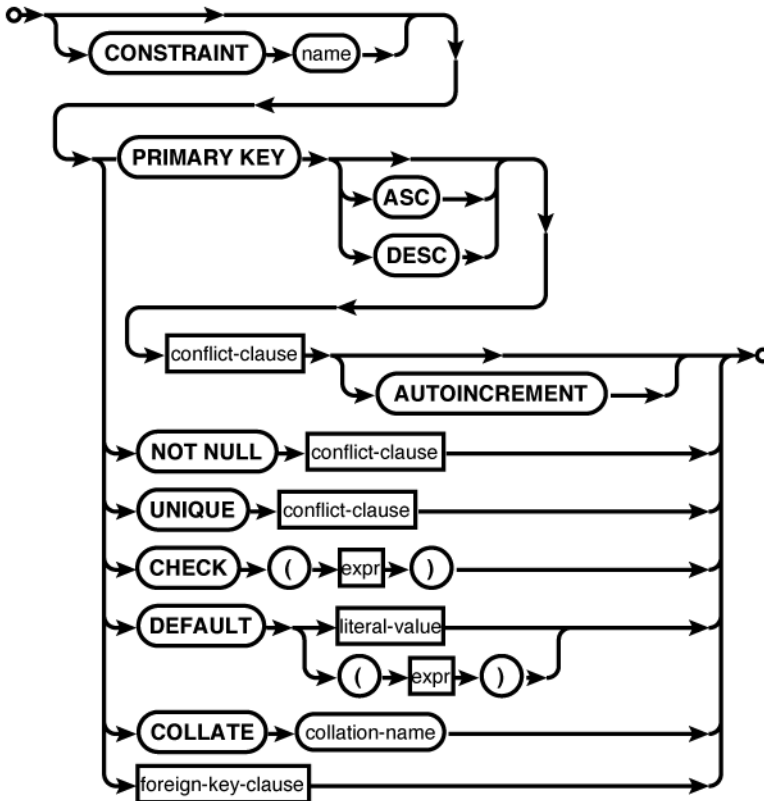

CREATE TABLE

table-constraint:

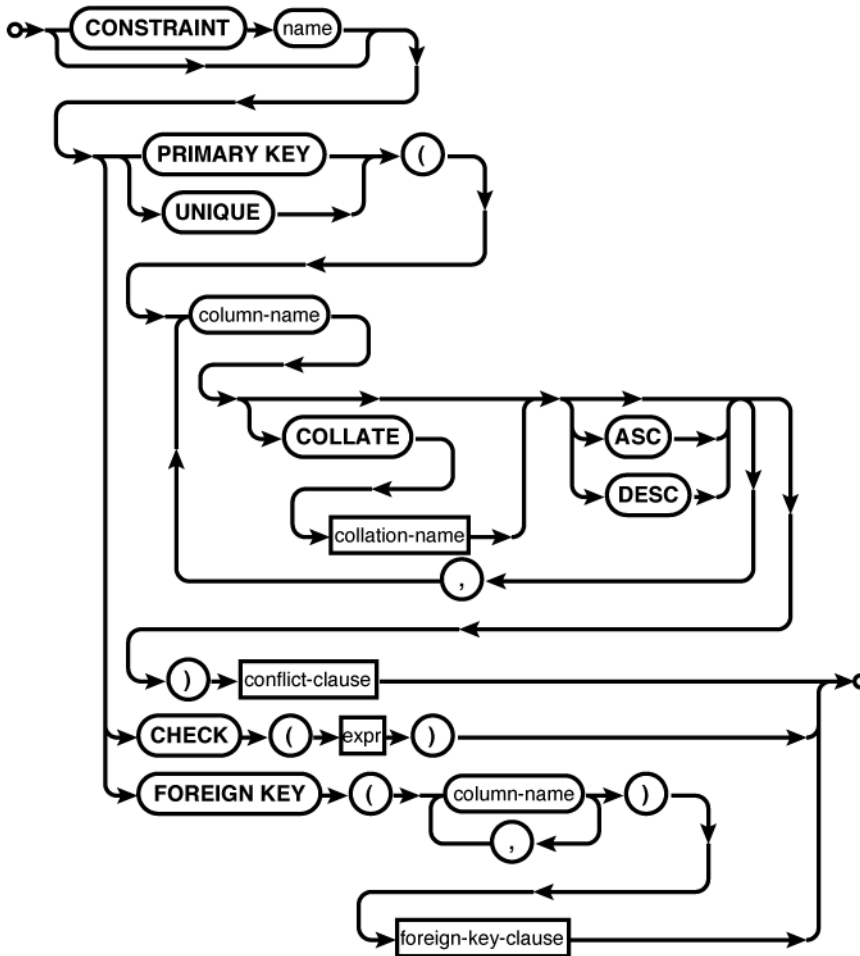

foreign-key-clause:

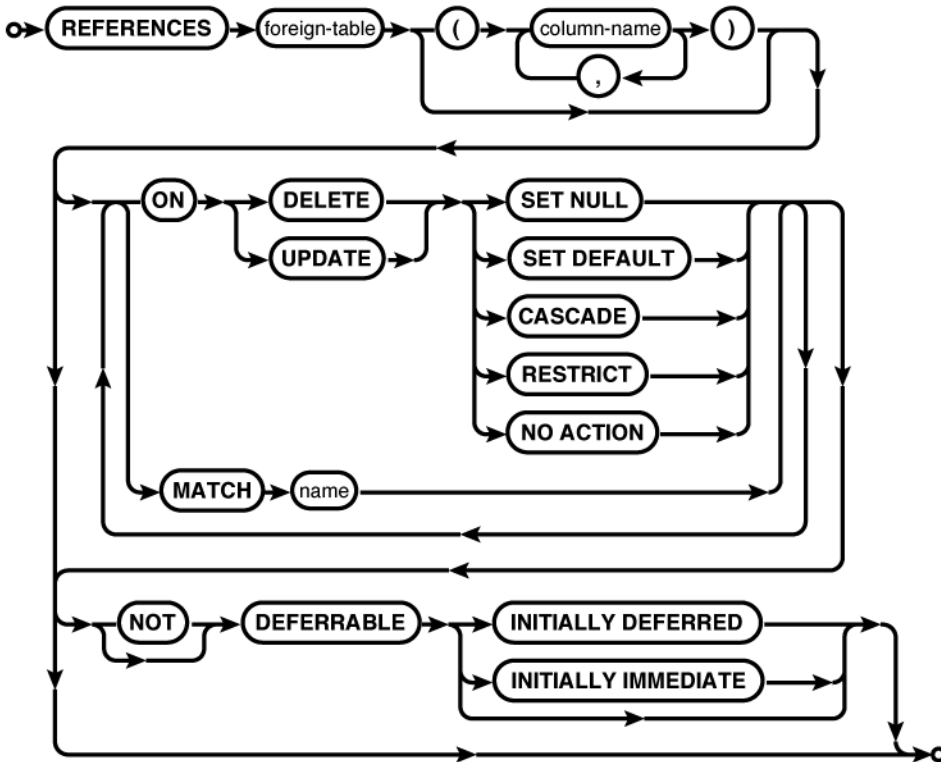

conflict-clause:

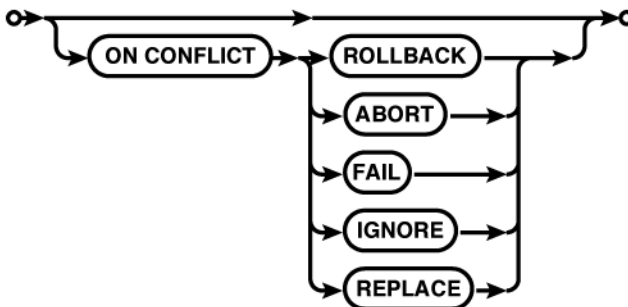

## CREATE TABLE

### Common Usage

```
CREATE TABLE database_name.table_name ( c1_name c1_type, c2_name c2_type... );
CREATE TABLE database_name.table_name AS SELECT * FROM... ;
CREATE TABLE tbl ( a, b, c );
CREATE TABLE people ( people_id INTEGER PRIMARY KEY, name TEXT );
CREATE TABLE employee (
    employee_id INTEGER PRIMARY KEY NOT NULL,
    name TEXT NOT NULL,
    start_date TEXT NOT NULL DEFAULT CURRENT_DATE,
    parking_spot INTEGER UNIQUE );
```

### Description

The `CREATE TABLE` command is used to define a new table. It is one of the most complex SQL commands understood by SQLite, though nearly all of the syntax is optional.

A new table can be created in a specific database by qualifying the table name with an explicit database name. If one of the optional keywords `TEMP` or `TEMPORARY` is present, any database name given as part of the table name will be ignored, and the new table will be created in the `temp` database.

Creating a table that already exists will normally generate an error. If the optional `IF NOT EXISTS` clause is provided, this error is silently ignored. This leaves the original definition (and data) in place.

There are two variations of `CREATE TABLE`. The difference is in how the columns are defined. The least common variation uses a simple `AS SELECT` subquery to define the structure and initial contents of the table. The number of columns and the column names will be taken from the result set of the subquery. The rows of the result set will be loaded into the table as part of the table creation process. Because this variation provides no way to define column affinities (typical datatypes), keys, or constraints, it is typically limited to defining “quick and dirty” temporary tables. To quickly create and load structured data, it is often better to create a table using the standard notation and then use an `INSERT...SELECT` command to load the table. The standard notation explicitly defines a list of columns and table constraints.

### Basic format

The most common way to define a table structure is to provide a list of column definitions. Column definitions consist of a name and a type, plus zero or more column-level constraint definitions.

The list of column definitions is followed by a list of table-level constraints. For the most part, column-level constraints and table-level constraints are very similar. The main difference is that column constraints apply to the values found in a single column, while table constraints can deal with one or more columns. It is possible to define most column constraints as table-level constraints that only reference a single column. For example, a multicolumn primary key must be defined as a table constraint, but a single-column primary key can be defined as either a table constraint or a column constraint.

The column name is a standard identifier. If nonstandard characters (such as a space or a hyphen) are used, the identifier must be quoted in the `CREATE TABLE` statement as well as any other reference.

The column name is followed by a type indicator. In SQLite, the type is optional, since nearly any column can hold any datatype. SQLite columns do not technically have types, but rather have type affinities. An affinity describes the most favored type for the column and allows SQLite to do implicit conversions in some cases. An affinity does not limit a column to a specific type, however. The use of affinities also accounts for the fact that the type format is extremely flexible, allowing type names from nearly any dialect of SQL. For more specifics on how type affinities are determined and used, see [“Column types” on page 36](#).

If you want to make sure a specific affinity is used, the most straightforward type names are `INT`, `REAL`, `TEXT`, or `BLOB`. SQLite does not use precision or size limits internally. All integer values are signed 64-bit values, all floating-point values are 64-bit values, and all text and `BLOB` values are variable length.

All tables have an implied root column, known as `ROWID`, that is used internally by the database to index and store the database table structure. This column is not normally displayed or returned in queries, but can be accessed directly using the name `ROWID`, `_ROWID_`, or `OID`. The alternate names are provided for compatibility with other database engines. Generally, `ROWID` values should never be used or manipulated directly, nor should the `ROWID` column be directly used as a table key. To use a `ROWID` as a key value, it should be aliased to a user-defined column. See [“PRIMARY KEY constraint” on page 314](#).

### Column constraints

Each column definition can include zero or more column constraints. Column constraints follow the column type indicator; there is no comma or other delimiter between basic column definitions and the column constraints. The constraints can be given in any order.

Most of the column constraints are easy to understand. The `PRIMARY KEY` constraint is a bit unique, however, and is discussed below, in its own section.

The `NOT NULL` constraint prohibits the column from containing `NULL` entries. The `UNIQUE` constraint requires all the values of the column to be unique. An automatic unique index will be created on the column to enforce this constraint. Be aware that `UNIQUE` does not imply `NOT NULL`, and unique columns are allowed to have more than one `NULL` entry. This means there is a tendency for columns with a `UNIQUE` constraint to also have a `NOT NULL` constraint.

The `CHECK` constraint provides an arbitrary user-defined expression that must remain true. The expression can safely access any column in the row. The `CHECK` constraint is very useful to enforce specific data formats, ranges or values, or even specific datatypes. For example, if you want to be absolutely sure nothing but integer values are entered into a column, you can add a constraint such as:

```
CHECK ( typeof( column_name ) == 'integer' )
```

The `DEFAULT` constraint defines a default value for the column. This value is used when an `INSERT` statement does not include a specific value for this column. A `DEFAULT` can either be a literal value or, if enclosed in parentheses, an expression. Any expression must evaluate to a constant value. You can also use the special values `CURRENT_TIME`, `CURRENT_DATE`, or `CURRENT_TIMESTAMP`. These will insert an appropriate text value indicating the time the row was first created. If no `DEFAULT` constraint is given, the default value will be `NULL`.

The `COLLATION` constraint is used to assign a specific collation to a column. This not only defines the sort order for the column, it also defines how values are tested for equality (which is important for things such as `UNIQUE` constraints). SQLite includes three built-in collations: `BINARY` (the default), `NOCASE`, and `RTRIM`. `BINARY` treats all values as binary data that must match exactly. `NOCASE` is similar to binary, only it is case-insensitive for ASCII text values (in specific, character codes < 128). Also included is `RTRIM` (right-trim), which is like `BINARY`, but will trim any trailing whitespace from `TEXT` values before doing comparisons.

Finally, columns can contain a `REFERENCES` foreign key constraint. If given as a column constraint, the foreign table reference can contain no more than one foreign column name. If no column references are given, the foreign table must have a single-column primary key. For more information on foreign keys, see the section “[Foreign Keys](#)” on page 89. Note that a column-level foreign key constraint does not actually contain the words `FOREIGN KEY`. That syntax is for table-level foreign key constraints.

### Table constraints

Generally, the table-level constraints are the same as the column-level constraints, except that they operate across more than one column. In most cases, table-level constraints have similar syntax to their column-level counterparts, with the addition of a list of columns that are applied to the constraint.

The `UNIQUE` table constraint requires that each group of column values must be `UNIQUE` from all the other groups within the table. In the case of a multicolumn `UNIQUE` constraint, any individual column is allowed to have duplicate values, it is only the group of column values, taken as a whole, that must remain unique. Both `UNIQUE` and `PRIMARY KEY` multicolumn constraints can define individual column collations and orderings that are different from the individual column collations.

The table-level `CHECK` constraint is identical to the column-level `CHECK` constraint. Both forms are allowed to use an arbitrary expression that references any column in the row.

Finally, multicolumn foreign keys are defined with the `FOREIGN KEY` constraint. The list of local table columns must be the same size, and in the same order, as the foreign column list provided by the `REFERENCES` clause. For more information on foreign keys, see “[Foreign Keys](#)” on page 89.

### PRIMARY KEY constraint

The `PRIMARY KEY` constraint is used to define the primary key (or PK) for the table. From a database design and theory standpoint, it is desirable for every table to have a primary key. The primary key defines the core purpose of the table by defining the specific data points that make each row a unique and complete record.

From a practical standpoint, SQL does not require a table to have a PK. In fact, SQL does not require that rows within a table be unique. Nonetheless, there are some advantages to defining a primary key, especially when using foreign keys. In most cases a foreign key in one table will refer to the primary key of another table, and explicitly defining a primary key can make it easier to establish this relationship. SQLite also provides some additional features for single-column primary keys.

There can be only one `PRIMARY KEY` constraint per table. It can be defined at either the column level or the table level, but each table can have only one. A `PRIMARY KEY` constraint implies a



**UNIQUE** constraint. As with a standalone **UNIQUE** constraint, this will cause the creation of an automatic unique index (with one exception). In most database systems, **PRIMARY KEY** also implies **NOT NULL**, but due to a long-standing bug, SQLite allows the use of **NULL** entries in a primary key column. For proper behavior, be sure to define at least one column of the primary key to be **NOT NULL**.

If a column has the type identifier **INTEGER** (it can be upper- or lowercase, but must be the exact word “integer”), an ascending collation (the default), and has a single-column **PRIMARY KEY** constraint, then that column will become an alias for the **ROWID** column. Behind the scenes, this makes an **INTEGER PRIMARY KEY** column the root column, used internally to index and store the database table. Using a **ROWID** alias allows for very fast row access without requiring a secondary index. Additionally, SQLite will automatically assign an unused **ROWID** value to any row that is inserted without an explicit column value.

Columns defined as **INTEGER PRIMARY KEY** can really truly hold only integer values. Additionally, unlike other primary key columns, they have an inherent **NOT NULL** constraint. Default values are assigned using the standard **ROWID** allocation algorithm. This algorithm will automatically assign a value that is one larger than the largest currently used **ROWID** value. If the maximum value is met, a random (unused) **ROWID** value will be chosen. As rows are added and removed from a table, this allows **ROWID** values to be recycled.

While recycling values is not a problem for internal **ROWID** values, it can cause problems for reference values that might be lurking elsewhere in the database. To avoid problems, the keyword **AUTOINCREMENT** can be used with an **INTEGER PRIMARY KEY** to indicate that automatically generated values should not be recycled. Default values assigned by **AUTOINCREMENT** will be one larger than the largest **ROWID** value that was ever used, but don't depend on each and every value being used. If the maximum value is reached, an error is returned.

When using a **ROWID** alias to automatically generate keys, it is a common practice to insert a new row and call the SQL function `last_insert_rowid()`, or the C function `sqlite3_last_insert_rowid()`, to retrieve the **ROWID** value that was just assigned. This value can be used to insert or update rows that reference the newly inserted row. It is also always possible to insert a row with a specific **ROWID** (or **ROWID** alias) value.

### Conflict clause

Nearly every column constraint and table constraint can have an optional conflict resolution clause. This clause can be used to specify what action SQLite takes if a command attempts to violate that particular constraint. Constraint violations most commonly happen when attempting to insert or update invalid row values.

The default action is **ON CONFLICT ABORT**, which will attempt to back-out any changes made by the command that caused the constraint violation, but will otherwise attempt to leave any current transaction in place and valid. For more information on the other conflict resolution choices, see [UPDATE](#). Note that the conflict resolution clause in **UPDATE** and **INSERT** applies to the actions taken by the **UPDATE** and **INSERT** commands themselves. Any conflict resolution clause found in a **CREATE TABLE** statement is applied to any command operating on the table.

### See Also

[DROP TABLE](#), [INSERT](#), [UPDATE](#), [CREATE INDEX](#)

## CREATE TRIGGER

Create a new trigger action

## Syntax

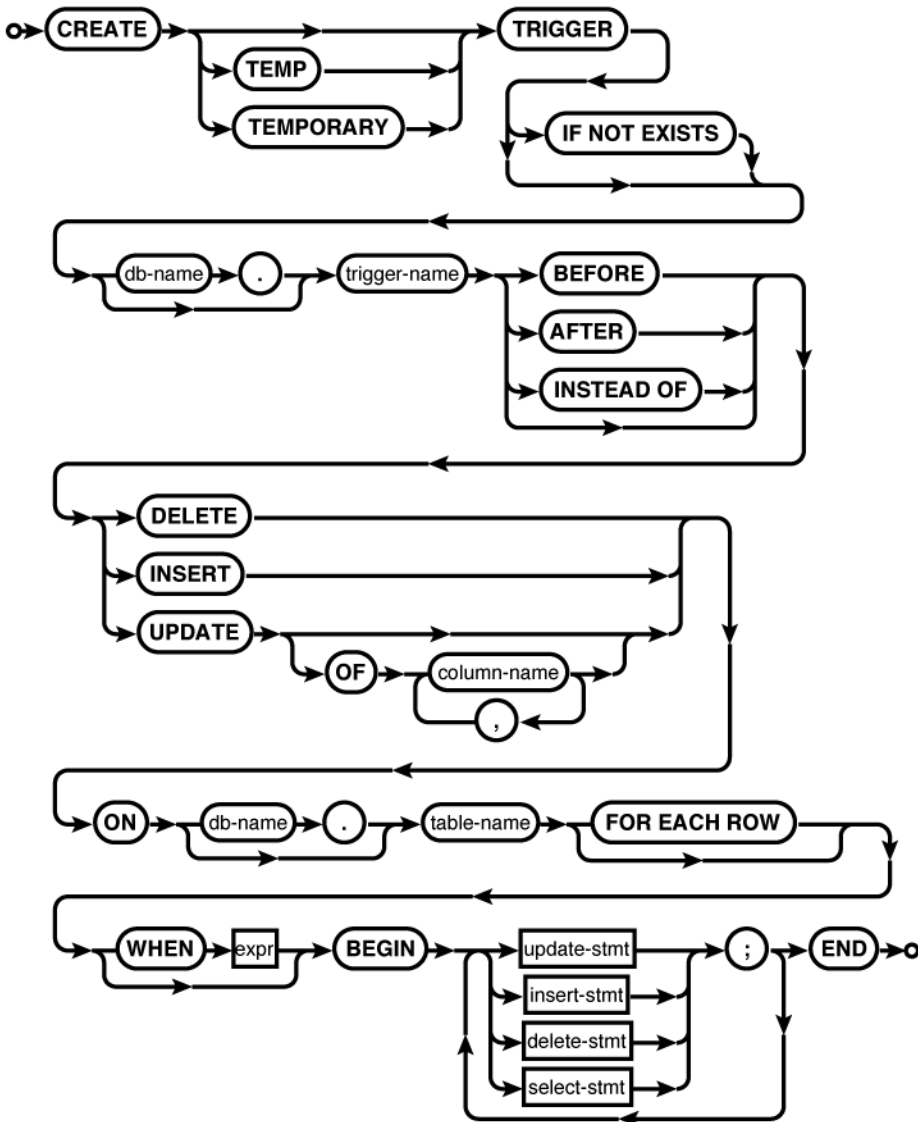

## Common Usage

```
CREATE TRIGGER database_name.trigger_name BEFORE INSERT ON table_name FOR EACH ROW
BEGIN stmt1; stmt2; END;
CREATE TRIGGER access_audit BEFORE UPDATE ON access FOR EACH ROW
BEGIN
    INSERT INTO audit_trail VALUES ( OLD.level, NEW.level, CURRENT_TIMESTAMP );
END;
```

## Description

The CREATE TRIGGER command creates a trigger and binds it to a table or view. When the conditions defined by the trigger are met, the trigger will “fire,” automatically executing statements found in the trigger body (the part between BEGIN and END). A table or view may have any number of triggers associated with it, including multiple triggers of the same type.

If the optional TEMP or TEMPORARY keyword is present, a trigger will be created in the temp database. A trigger can also be made temporary by qualifying the trigger name with the database name temp. If the trigger name is qualified with a database name, specifying TEMP or TEMPORARY will result in an error, even if the given database name is temp.

Temporary triggers can be attached to either temporary or standard (nontemporary) tables. A specific table instance can be chosen by qualifying the table name with a database name. In all other cases, the trigger and the table should be in the same database. Either the trigger name or the table name can be qualified with a database name (or both, if they match).

Triggers associated with tables may be BEFORE or AFTER triggers. If no time is specified, BEFORE is used. The timing indicates if the trigger fires before or after the defined trigger action. In both cases, the action is verified before the trigger is fired. For example, a BEFORE INSERT trigger will not fire if the insert will cause a constraint violation.

The trigger action can be either a DELETE, INSERT, or UPDATE statement that gets run against the trigger’s table. In the case of UPDATE, the trigger can fire when any column is updated, or only when one or more columns from the specified list is updated.

Triggers associated with views must be INSTEAD OF triggers. The default timing for views is still BEFORE, so the INSTEAD OF must be specified. As the name indicates, INSTEAD OF triggers fire in the place of the defined action. Although views are read-only in SQLite, defining one or more INSTEAD OF DELETE, INSERT, or UPDATE trigger will allow those commands to be run against the view. Very often, views will have a whole series of INSTEAD OF triggers to deal with different combinations of column updates.

The SQL standard defines both FOR EACH ROW as well as FOR EACH STATEMENT triggers. SQLite only supports FOR EACH ROW triggers, which fire once for each row affected by the specified condition. This makes the FOR EACH ROW clause optional in SQLite. Some popular databases that support both types of triggers will default to FOR EACH STATEMENT triggers, however, so explicit use of the FOR EACH ROW clause is recommended.

Triggers also have an optional WHEN clause that is used to control whether the trigger actually fires or not. Don’t underestimate the WHEN clause. In many cases, the logic in the WHEN clause is more complex than the trigger body.

## CREATE TRIGGER

The trigger body itself consists of one or more `INSERT`, `UPDATE`, `DELETE`, or `SELECT` statements. The first three commands can be used in the normal way. A `SELECT` statement can be used to call user-defined functions. Any results returned by a standalone `SELECT` statement will be ignored. Table identifiers within the trigger body cannot be qualified with a database name. All table identifiers must be from the same database as the trigger table.

Both the `WHEN` clause and the trigger body have access to some additional column qualifiers. Columns associated with the trigger table (or view) may be qualified with the pseudo-identifier `NEW` (in the case of `INSERT` and `UPDATE` triggers) or `OLD` (in the case of `UPDATE` and `DELETE` triggers). These represent the before and after values of the row in question and are only valid for the current row that caused the trigger to fire.

Commands found in a trigger body can also use the `RAISE` expression to raise an exception. This can be used to ignore, roll back, abort, or fail the current row in an error situation. For more information, see [RAISE](#) and [UPDATE](#).

There are some additional limits on trigger bodies. Within a trigger body, `UPDATE` and `DELETE` commands cannot use index overrides (`INDEXED BY`, `NOT INDEXED`), nor is the `ORDER BY...LIMIT` syntax supported (even if support has been properly enabled). The `INSERT...DEFAULT VALUES` syntax is also unsupported. If a trigger is fired as the result of a command with an explicit `ON CONFLICT` clause, the higher-level conflict resolution will override any `ON CONFLICT` clause found in a trigger body.

If a trigger modifies rows from the same table it is attached to, the use of `AFTER` triggers is strongly recommended. If a `BEFORE` trigger modifies the rows that are part of the original statement (the one that caused the trigger to fire) the results can be undefined. Also, the `NEW.ROWID` value is not available to `BEFORE INSERT` triggers unless an explicit value has been provided.

If a table is dropped, all of its triggers are automatically dropped. Similarly, if a table is renamed (via `ALTER TABLE`), any associated triggers will be updated. However, dropping or altering a table will not cause references found in a trigger body to be updated. If a table is dropped or renamed, make sure any triggers that reference it are updated as well. Failing to do so will cause an error when the trigger is fired.

Creating a trigger that already exists will normally generate an error. If the optional `IF NOT EXISTS` clause is provided, this error is silently ignored. This leaves the original definition (and data) in place.

One final note. Some of the syntax and many of the functional limitations of `CREATE TRIGGER` are checked at execution, not at creation. Just because the `CREATE TRIGGER` command returned without error doesn't mean the trigger description is valid. It is strongly suggested that all triggers are verified and tested. If a trigger encounters an error, that error will be bubbled up to the statement that caused the trigger to fire. This can cause perplexing results, such as commands producing errors about tables or columns that are not part of the original statement. If a command is producing an unexplained or odd error, check to make sure there are no faulty triggers associated with any of the tables referenced by the command.

### See Also

[DROP TRIGGER](#), [CREATE TABLE](#), [CREATE VIEW](#), [INSERT](#), [UPDATE](#), [DELETE](#), [RAISE](#) [SQL Expr, Ap D]

## CREATE VIEW

Create a new view

### Syntax

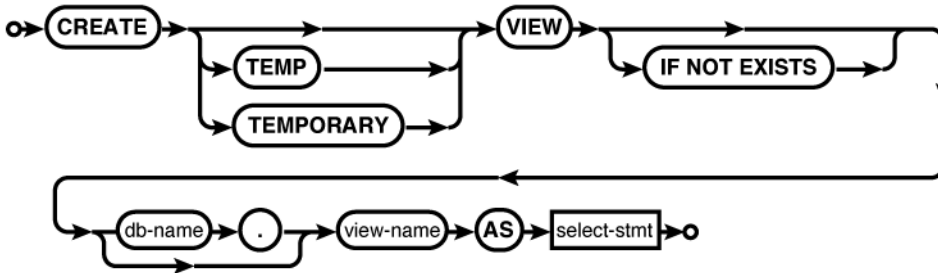

### Common Usage

```
CREATE VIEW database_name.view_name AS SELECT...;
```

### Description

The `CREATE VIEW` statement establishes a new view within the named database. A view acts as a prepackaged subquery statement, and can be accessed and referenced as if it were a table. A view does not actually instance the data, but is dynamically generated each time it is accessed.

If the optional `TEMP` or `TEMPORARY` keyword is present, the view will be created in the `temp` database. Specifying either `TEMP` or `TEMPORARY` in addition to an explicit database name will result in an error, unless the database name is `temp`.

Temporary views may access tables from other attached databases. All nontemporary views are limited to referencing data sources from within their own database.

Creating a view that already exists will normally generate an error. If the optional `IF NOT EXISTS` clause is provided, this error is silently ignored. This leaves the original definition in place.

### See Also

[DROP VIEW](#), [CREATE TABLE](#), [SELECT](#)

## CREATE VIRTUAL TABLE

Create a new virtual table

### Syntax

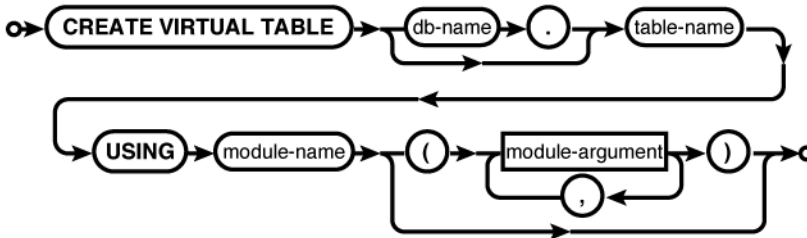

### Common Usage

```
CREATE VIRTUAL TABLE database_name.table_name USING weblog( access.log );
CREATE VIRTUAL TABLE database_name.table_name USING fts3( );
```

### Description

The `CREATE VIRTUAL TABLE` command creates a virtual table. Virtual tables are data sources that are defined by code and can represent highly optimized data sources or external data sources. The standard SQLite distribution includes virtual table implementations for Full Text Search, as well as an R\*Tree-based indexing system.

Virtual tables are covered in detail in [Chapter 10](#).

A virtual table is removed with the standard `DROP TABLE` command.

### See Also

[sqlite3\\_create\\_module\(\)](#) [C API, Ap G], [DROP TABLE](#)

## DELETE

Delete rows from a table

### Syntax



### Common Usage

```
DELETE FROM database_name.table_name;
DELETE FROM database_name.table_name WHERE id = 42;
```

### Description

The `DELETE` command permanently removes rows from a table. Any row that satisfies the `WHERE` expression will be removed. A `WHERE` condition that causes no rows to be deleted is not considered an error. If no `WHERE` condition is provided, it is assumed to always be true, and every row in the table will be deleted.



A DELETE command with no WHERE clause will delete *every* row in a table.

If no WHERE clause is provided, there are some situations when SQLite can simply truncate the whole table. This is much faster than deleting every row individually, but it skips any per-row processing. Truncation will only happen if the table has no triggers and is not part of a foreign key relationship (assuming foreign key support is enabled). Truncation can also be disabled by having an authorizer return `SQLITE_IGNORE` for the delete operation (see [sqlite3\\_set\\_authorizer\(\)](#)).

If the SQLite library has been compiled with the optional `SQLITE_ENABLE_UPDATE_DELETE_LIMIT` directive, an optional `ORDER BY...LIMIT` clause may be used to delete a specific number of rows. See the SQLite website for more details.

When a DELETE appears within a trigger body, additional limitations apply. See [CREATE TRIGGER](#).

Deleting data from a table will not decrease the size of the database file unless auto-vacuum mode is enabled. To recover space previously taken up by deleted data, the `VACUUM` command must be run.

### See Also

[INSERT](#), [UPDATE](#), [VACUUM](#), [auto\\_vacuum](#) [PRAGMA, Ap F], [CREATE TRIGGER](#)

---

## DETACH DATABASE

Detach a database file

### Syntax



### Common Usage

```
DETACH DATABASE database_name;
```

### Description

The `DETACH DATABASE` command detaches and dissociates a named database from a database connection. If the same file has been attached multiple times, this will only detach the named attachment. If the database is an in-memory or temporary database, the database will be destroyed and the contents will be lost.

You cannot detach the `main` or `temp` databases. The `DETACH` command will fail if issued inside a transaction.

### See Also

[ATTACH DATABASE](#)

## DROP INDEX

Delete a table index from a database

### Syntax

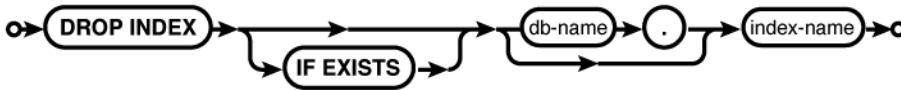

### Common Usage

```
DROP INDEX database_name.index_name;
```

### Description

The DROP INDEX command deletes an explicitly created index. The index and all the data it contains is deleted from the database. The table the index references is not modified. You cannot drop automatically generated indexes, such as those that enforce unique constraints declared in table definitions.

Dropping an index that does not exist normally generates an error. If the optional IF EXISTS clause is provided, this error is silently ignored.

### See Also

[CREATE INDEX](#), [CREATE TABLE](#), [DROP TABLE](#)

## DROP TABLE

Delete a table from a database

### Syntax

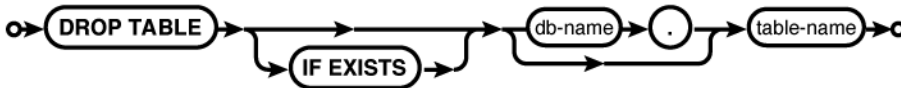

### Common Usage

```
DROP TABLE database_name.table_name;
```

### Description

The DROP TABLE command removes a table from a database. The table and all the data it contains are permanently removed from the database. Any associated indexes and triggers are also removed. Views that might reference the table are not removed. Delete triggers will not be fired.

The DROP TABLE command may also be used to remove virtual tables. In that case, a destroy request is sent to the table module, which is free to do as it sees fit.



If foreign keys are enabled, the `DROP TABLE` command will perform the equivalent of a `DELETE` for each row in the table. This happens after any associated triggers have been dropped, so this will not cause any delete triggers to fire. If any immediate key constraints are violated, the `DROP TABLE` command will fail. If any deferred constraints are violated, an error will be returned when the transaction is committed.

Unless the database is in auto-vacuum mode, dropping a table will not cause the database file to shrink in size. The database pages used to hold the table data will be placed on the free list, but they will not be released. The database must be vacuumed to release the free database pages.

Dropping a table that does not exist normally generates an error. If the optional `IF EXISTS` clause is provided, this error is silently ignored.

### See Also

[CREATE TABLE](#), [ALTER TABLE](#), [DROP INDEX](#), [DROP TRIGGER](#), [auto\\_vacuum](#) [PRAGMA, Ap F], [VACUUM](#)

## DROP TRIGGER

Delete a trigger action from a database

### Syntax

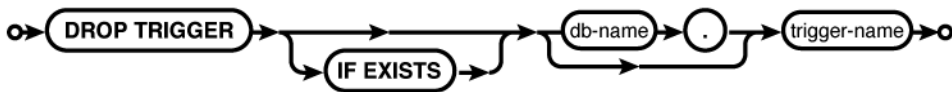

### Common Usage

```
DROP TRIGGER database_name.trigger_name;
```

### Description

The `DROP TRIGGER` command removes a trigger from the database. A trigger will also be removed when the associated table is removed.

Dropping a trigger that does not exist normally generates an error. If the optional `IF EXISTS` clause is provided, this error is silently ignored.

### See Also

[CREATE TRIGGER](#), [DROP TABLE](#)

## DROP VIEW

Delete a view from a database

### Syntax

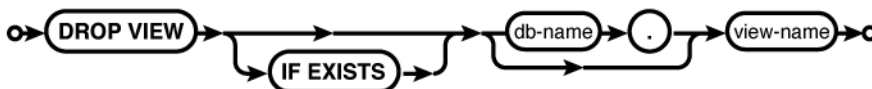

## Common Usage

```
DROP VIEW database_name.view_name;
```

## Description

The `DROP VIEW` command removes a view from the database. Although the view will no longer be available, none of the referenced data is altered in any way. Dropping a view will also remove any associated triggers.

Dropping a view that does not exist will normally generate an error. If the optional `IF EXISTS` clause is provided, this error is silently ignored.

## See Also

[CREATE VIEW](#), [CREATE TABLE](#), [DROP TRIGGER](#)

## END TRANSACTION

Finish and commit a transaction

See: [COMMIT TRANSACTION](#)

## EXPLAIN

Explain the query plan

### Syntax



## Common Usage

```
EXPLAIN INSERT ...;
EXPLAIN QUERY PLAN SELECT ...;
```

## Description

The `EXPLAIN` command offers insight into the internal database operation. Placing `EXPLAIN` in front of any SQL statement (other than itself) returns information about how SQLite would execute the given SQL statement. The SQL statement is not actually executed.

By itself, `EXPLAIN` will return a result set that describes the internal VDBE instruction sequence used to execute the provided SQL statement. A fair amount of knowledge is required to understand the output.

The full `EXPLAIN QUERY PLAN` variant will return a high-level summary of the query plan using English-like explanations of how the query will be assembled and if data will be accessed by a table scan or by index lookup. The `EXPLAIN QUERY PLAN` command is most useful for tuning `SELECT` statements and adjusting index placement.

These commands exist to help database administrators and developers understand how SQLite is processing SQL commands. They are designed for interactive tuning and adjustments. It is

not recommended that applications programmatically query or utilize this data, as both the data and the format may change from one version of SQLite to the next.

## INSERT

Insert new rows into a table

### Syntax

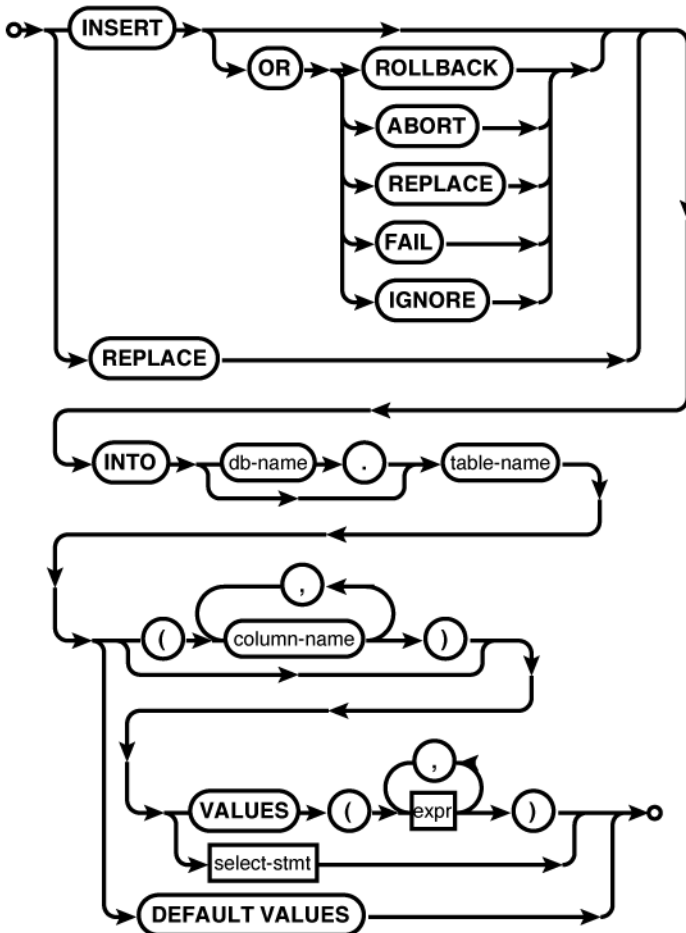

### Common Usage

```

INSERT INTO database_name.table_name ( col1, col2 ) VALUES ( val1, val2 );
INSERT INTO table_name VALUES ( val1, val2, val3... );
INSERT INTO table_name ( col1, col2 ) SELECT c1, c2 FROM...;
INSERT INTO table_name DEFAULT VALUES;
INSERT OR IGNORE INTO table_name ( col1, col2 ) VALUES ( val1, val2 );
REPLACE INTO table_name ( col1, col2 ) VALUES ( val1, val2 );
  
```

## Description

The `INSERT` command adds new rows to tables. An individual `INSERT` command can only insert rows into one table, and in most cases can only insert one row at a time. There are several variants of the `INSERT` command. The primary differences relate to how the columns and values are specified.

The basic format of the `INSERT` command starts with the command word `INSERT`, followed by an optional conflict resolution clause (`OR ROLLBACK`, etc.). The `INSERT` conflict resolution clause is identical to the one found in the `UPDATE` command. See [UPDATE](#) for more information on the different conflict resolution options and how they behave. The command word `REPLACE` can also be used, which is just a shortcut for `INSERT OR REPLACE`. This is discussed in more detail below.

After the conflict clause, the command declares which table it is acting upon. This is generally followed by a list of columns in parentheses. This column list defines which columns will have values set in the newly inserted row. If no column list is given, a default column list is assumed to include all of the table's columns, in order, as they appear in the table definition. A default list will not include the raw `ROWID` column, but any `ROWID` alias (`INTEGER PRIMARY KEY`) column is included. If an explicit list of columns is given, the list may contain any column (including the `ROWID` column) in any order.

Following the column list is a description of the values to insert into the new row. The values are most commonly defined by the keyword `VALUES`, followed by an explicit list of values in parentheses. The values are matched to columns by position. No matter how the column list is defined, the column list and the value list must have the same number of entries so that one value can be matched to each column in the column list.

The `INSERT` values can also be defined with a subquery. Using a subquery is the only case when a single `INSERT` command can insert more than one row. The result set generated by the subquery must have the same number of columns as the column list. As with the value list, the values of the subquery result set are matched to the insert columns by position.

Any table column that does not appear in the insert column list is assigned a default value. Unless the table definition says otherwise, the default value is a `NULL`. If you have a `ROWID` alias column that you want assigned an automatic value, you must use an explicit column list, and that list must not include the `ROWID` alias. If a column is contained in the column list, either explicitly, or by default, a value must be provided for that column. There is no way to specify a default value except by leaving the column out of the column list, or knowing what the default value is and explicitly inserting it.

Alternatively, the column list and value list can be skipped all together. The `DEFAULT VALUES` variant provides neither a column list nor a source of values and can be used to insert a new row that consists entirely of default values.

Because a typical `INSERT` command only allows a single row to be inserted, it is not uncommon to have a string of `INSERT` commands that are used to bulk-load or otherwise populate a new table. Like any other command, each `INSERT` is normally wrapped in its own transaction. Committing and synchronizing this transaction can be quite expensive, often limiting the number of inserts to a few dozen a second.

Due to the expense associated with committing a transaction, it is very common to batch multiple inserts into a single transaction. Especially in the case of bulk inserts, it is not uncommon to batch 1,000 or even 10,000 or more `INSERT` commands into a single transaction, allowing a much higher insert rate. Just understand that if an error is encountered, there are situations where the whole transaction will be rolled back. While this may be acceptable for loading bulk data from a file (that can simply be rerun), it may not be acceptable for data that is inserted from a real-time data stream. Batch transactions greatly speed things up, but they can also make it significantly more difficult to recover from an error.

One final word on the `INSERT OR REPLACE` command. This type of command is frequently used in event-tracking systems where a “last seen” timestamp is required. When an event is processed, the system needs to either insert a new row (if this type of event has never been seen before) or it needs to update an existing record. While the `INSERT OR REPLACE` variant seems perfect for this, it has some specific limitations. Most importantly, the command truly is an “insert or replace” and not an “insert or update.” The `REPLACE` option fully deletes any old rows before processing the `INSERT` request, making it ineffective to update a subset of columns. In order to effectively use the `INSERT OR REPLACE` option, the `INSERT` needs to be capable of completely replacing the existing row, and not simply updating a subset of columns.

### See Also

[UPDATE](#), [BEGIN TRANSACTION](#)

---

## PRAGMA

Look up or modify an SQLite configuration

### Syntax

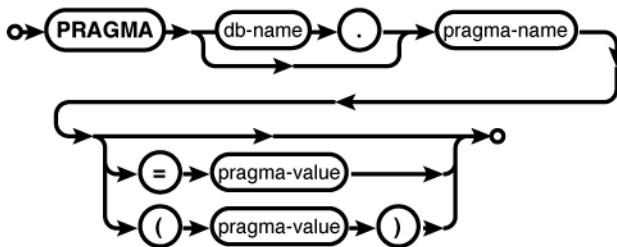

### Common Usage

```

PRAGMA page_size;
PRAGMA cache_size = 5000;
PRAGMA table_info( table_name );

```

### Description

The `PRAGMA` command tunes and configures SQLite’s internal components. It is a bit of a catchall command, used to configure or query configuration parameters for both the database engine and database files. It can also be used to query information about a database, such as a list of tables, indexes, column information, and other aspects of the schema.

The PRAGMA command is the only command, outside of SELECT, that may return multiple rows. [Appendix F](#) covers the different PRAGMA commands in detail.

### See Also

[Appendix F](#)

---

## REINDEX

Rebuild an index from source data

### Syntax

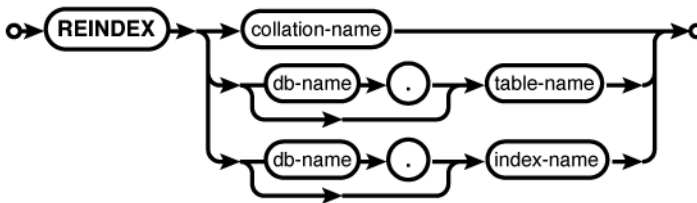

### Common Usage

```

REINDEX collation_name;
REINDEX database_name.table_name;
REINDEX database_name.index_name;
  
```

### Description

The REINDEX command deletes the data within an index and rebuilds the index structure from the source table data. The table referenced by the index is not changed.

REINDEX is most frequently used when the definition of a collation sequence has changed and all of the indexes that use that collation must be rebuilt. This ensures that the index order correctly matches the order defined by the collation.

If a collation name is provided, all indexes that use that collation, in all attached databases, will be reindexed. If a table name is given, all the indexes associated with that table will be reindexed. If a specific index name is given, just that index will be rebuilt.

### See Also

[CREATE INDEX](#), [DROP INDEX](#)

---

## RELEASE SAVEPOINT

Remove and release save-point from transaction log

### Syntax

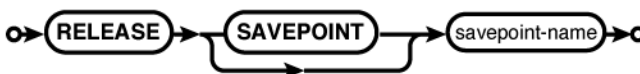

## Common Usage

```
RELEASE savepoint_name;
```

## Description

The `RELEASE SAVEPOINT` command removes a save-point from the transaction log. It indicates that any modifications made since the named save-point was set have been accepted by the application logic.

Normally, a `RELEASE` will not alter the database or transaction log, other than removing the save-point marker. Releasing a save-point will not commit any modifications to disk, nor will it make those changes available to other database connections accessing the same database. Changes bounded by a released save-point may still be lost if the transaction is rolled back to a prior save-point, or if the whole transaction is rolled back.

The one exception to this rule is if the named save-point was set outside of a transaction, causing an implicit transaction to be started. In that case, releasing the save-point will cause the whole transaction to be committed.

## See Also

[SAVEPOINT](#), [ROLLBACK TRANSACTION](#), [COMMIT TRANSACTION](#), [BEGIN TRANSACTION](#)

## REPLACE

Delete and reinsert an existing row

## Description

The `REPLACE` command is an alias for the `INSERT OR REPLACE` variant of the `INSERT` command.

See: [INSERT](#)

## ROLLBACK TRANSACTION

Undo part or all of the current transaction

## Syntax

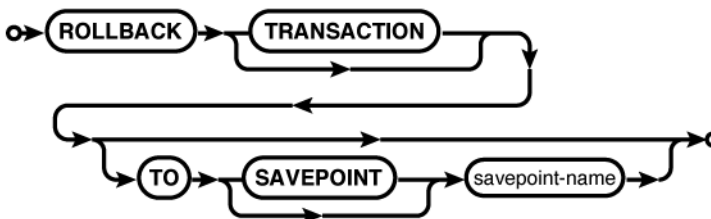

## Common Usage

```
ROLLBACK;
ROLLBACK TO SAVEPOINT savepoint_name;
```

## Description

The `ROLLBACK` command is used to roll back a transaction state. This is analogous to an undo function for transactions.

There are two forms of `ROLLBACK`. The most basic form has no `TO` clause and causes the entire transaction to be rolled back. Any and all changes and modifications made to the database as part of the transaction are reverted, the transaction is released, and the database connection is put back into autocommit mode with no active transaction.

If a `TO` clause is provided, the transaction is rolled back to the state it was in just *after* the named save-point was created. The named save-point will remain on the save-point stack. You can roll back to any save-point, but if more than one save-point exists with the same name, the most recent save-point will be used. After rolling back to a save-point, the original transaction is still active.

If the named save-point was created outside of a transaction (causing an implicit transaction to be started) the whole transaction will be rolled back, but the save-point and transaction will remain in place.

## See Also

[BEGIN TRANSACTION](#), [COMMIT TRANSACTION](#), [SAVEPOINT](#), [RELEASE SAVEPOINT](#)

---

## SAVEPOINT

Place a save-point marker in the transaction command sequence

### Syntax

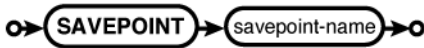

### Common Usage

```
SAVEPOINT savepoint_name;
```

### Description

The `SAVEPOINT` command creates a save-point marker in the transaction log. If there is no active transaction in progress, the save-point will be marked and an implicit `BEGIN DEFERRED TRANSACTION` will be issued.

Save-points allow subsections of a transaction to be rewound and partially rolled back without losing the entire transaction state. A transaction can have multiple active save-points. Conceptually, these save-points act as if they were on a stack. Save-point names do not need to be unique.

Save-points are useful in multistep processes where each step needs to be attempted and verified before proceeding to the next step. By creating save-points before starting each step, it may be possible to revert just a single step, rather than the whole transaction, when a logical error case is encountered.



## See Also

[RELEASE SAVEPOINT](#), [ROLLBACK TRANSACTION](#), [BEGIN TRANSACTION](#)

## SELECT

Query data from the database

## Syntax

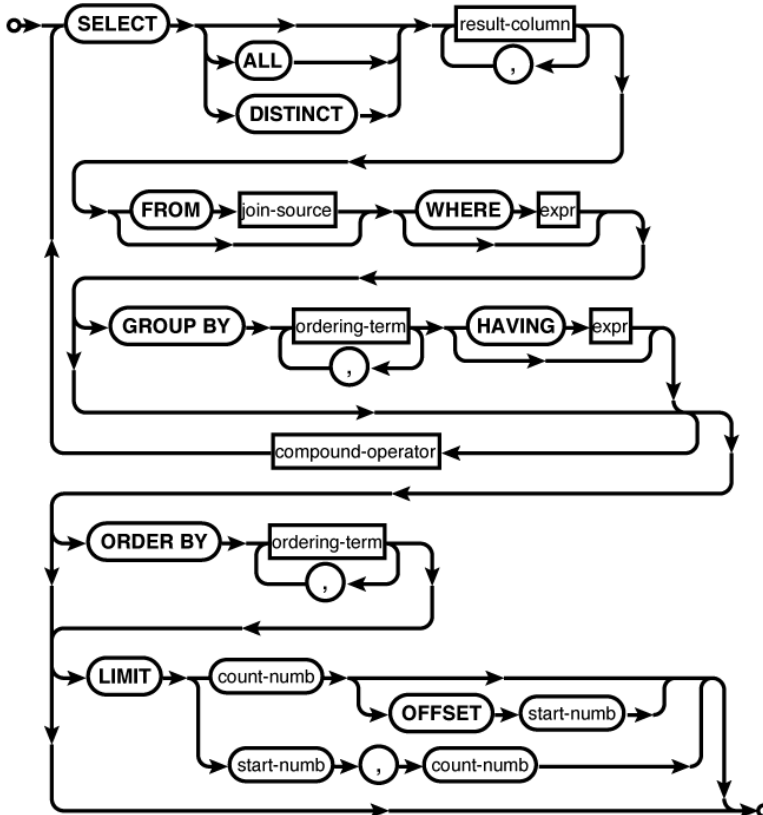

## result-column:

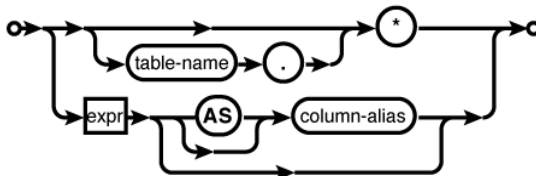

SELECT

join-source:

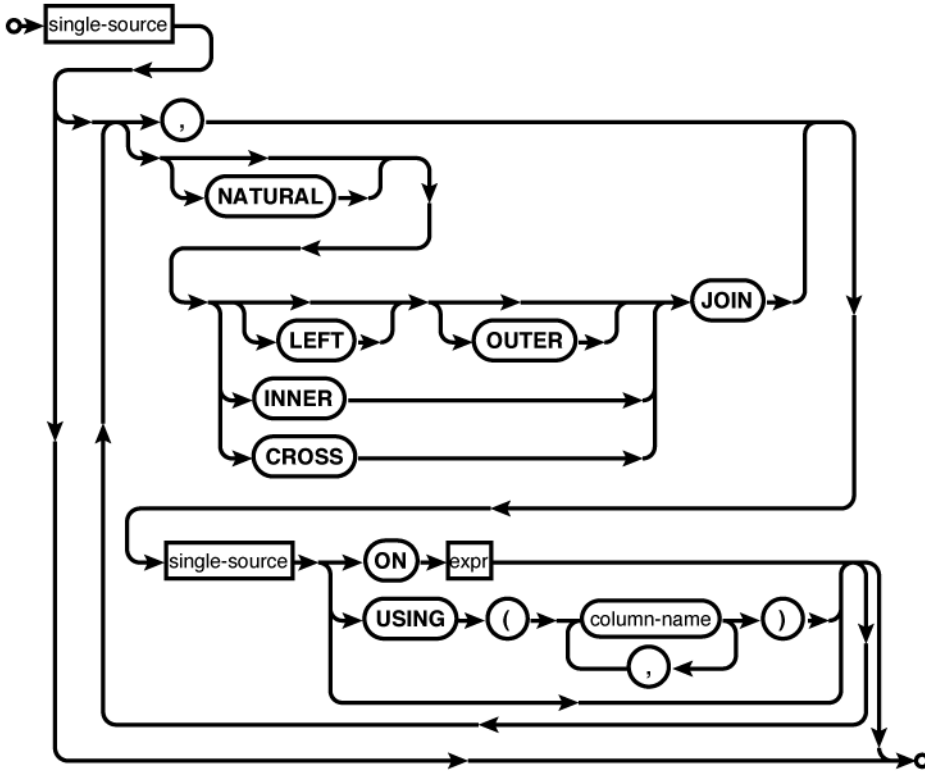

single-source:

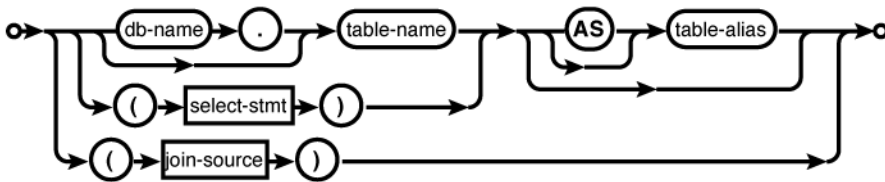

ordering-term:

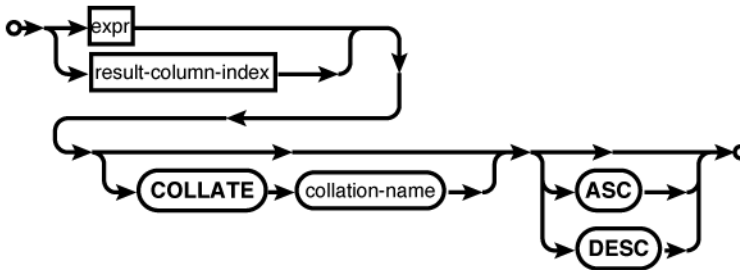

compound-operator:

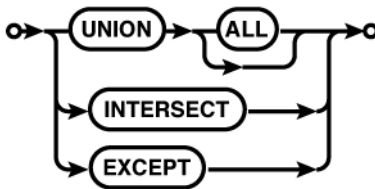

## Common Usage

```

SELECT * FROM tbl;
SELECT name FROM employees WHERE employee_id = 54923;
SELECT 5 + 6;

```

## Description

The `SELECT` command is used to query the database and return a result. The `SELECT` command is the only SQL command capable of returning a user-generated result, be it a table query or a simple expression. Most consider `SELECT` to be the most complex SQL command. Although the basic format is fairly easy to understand, it does take some experience to understand its full power.

All of [Chapter 5](#) is devoted to the `SELECT` command.

## Basic format

The core `SELECT` command follows a simple pattern that can be roughly described as `SELECT output FROM input WHERE filter`. The output section describes the data that makes up the result set, the input section describes what tables, views, subqueries, etc., will act as data sources, and the filter section sets up conditions on which rows are part of the result set and which rows are filtered out.

A `SELECT` can either be `SELECT ALL` (default) or `SELECT DISTINCT`. The `ALL` keyword returns all rows in the result set, regardless of their composition. The `DISTINCT` keyword will force the select statement to eliminate duplicate results in the result set. There is usually a considerable performance penalty for calculating larger `DISTINCT` results.

## SELECT

The result set columns are defined by a series of comma-separated expressions. Every `SELECT` statement must have at least one result expression. These expressions often consist of only a source column name, although they can be any general expression. The character `*` means “return all columns,” and will include all standard table columns from all of the source tables. All the standard columns of a specific source table can be returned with the format `table_name.*`. In both cases, the `ROWID` column will not be included, although `ROWID` alias columns will be included. Virtual tables can also mark some columns as hidden. Like the `ROWID` column, hidden columns will not be returned by default, but can be explicitly named as a result column.

Result columns can be given explicit names with an optional `AS` clause (the actual `AS` keyword is optional as well). Unless an `AS` clause is given, the name of the output column is at the discretion of the database engine. If an application depends on matching the names of specific output columns, the columns should be given explicit names with an `AS` clause.

The `FROM` clause defines where the data comes from and how it is shuffled together. If no `FROM` clause is given, the `SELECT` statement will return only one row. Each source is joined together with a comma or a `JOIN` operation. The comma acts as an unconditional `CROSS JOIN`. Different sources, including tables, subqueries, or other `JOIN` statements, can be grouped together into a large transitory table, which is fed through the rest of the `SELECT` statement, and ultimately used to produce the result set. For more information on the specific `JOIN` operators, see “[FROM Clause](#)” on page 63.

Each data source, be it a named table or a subquery, can be given an optional `AS` clause. Similar to result set columns, the actual `AS` keyword is optional. The `AS` clause allows an alias to be assigned to a given source. This is important to disambiguate table instances (for example, in a self-join).

The `WHERE` clause is used to filter rows. Conceptually, the `FROM` clause, complete with joins, is used to define a large table that consists of every possible row combination. The `WHERE` clause is evaluated against each of those rows, passing only those rows that evaluate to true. The `WHERE` clause can also be used to define join conditions, by effectively having the `FROM` clause produce the Cartesian product of the two tables, and use the `WHERE` clause to filter out only those rows that meet the join condition.

### Additional clauses

Beyond `SELECT`, `FROM`, and `WHERE`, the `SELECT` statement can do additional processing with `GROUP BY`, `HAVING`, `ORDER BY`, and `LIMIT`.

The `GROUP BY` clause allows sets of rows in the result set to be collapsed into single rows. Groups of rows that share equivalent values in all of the expressions listed in the `GROUP BY` clause will be condensed to a single row. Normally, every source column reference in the result set expressions should be a column or expression included in the `GROUP BY` clause, or the column should appear as a parameter of an aggregate function. The value of any other source column is the value of the last row in the group to be processed, effectively making the result undefined. If a `GROUP BY` expression is a literal integer, it is assumed to be a column index to the result set. For example, the clause `GROUP BY 2` would group the result set using the values in the second result column.

A **HAVING** clause can only be used in conjunction with a **GROUP BY** clause. Like the **WHERE** clause, a **HAVING** expression is used as a row filter. The key difference is that the **HAVING** expression is applied after any **GROUP BY** manipulation. This sequence allows the **HAVING** expression to filter aggregate outputs. Be aware that the **WHERE** clause is usually more efficient, since it can eliminate rows earlier in the **SELECT** pipeline. If possible, filtering should be done in the **WHERE** clause, saving the **HAVING** clause to filter aggregate results.

The **ORDER BY** clause sorts the result set into a specific order. Typically, the output ordering is not defined. Rows are returned as they become available, and no attempt is made to return the results in any specific order. The **ORDER BY** clause can be used to enforce a specific output ordering. Output is sorted by each expression in the clause, in turn, from most specific to least specific. The fact that the output of a **SELECT** can be ordered is one of the key differences between an SQL table and a result set. As with **GROUP BY**, if one of the **ORDER BY** expressions is a literal integer, it is assumed to be a column index to the result set.

Finally, the **LIMIT** clause can be used to control how many rows are returned, starting at a specific offset. If no offset is provided, the **LIMIT** will start from the beginning of the result set. Note that the two syntax variations (comma or **OFFSET**) provide the parameters in the opposite order.

Since the row order of a result is undefined, a **LIMIT** is most frequently used in conjunction with an **ORDER BY** clause. Although it is not strictly required, including an **ORDER BY** brings some meaning to the limit and offset values. There are very few cases when it makes sense to use a **LIMIT** without some type of imposed ordering.

### Compound statements

Compound statements allow one or more **SELECT...FROM...WHERE...GROUP BY...HAVING** sub-statements to be brought together using set operations. SQLite supports the **UNION**, **UNION ALL**, **INTERSECT**, and **EXCEPT** compound operators. Each **SELECT** statement in a compound **SELECT** must return the same number of columns. The names of the result set columns will be taken from the first **SELECT** statement.

The **UNION** operator returns the union of the **SELECT** statements. By default, the **UNION** operator is a proper set operator and will only return distinct rows (including those from a single table). **UNION ALL**, by contrast, will return the full set of rows returned by each **SELECT**. The **UNION ALL** operator is significantly less expensive than the **UNION** operator, so the use of **UNION ALL** is encouraged, when possible.

The **INTERSECT** command will return the set of rows that appear in both **SELECT** statements. Like **UNION**, the **INTERSECT** operator is a proper set operation and will only return one instance of each unique row, no matter how many times that row appears in both result sets of the individual **SELECT** statements.

The **EXCEPT** compound operator acts as a set-wise subtraction operator. All unique rows in the first **SELECT** that do not appear in the second **SELECT** will be returned.

### See Also

[CREATE TABLE](#), [INSERT](#), [UPDATE](#), [DELETE](#)

## UPDATE

Modify existing rows in a table

### Syntax

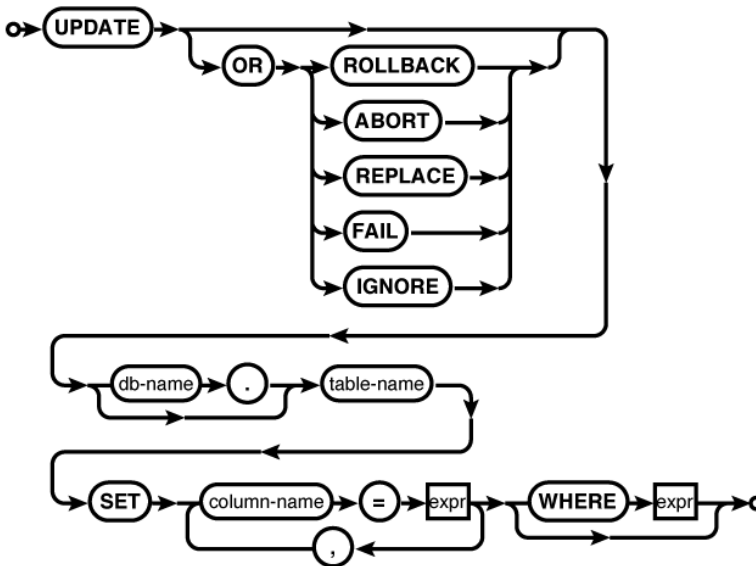

### Common Usage

```
UPDATE database_name.table_name SET col1 = val1, col2 = val2 WHERE id = 42;
```

### Description

The **UPDATE** command modifies one or more column values within existing table rows. The command starts out with a conflict resolution clause, followed by the name of the table that contains the rows we're updating. The table name is followed by a list of column names and new values. The final **WHERE** clause determines which rows are updated. A **WHERE** condition that causes no rows to be updated is not considered an error. If no **WHERE** clause is given, every row in the table is updated.

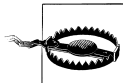

An **UPDATE** command with no **WHERE** clause will update *every* row in a table.

The values that are used to update a row may be given as expressions. These expressions are evaluated within the context of the original row values. This allows the value expression to refer to the old row value. For example, to increment a column value by one, you might find SQL similar to `UPDATE...SET col = col + 1 WHERE...`. Columns and values can be given in any order, as long as they appear in pairs. Any column, including **ROWID**, may be updated. Any columns that do not appear in the **UPDATE** command remain unmodified. There is no way to return a column to its default value.

If the SQLite library has been compiled with the optional `SQLITE_ENABLE_UPDATE_DELETE_LIMIT` directive, an optional `ORDER BY...LIMIT` clause may be used to update a specific number of rows. See the SQLite website ([http://www.sqlite.org/lang\\_update.html](http://www.sqlite.org/lang_update.html)) for more details.

The optional conflict resolution clause found at the beginning of the `UPDATE` (or `INSERT`) command is a nonstandard extension that controls how SQLite reacts to a constraint violation. For example, if a column must be unique, any attempt to update the value of that column to a value that is already in use by another row would cause a constraint violation. The constraint resolution clause determines how this situation is resolved.

#### ROLLBACK

A `ROLLBACK` is immediately issued, rolling back any current transaction. An `SQLITE_CONSTRAINT` error is returned to the calling process. If no explicit transaction is currently in progress, the behavior will be identical to an `ABORT`.

#### ABORT

This is the default behavior. Changes caused by the current command are undone and `SQLITE_CONSTRAINT` is returned, but no `ROLLBACK` is issued. For example, if a constraint violation is encountered on the fourth of ten possible row updates, the first three rows will be reverted, but the current transaction will remain active.

#### FAIL

The command will fail and return `SQLITE_CONSTRAINT`, but any rows that have been previously modified will not be reverted. For example, if a constraint violation is encountered on the fourth of ten possible row updates, the first three modifications will be left in place and further processing will be cut short. The current transaction will not be committed or rolled back.

#### IGNORE

Any constraint violation error is ignored. The row update will not be processed, but no error is returned. For example, if a constraint violation is encountered on the fourth of ten possible rows, not only are the first three row modifications left in place, processing continues with the remaining rows.

#### REPLACE

The specific action taken by a `REPLACE` resolution depends on what type of constraint is violated.

If a `UNIQUE` constraint is violated, the existing rows that are causing the constraint violation will first be deleted, and then the `UPDATE` (or `INSERT`) is allowed to be processed. No error is returned. This allows the command to succeed, but may result in one or more rows being deleted. In this case, any delete triggers associated with this table will not fire unless recursive triggers are enabled. Currently, the update hook is not called for automatically deleted rows, nor is the change counter incremented. These two behaviors may change in a future version, however.

If a `NOT NULL` constraint is violated, the `NULL` is replaced by the default value for that column. If no default value has been defined, the `ABORT` resolution is used.

If a `CHECK` constraint is violated, the `IGNORE` resolution is used.

## VACUUM

Any conflict resolution clause found in an UPDATE (or INSERT) command will override any conflict resolution clause found in a table definition.

### See Also

[INSERT](#), [DELETE](#), [CREATE TABLE](#)

---

## VACUUM

Recover free space and optimize database

### Syntax

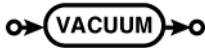

### Common Usage

```
VACUUM;
```

### Description

The VACUUM command recovers free space from the database file and releases it to the filesystem. VACUUM can also defragment database structures and repack individual database pages. VACUUM can only be run against the main database (the database used to create the database connection). VACUUM has no effect on in-memory databases.

When data objects (rows, whole tables, indexes, etc.) are deleted or dropped from a database, the file size remains unchanged. Any database pages that are recovered from deleted objects are simply marked as free and available for any future database storage needs. As a result, under normal operations the database file can only grow in size.

Additionally, as rows are inserted and deleted from the database, the tables and indexes can become fragmented. In a dynamic database that normally experiences a high number of inserts, updates, and deletes, it is common for free pages to be scattered all across the database file. If a table or index requires additional pages for more storage, these will first be allocated off the free list. This means the actual parts of the database file that hold a particular table or index may become scattered and mixed all across the database file, lowering seek performance.

Finally, as rows are inserted, updated, and deleted, unused data blocks and other “holes” may appear within the individual database pages. This reduces the number of records that can be stored in a single page, increasing the total number of pages required to hold a table. In effect, this increases the storage overhead for the table, increasing read/write times and decreasing cache performance.

The vacuum process addresses all three of these issues by copying all the data within a database file to a separate, temporary database. This data transfer is done at a fairly high level, dealing with the logical elements of the database. As a result, individual database pages are “repacked,” data objects are defragmented, and free pages are ignored. This optimizes storage space, reduces seek times, and recovers any free space from the database file. Once all this is done, the content of the temporary database file is copied back to the original file.



As the `VACUUM` command rebuilds the database file from scratch, `VACUUM` can also be used to modify many database-specific configuration parameters. For example, you can adjust the page size, file format, default encoding, and a number of other parameters that normally become fixed once a database file is created. To change something, just set the default new database pragma values to whatever you wish, and vacuum the database.

Be warned that this behavior is not always desirable. For example, if you have a database with a nondefault page size or file format, you need to be sure that you explicitly set all the correct pragma values before you vacuum the database. If you fail to do this, the database will be re-created with the default configuration values, rather than the original values. If you work with database files that have any nonstandard parameters, it is best to explicitly set all of these configuration values before you vacuum the database.

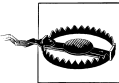

`VACUUM` will re-create the database using the current default values. For example, if you have a database that uses a custom page size and you wish to maintain that page size, you must issue the appropriate `PRAGMA page_size` command before issuing the `VACUUM` command. Failing to do so will result in the database being rebuilt with the default page size.

Logically, the database contents should remain unchanged from a `VACUUM`. The one exception is `ROWID` values. Columns marked `INTEGER PRIMARY KEY` will be preserved, but unaliased `ROWID` values may be reset. Also, indexes are rebuilt from scratch, rather than copied, so `VACUUM` does the equivalent of a `REINDEX` for each index in the database.

Generally, any reasonably dynamic database should be vacuumed periodically. A good rule of thumb is to consider a full `VACUUM` any time 30% to 40% of the database content changes. It may also be helpful to `VACUUM` the database after a large table or index is dropped.

Be warned that the `VACUUM` process requires exclusive access to the database file and can take a significant amount of time to complete. `VACUUM` also requires enough disk space to hold the original file, plus the optimized copy of the database, plus a rollback journal that can be as large as the original file.

SQLite also supports an auto-vacuum mode, which enables portions of the vacuum process to be done automatically. It has some significant limitations, however, and even if auto-vacuum is enabled, it is still advisable to do a full manual `VACUUM` from time to time.

### See Also

[auto\\_vacuum](#) [PRAGMA, Ap F], [temp\\_store](#) [PRAGMA, Ap F], [temp\\_store\\_directory](#) [PRAGMA, Ap F], [REINDEX](#)



---

# SQLite SQL Expression Reference

Like most computer languages, SQL has a fairly flexible expression syntax that can be used to combine and compute values. Nearly any time that an SQL command requires a result, conditional, or other value, a full expression can be used to express that value.

In addition to literal values, basic arithmetic operations, and function calls, expressions also contain column references, and complex operator expressions. These can be combined and mixed to create some fairly complex expressions and behaviors.

Many times an expression is used to define a conditional, such as which rows are returned in a result. In these contexts, an expression need only return a logical true or false value. In other situations, such as defining the result set of a `SELECT` statement, expressions that return diverse values are more appropriate.

The following sections each cover a specific category of expression. Although the different types of operators and expression formats have been divided up to make their descriptions easier to organize, remember that any expression type can be used in any other expression type.

If you want to play around with an operator or expression construction outside of a larger query, remember that you can execute any arbitrary expression by simply placing it in a `SELECT` statement:

```
SELECT 1 + 1;
```

This is extremely useful for testing specific conditions, value conversions, and other situations that may be causing problems within some larger SQL statement.

# Literal Expressions

The simplest type of expression is a literal, or inline value. These are specific values that are expressed directly in the SQL command. SQLite supports a number of literal forms, including one for each major datatype.

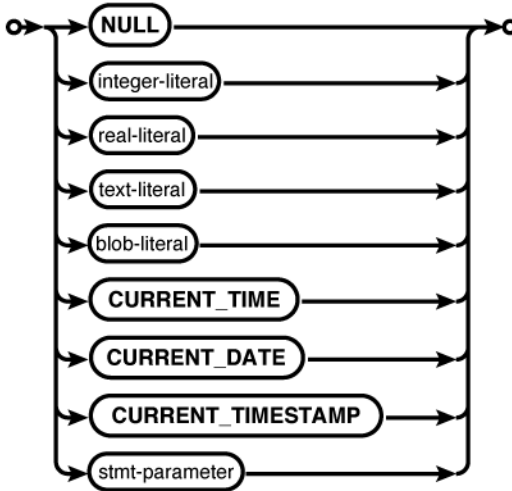

Each supported datatype has a specific literal representation. This allows the expression processor to understand the desired datatype as well as the specific value.

## *NULL*

A NULL is represented by the bare keyword NULL.

NULL

## *Integer*

An integer number is represented by a bare sequence of numeric digits. All integers must be given in base-10. A prefix of zero digits does not represent octal numbers, nor are hexadecimal integers supported. No magnitude separators (such as a comma after the thousands digit) are allowed. The number can be prefaced with a + or - to represent the sign of the number:

```
8632 -- Eight thousand, six hundred, thirty-two
0032 -- Thirty-two
-5   -- Negative five
+17  -- Seventeen
```

### *Real or floating-point*

A real number is represented by a bare sequence of numeric digits, followed by a period (decimal point), followed by another sequence of numeric digits. Either of the number sequences on the left or right of the decimal point can be omitted, but not both. SQLite always uses a period for the decimal point, regardless of internationalization settings. The number can be prefaced with a + or - to represent the sign of the number.

The initial set of numbers can be followed by an optional exponent, used to represent scientific notation. This is represented with the letter E (upper- or lowercase) followed by an optional + or -, followed by a sequence of numeric digits. The number does not need to be normalized.

If an exponent is included and the number group to the right of the decimal point is omitted, the decimal point may also be omitted. This is the only situation when the decimal point may be omitted:

32.4	--	32.4
-535.	--	-535.0
.43	--	0.43
4.5e+1	--	45.0
78.34E-5	--	0.0007834
7e2	--	700.0

### *Text or string*

A text value is represented by a string of characters enclosed in single quotes ( ' ' ). Double quotes ( " " ) are used to enclose identifiers, and should not be used to enclose literal values. To escape a single quote inside of a text literal, use two single quote characters in a row. The backslash character ( \ ), used in C and many other languages as an escape character, is not considered special by SQL and cannot be used to escape quote characters within text literals. A zero-length text value is not the same as a NULL:

'Jim has a dog.'	Jim has a dog.
'Jim''s dog is big.'	Jim's dog is big.
'C:\data\'	C:\data\
''	(zero-length text value)

### *BLOB*

A BLOB value is represented as an X (upper- or lowercase) followed by a text literal consisting of hexadecimal characters (0–9, A–F, a–f). Two hex characters are required for each full byte, so there must be an even number of characters. The length of the BLOB (in bytes) will be the number of hex characters divided by two. Like text values, the byte values are given in order:

```
X'7c'  
X'8A26E855'  
x''
```

Be aware that these are *input* formats that are recognized by the SQL command parser. They are not necessarily the *output* format used to display the values. The display format is up to the SQL environment, such as the `sqlite3` utility. To output values as valid SQL literals, see the `quote()` SQL function.

In addition to explicit literals, SQLite supports three named literals that can be used to insert the current date or time. When an expression is evaluated, these named tags will be converted into literal text expressions of the appropriate value. Supported tags are:

*CURRENT\_TIME*

A text value in the format *HH:MM:SS*.

*CURRENT\_DATE*

A text value in the format *YYYY-MM-DD*.

*CURRENT\_TIMESTAMP*

A text value in the format *YYYY-MM-DD HH:MM:SS*.

All times and dates are in UTC, not your local time zone.

Lastly, in any place that SQLite will accept a literal expression, it will also accept a statement parameter. Statement parameters are placeholders, similar to external variables. When using the C API, a statement can be prepared, values can then be bound to the parameters, and the statement can be executed. The statement can be reset, new values can be bound, and the statement can be executed again. Statement parameters allow frequently reused statements (such as many `INSERT` statements) to be prepared once and used over and over again by simply binding new values to the statement parameters. There are a number of performance and security benefits from this process, but it is only applicable for those using a programming interface to SQLite.

SQLite supports the following syntax for statement parameters:

*?*

A single question mark character. SQLite will automatically assign an index to each parameter.

*?numb*

A single question mark character followed by a number. The number will become the parameter index. The same index may be used more than once.

*:name*

A single colon character followed by a name. The API provides a way to look up the index based off the name. The same name may be used more than once.

*@name*

A single at (@) character followed by a name. The API provides a way to look up the index based off the name. The same name may be used more than once. This variation is nonstandard.

*\$name*

A single dollar sign character followed by a name. The API provides a way to look up the index based off the name. The same name may be used more than once. This variation is nonstandard and understands a special syntax that is designed to be used with Tcl variables.

Statement parameters can only be used to replace literals. They cannot be used to replace identifiers, such as table or column names. See the section “[Bound Parameters](#)” on page 133 for more details on how to use statement parameters with the C API.

## Logic Representations

SQL and SQLite have a fair number of logic operations. Many of the operators, such as `<=` (test for less-than or equal) perform some type comparison or search between parameter expressions and return a logic value—that is, *true* or *false*. A number of SQL commands use these logic values to control how commands are applied to the database. For example, the `WHERE` clause of a `SELECT` command ultimately computes a logic value to determine if a given row is included in the result set or not.

Despite the fact that logic values are commonly used, SQLite does not have a native logic datatype (such as a Boolean). Rather, logic values are expressed as integer values. Zero is used to represent false, while one (or any other nonzero integer value) is used to represent true.

For other datatypes, SQLite uses the standard conversion rules to translate a text or BLOB value into an integer, before considering if the value is true or false. This means that most nonnumeric strings (such as `'abc'`) will translate to *false*.

The one exception is `NULL`. Next to true and false, `NULL` is considered a third logic state. This necessitates the concept of three valued logic, or 3VL. For the purpose of three valued logic, `NULL` is considered to be an unknown or undefined state. For more details, see “[Three-Valued Logic](#)” on page 31. In general, this means that once a `NULL` is introduced into an expression, it tends to be propagated through the expression. Nearly all unary and binary operators will return `NULL` if any of the parameter expressions are `NULL`.

## Unary Expressions

Unary operators are the simplest type of expression operator. They take a single (or unitary) parameter expression and modify or alter that expression in some way. In all cases, if the parameter expression is `NULL`, the operator will also return `NULL`.

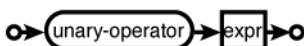

SQLite supports the following unary expression operators:

- *Sign negation*

A unary negative sign will invert the sign of a numeric expression, and is equivalent to being multiplied by -1. Positive expressions become negative, while negative expressions become positive. Any non-NULL parameter expression will be converted into a numeric type before the conversion.

+ *Positive sign*

Logically, this operator is a nonoperation. It does not force numbers to be positive (use the `abs()` SQL function for that), it simply maintains the current sign. It can be used with any datatype, including text and BLOB types, and will simply return the value, without conversion.

Although this operator does not alter the value of the parameter expression, the result expression is still considered a “computed” expression. Applying this operator to a column identifier will dissociate the resulting expression from the source table. This alters the way the query optimizer considers the expression. For example, the optimizer won’t attempt to use any indexes associated with the source column or a computed result column.

~ *Bit inversion*

Inverts or negates all of the bits of the parameter expression. Any non-NULL parameter expression will be converted into an integer before the bit inversion.

NOT *Logic inversion*

The NOT operator is used to invert the meaning of any logic expression. Any non-NULL expression will be converted to an integer value. All nonzero values will return 0, while a 0 value will return 1. Don’t confuse this unary operator with the optional NOT found in some binary operators. The end result is the same, but the syntax ordering is a bit different.

Along with the COLLATE expression, these operators have the highest precedence.

## Binary Expressions

Binary operators take two values as parameter expressions and combine or compare them in some way that produces an output value. This section includes all of the operators with nonkeyword representations, plus AND and OR. With the exception of AND and OR, all of these operators will produce a NULL result if either parameter expression is NULL.

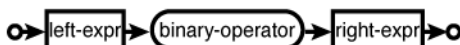



SQLite supports the following binary expression operators:

**||** *String concatenation*

The **||** operator is used to concatenate text values. This operator is defined by the SQL standard. Although some databases support the nonstandard **+** operator for concatenating text values, SQLite does not. Non-NULL parameter expressions will first be converted to text values.

**\*** *Multiplication*

Standard numeric multiplication of two numbers. Non-NULL parameter expressions will first be converted to numeric values. If both expressions are integers, the result will also be an integer.

**/** *Division*

Standard numeric division of two numbers. The result will be the lefthand operator divided by the righthand operator. Non-NULL parameter expressions will first be converted to numeric values. If both expressions are integers, the integer division will be used and the result will also be an integer.

**%** *Modulo or remainder*

Standard numeric modulo of two numbers. The expression value will be the remainder of the left operator divided by the right. If either parameter expression is a real number, the result will be a real number. The result will be a whole number between 0 and one less than the value of the converted righthand expression. Non-NULL parameter expressions will first be converted to numeric values.

**+** *Addition*

Standard numeric addition of two numbers. If both parameter expressions are integers, the result will also be an integer. Non-NULL parameter expressions will first be converted to numeric values.

**-** *Subtraction*

Standard numeric subtraction of two numbers. If both parameter expressions are integers, the result will also be an integer. Non-NULL parameter expressions will first be converted to numeric values.

**<< >>** *Bit shifts*

Binary bit shift. The lefthand expression is shifted right (**>>**) or left (**<<**) by the number of bits indicated in the right operator. Any non-NULL parameter expressions will first be converted into integers. These operators should be familiar to C programmers, but are nonstandard operators in SQL.

**& |** *Binary AND, OR*

Binary AND and OR bitwise operations. Any non-NULL parameter expression will first be converted into integers. Logic expressions should not use these operators, but should use **AND** or **OR** instead. As with bit shifts, these are nonstandard operators.

< <= => > *Greater-than, less-than variations*

Compares the parameter expressions and returns a logic value of 0, 1, or NULL, depending on which expression is greater-than, less-than, or equal-to. Parameter expressions do not need to be numeric, and will not be converted. In fact, they don't even need to be the same type. The results may depend on the collations associated with the parameter expressions.

= == *Equal*

Compares the operands for equality and returns a logic value of 0, 1, or NULL. Like most logic operators, equal is bound by the rules of three valued logic. In specific, NULL == NULL will result in a NULL, not *true* (1). The specific definition of equal for text values depends on the collations associated with the parameter expressions. Both forms (single or double equal sign) are the exact same.

!= <> *Not equal*

Compares the expressions for inequality and returns a logic value of 0, 1, or NULL. Like equal, not equal is also bound by the rules of three valued logic ,so NULL != NULL is NULL, not *false* (0). The specific definition of not equal depends on the collations associated with the parameter expressions. Both forms are the same.

AND OR *Logical AND, OR*

Logical *and* and *or* operators. These can be used to string together complex logic expressions.

The AND and OR operators are some of the only operators that may return an integer logic value when one of their parameter expressions is NULL. See [“Three-Valued Logic” on page 31](#) for more details on how AND and OR operate under three valued logic.

These operators are listed in order of precedence. However, a number of operators have the same precedence as their neighbors. As with most expression languages, SQL allows subexpressions to be enclosed in parentheses to enforce a specific evaluation ordering.

## Function Calls

In addition to operators, SQLite supports both built-in and user-defined function calls. There are two categories of function calls. Scalar functions are called with a specific set of parameters and return a value, just like functions in almost any other expression language. Scalar functions can be used in just about any context in any SQLite expression. An example of a scalar function is `abs()`, which returns the absolute value of a numeric parameter.

There are also aggregate functions, which are used to collapse or summarize groups of rows. Aggregate functions can only be used in expressions that define the result set or `HAVING` clause of a `SELECT` statement. Aggregates are often used in conjunction with `GROUP BY` clauses. In essence, an aggregate function is called many times with different input values, but returns only one value per dataset. An example of an aggregate function is `avg()`, which computes the average value for a sequence of numeric inputs.

The syntax for a function call looks like this:

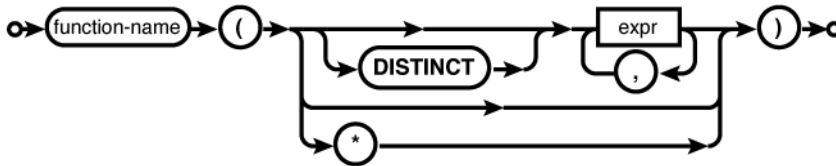

As with many expression languages, a function can be called by naming the function and providing a list of zero or more comma-separated parameter expressions within a set of parentheses. In some contexts, the special syntax of a single `*` character can also be used in place of a parameter list. Like the result set definition of a `SELECT` statement, this has an implied meaning of “everything.”

The optional keyword `DISTINCT` can also be included before the first parameter. This is only relevant for aggregate functions. If present, it will verify that each set of parameters passed in to an aggregate will be unique and distinct. The keyword has no effect when used with scalar functions.

For a full listing of all the built-in functions that SQLite supports, see [Appendix E](#).

## Column Names

One of the most common types of expressions is the column name. The general format is fairly simple, consisting of just the column name. If there is any ambiguity between different tables, you can prefix the column name with an optional table name or a database and table name.

Identifiers (database names, table names, or column names) that include nonstandard characters can be enclosed in double quotes ( `"` ) or square brackets ( `[]` ) to escape them. For example `[table name].[column name]`.

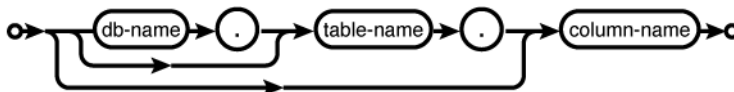

Column name expressions are always evaluated in some type of context. For example, if you're formulating a **WHERE** expression that is part of a **SELECT** statement, the expression defined there will be evaluated once for each possible row in the result set. As each row is processed, the value of the column for that row will be put into the expression and the expression will be evaluated. The context defines what column references are available to any particular expression.

In addition to actual table columns, many expressions within a **SELECT** statement can also reference columns from the result set by referencing the alias assigned in an **AS** clause. Similarly, if a source table in the **FROM** clause is assigned a table alias, this alias must be used in any table reference. The use of table aliases is especially common when formulating join condition expressions on self-joins (a table joined to itself), and other situations when you need to refer to a specific instance of a specific table. A table alias can also be assigned to a nameless subquery.

## General Expressions

This section includes all the keyword expressions. Many of these have unique formats with one or more variations. Syntax diagrams have been provided to help understand the expression format.

---

### AND

Logical AND

See: [“Binary Expressions” on page 346](#), AND

---

### BETWEEN

Inclusion within a range

#### Syntax



#### Description

The **BETWEEN** expression checks to see if the value of a test expression is between a minimum expression and a maximum expression, inclusive. The expression is logically equivalent to  $(\text{test} \geq \text{min} \text{ AND } \text{test} \leq \text{max})$ , although the test expression is only evaluated once. The **BETWEEN** operator will return a logic value of 0, 1, or NULL, under the rules of three valued logic.

#### See Also

[IN](#), [EXISTS](#)

## CASE

Conditional expression evaluation

### Syntax

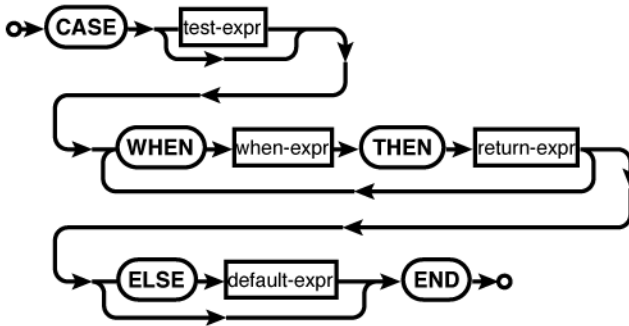

### Example Usage

```

CASE WHEN col IS NULL THEN 'null'
      WHEN NOT col THEN 'false' -- convert to logic value
      WHEN NOT NOT col THEN 'true' -- convert to logic value
      ELSE 'unknown' END
  
```

### Description

The CASE expression is similar to the C `switch` statement, or a series of if-then statements. The expression consists of an optional test expression followed by one or more `WHEN...THEN` clauses. The statement is finished with an optional `ELSE` clause and a required `END` keyword.

Each `WHEN...THEN` clause is evaluated in order. The first `WHEN` expression that is found to be equivalent to the test expression will cause the whole `CASE` expression to take the value of the corresponding return expression. If no equivalent `WHEN` expression is found, the default expression value is used. If no `ELSE` clause is provided, the default expression is assumed to be `NULL`.

If no test expression is given, the first `WHEN` expression that evaluates to `true` will be used.

## CAST

Force a type conversion

### Syntax



## Description

The CAST operator forces the cast expression to the datatype described by type name. The actual representation (integer, real, text, BLOB) will be derived from the type name by searching (case-insensitively) for these specific substrings. The first string that matches will determine the type. If no matches are found, the cast expression will be converted into the most appropriate numeric value.

Substring	Datatype
INT	Integer
CHAR	Text
CLOB	Text
TEXT	Text
BLOB	BLOB
REAL	Float
FLOA	Float
DOUB	Float

Note that the type string `FLOATING POINT` will be interpreted as an integer, and not a real, since the first substring listed will match the `INT` at the end of the name. This first entry takes precedence over subsequent substrings, resulting in an unexpected cast. It is best to use somewhat standard database types to ensure correct conversion.

Once a specific datatype has been determined, the actual conversion is done using the standard rules. See [Table 7-1](#) for specifics.

## See Also

[CREATE TABLE](#) [SQL Cmd, Ap C]

---

## COLLATE

Associate a specific collation to an expression

### Syntax



### Description

The COLLATE operator associates a specific collation with an expression. The COLLATE operator does not alter the value of the expression, but it does change how equality and ordering are tested in the enclosing expression.

If two text expressions are involved in an equality or order test, the collation is determined with the following rules:

1. If the lefthand (first) expression has an explicit collation, that is used.
2. If the righthand (second) expression has an explicit collation, that is used.
3. If the lefthand (first) expression is a direct reference to a column with a collation, the column collation is used.
4. If the righthand (second) expression is a direct reference to a column with a collation, the column collation is used.
5. The default **BINARY** collation is used.

For example:

```
'abc' == 'ABC' => 0 (false)
'abc' COLLATE NOCASE == 'ABC' => 1 (true)
'abc' == 'ABC' COLLATE NOCASE => 1 (true)
'abc' COLLATE NOCASE == 'ABC' COLLATE BINARY => 1 (true)
'abc' COLLATE BINARY == 'ABC' COLLATE NOCASE => 0 (false)
```

For more information on collations, see [“Collation Functions” on page 200](#).

### See Also

[CREATE TABLE](#), [sqlite3\\_create\\_collation\(\)](#) [C API, Ap G]

---

## EXISTS

Test if a row exists

### Syntax

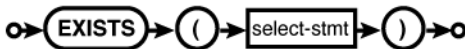

### Description

The EXISTS operator returns a logic value (integer 0 or 1) depending on whether the SELECT statement returns any rows. The number of columns and their values are irrelevant. As long as the SELECT statement returns at least one row consisting of at least one column, the operator will return true—even if the column value is a NULL.

### See Also

[IN](#), [BETWEEN](#)

---

## GLOB

Match text values using patterns

### Syntax

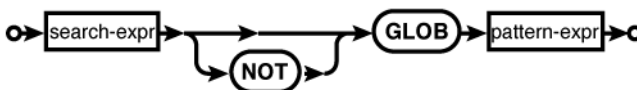

## Description

The GLOB operator is used to match text values against a pattern. If the search expression can be matched to the pattern expression, the GLOB operator will return true (1). All non-NULL parameter expressions will be converted to text values. GLOB is case sensitive, so 'a' GLOB 'A' is false.

The syntax of the pattern expression is based off common command-line wildcards, also known as file-globbing. The \* character in the pattern will match zero or more characters in the search expression. The ? character will match exactly one of any character, while the list wildcard ( [ ] ) will match exactly one character from its set of characters. All other characters within the pattern are taken as literals. GLOB patterns have no escape character.

For example, the pattern '\*.xml' will match all search expressions that end in the four characters .xml, while the pattern '??' will match any text value that is exactly two characters long. The pattern '[abc]' will match any single a, b, or c character.

The list wildcard allows a range of characters to be specified. For example [a-z] will match any single lowercase alphabetic character, while [a-zA-Z0-9] will match any single alphanumeric character, uppercase or lowercase.

You can match any character *except* those indicated in a list by placing a ^ at the beginning of the list. For example, the pattern [^0-9] will match any single character except a numeric character.

To match a literal \*, ?, or [, put them in a list wildcard; for example [\*] or [[]. To match a ^ inside a list, don't put it first. To match (or not match) a literal ] inside a list, make it the first character after the opening [ or ^. To match a literal - inside a range, make it the last character in the list.

The GLOB operator is implemented by the glob() SQL function. As such, its behavior can be overridden by registering a new glob() function.

## See Also

[glob\(\)](#) [SQL Func, Ap E], [LIKE](#), [MATCH](#), [REGEXP](#)

## IN

Test if value is in set

### Syntax

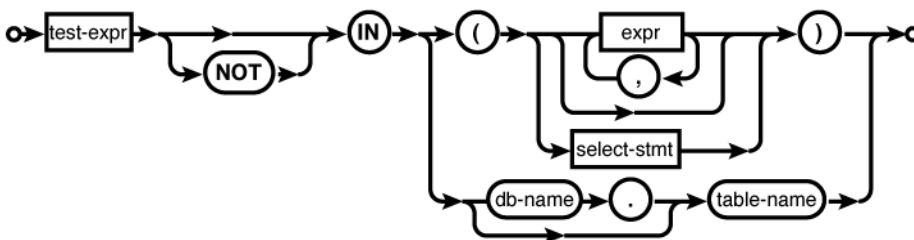



## Common Usage

```
col IN ( test1, test2, test3 )
col IN ( SELECT c FROM t )
col IN temp.in_test
```

## Description

The IN operator tests to see if the test expression equal to (or not equal to) any of the values found on the righthand side of the expression. This is a three valued logic operator and will return 0, 1, or NULL. A NULL will be returned if a NULL is found on the lefthand side, or if a NULL appears anywhere in an unmatched test group.

There are three ways to define the test group. First, an explicit series of zero or more expressions can be given. Second, a subquery can be provided. This subquery must return a single column. The test expression will be evaluated against each row returned by the subquery. Both of these formats require parentheses.

The last way to define the test group is by providing a table name. The table must consist of only a single column. You cannot provide a table and column, it must be a single-column table. This final style is most frequently used with temporary tables. If you need to execute the same test multiple times, it can be more efficient to build a temporary table (for example, with CREATE TEMP TABLE...AS SELECT), and use it over and over, rather than using a subquery as part of the IN expression.

## See Also

[BETWEEN](#), [EXISTS](#)

---

## IS

Equality test, including NULLs

## Syntax

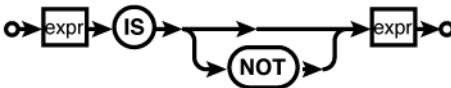

## Description

The IS and IS NOT operators are very similar to the equal (= or ==) and not equal (!= or <>) operators. The main difference is how NULLs are handled. The standard equality tests are subject to the rules of three valued logic, which will result in a NULL if either parameter expression is NULL.

The IS operator considers NULL to be “just another value,” and will always return a 0 or 1. For example, the expression NULL IS NULL is considered to be true (1) and the expression NULL IS 6 is considered to be false (0).

## See Also

[ISNULL](#)

## ISNULL

### Syntax

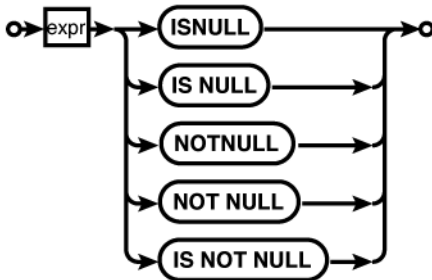

### Description

The ISNULL and other operators shown here are used to test for NULL or non-NULL expressions. They are syntactic variations on IS NULL and IS NOT NULL, which are properly formed IS expressions.

### See Also

[IS](#)

## LIKE

Match text values using patterns

### Syntax

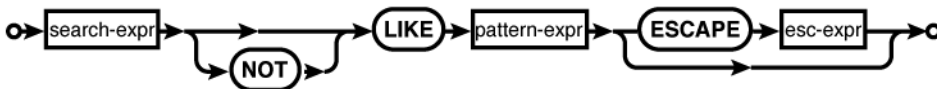

### Description

The LIKE operator is used to match text values against a pattern. If the search expression can be matched to the pattern expression, the LIKE operator will return true (1). All non-NULL parameter expressions will be converted to text values. LIKE is a standardized SQL operator.

By default, LIKE is not case sensitive, so 'a' LIKE 'A' is true. However, this case-insensitivity only applies to standard 7-bit ASCII characters. By default, LIKE is not Unicode aware. See [“ICU Internationalization Extension” on page 167](#) for more info. The case sensitivity of LIKE can be adjusted with the `PRAGMA case_sensitive_like`.

The `LIKE` pattern syntax supports two wildcards. The `%` character will match zero or more characters, while the `_` character will match exactly one. All other characters in the pattern will be taken as literals. A literal `%` or `_` can be matched by preceding it with the character defined in the optional escape expression. The first character of this expression will be used as the escape character. There is no default escape character (in specific, the C-style `\` character is not a default).

For example, the pattern `%.xml` will match all search expressions that end in the four characters `.xml`, while the pattern `'__'` will match any text value that is exactly two characters long. It is not possible to match a literal `%` or `_` without defining an escape character.

The `LIKE` operator is implemented by the `like()` SQL function. As such, its behavior can be overridden by registering a new `like()` function.

### See Also

[like\(\)](#) [SQL Func, Ap E], [case\\_sensitive\\_like](#) [PRAGMA, Ap F], [GLOB](#), [MATCH](#), [REGEXP](#)

---

## MATCH

Match text values using patterns

### Syntax

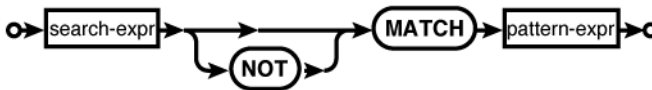

### Description

The purpose of the `MATCH` operator is to support a user-defined pattern-matching algorithm. No default implementation exists, however, so any attempt to use the `MATCH` operator without first defining a `match()` SQL function will result in an error.

### See Also

[match\(\)](#) [SQL Func, Ap E], [LIKE](#), [GLOB](#), [REGEXP](#)

---

## NOTNULL

Test for non-NULL

See: [ISNULL](#)

---

## OR

Logical OR

See: “Binary Expressions” on page 346, [OR](#)

**RAISE**

Indicate an error condition

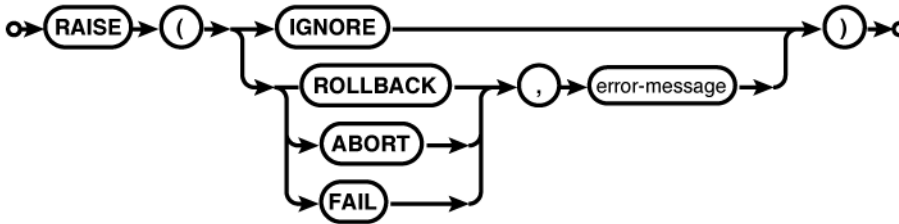
**Syntax****Description**

The RAISE expression isn't an expression in the traditional sense. Rather than producing a value, it provides a means to raise an error exception. The RAISE expression can only be used in the body of a trigger. It is typically used to flag a constraint violation, or some similar problem. It is common to use a RAISE expression in conjunction with a CASE expression, or some other expression that selectively executes subexpressions depending on the logic of the SQL statement.

**See Also**

[CREATE TRIGGER](#) [SQL Cmd, Ap C]

**REGEXP**

Match text values using patterns

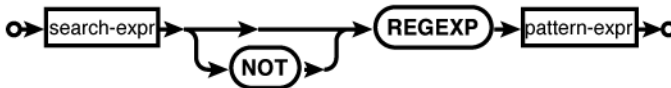
**Syntax****Description**

The purpose of the REGEXP operator is to support a user-defined regular expression text-matching algorithm. No default implementation exists, however, so any attempt to use the REGEXP operator without first defining a `regexp()` SQL function will result in an error. This is typically done using a third-party regular expression library.

**See Also**

[regex\(\)](#) [SQL Func, Ap E], [LIKE](#), [GLOB](#), [MATCH](#)

---

## SELECT

Extract expression value from database

### Syntax

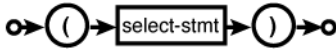

### Description

A **SELECT** expression is a subquery within parentheses. The **SELECT** statement must return only one column. The value of the expression becomes the value of the first row (and only the first row). If no rows are returned, the expression is **NULL**.

SQLite supports several different types of subqueries, so you need to be careful about which style you're using. Several expressions, such as **IN**, allow a direct subquery as part of their syntax. Similarly, several SQL commands, such as **CREATE TABLE**, support a subquery syntax. In these cases, the subquery is returning a set of data, not a single value. When you use this form of a subquery as a standalone expression, it will only return one value.

This can sometimes have unexpected results. For example, consider these two expressions:

```
col IN ( SELECT c FROM t );
col IN ( ( SELECT c FROM t ) );
```

The only difference between these two expressions is the extra set of parentheses around the subquery in the second line. In the first case, the **IN** expression sees the subquery as a direct part of the **IN** expression. This allows the **IN** to test **col** against each row returned by the subquery.

In the second case, the extra set of inner parentheses converts the subquery into an expression. This conversion makes **IN** see a single-value expression list, rather than a subquery. As a result, the **col** expression is only tested against the first row returned by the subquery.

Care must be taken when using parentheses around **SELECT** expressions. Extraneous parentheses shouldn't alter scalar expressions, but if a subquery is part of a larger expression, there can be a critical difference between a subquery and an expression derived from a subquery.

### See Also

[IN](#), [EXISTS](#)



---

# SQLite SQL Function Reference

SQLite includes a number of built-in SQL functions. Many of these functions are pre-dicated by the SQL standard, while others are specific to the SQLite environment.

There are two styles of functions. Scalar functions can be used as part of any SQL expression. They take zero or more parameters and calculate a return value. They can also have side-effects, just like the functions of most programming languages.

Aggregate functions can only be used in **SELECT** header expressions and **HAVING** clauses. Aggregate functions combine column values from multiple rows to calculate a single return value. Often, aggregate functions are used in conjunction with a **GROUP BY** clause.

This appendix is divided into two sections. The first section covers all the built-in scalar functions, while the second section covers all the built-in aggregate functions. You can also define your own scalar or aggregate functions. See [Chapter 9](#) for more details.

## Scalar Functions

---

**abs()**

Compute the numerical absolute value

**Common Usage**`abs( expression )`**Description**

The **abs()** function returns the absolute value of an expression. If the expression is an integer, an integer absolute value is returned. If expression is a float, the floating-point absolute value is returned. If number is **NULL**, a **NULL** is returned. All other datatypes are first converted to floating-point values, then the absolute value of the converted floating-point number is returned.

changes()

---

## changes()

Get the number of rows changed by the last SQL command

### Common Usage

changes( )

### Description

The `changes()` function returns an integer that indicates the number of database rows that were modified by the most recently completed `INSERT`, `UPDATE`, or `DELETE` command run by this database connection.

This SQL function is a wrapper around the C function `sqlite3_changes()`, and has all of the same limitations and conditions.

### See Also

[total\\_changes\(\)](#), [last\\_insert\\_rowid\(\)](#), [sqlite3\\_changes\(\)](#) [C API, Ap G]

---

## coalesce()

Return first non-NULL argument

### Common Usage

coalesce( *param1*, *param2*, ... )

### Description

The `coalesce()` function takes two or more parameters and returns the first non-NULL parameter. If all of the parameter values are NULL, a NULL is returned.

### See Also

[ifnull\(\)](#), [nullif\(\)](#)

---

## date()

Decode time string into date

### Common Usage

date( *timestring*, *modifier*, ... )

### Description

The `date()` function takes a *timestring* value plus zero or more modifier values and returns a text value in the format `YYYY-MM-DD`. It is equivalent to the call `strftime( '%Y-%m-%d', timestring, ... )`.

### See Also

[strftime\(\)](#), [datetime\(\)](#), [time\(\)](#)



---

## datetime()

Decode time string into date and time

### Common Usage

```
datetime( timestring, modifier, ... )
```

### Description

The `datetime()` function takes a *timestring* value plus zero or more modifier values and returns a text value in the format `YYYY-MM-DD HH:MM:SS`. It is equivalent to the call `strftime( '%Y-%m-%d %H:%M:%S', timestring, ... )`.

### See Also

[strftime\(\)](#), [date\(\)](#), [time\(\)](#)

---

## glob()

Implement the GLOB operator

### Common Usage

```
glob( pattern, string )
```

### Description

The `glob()` function implements the matching algorithm used by the SQL expression *string* GLOB *pattern*, and is normally not called directly by user-provided SQL expressions. This function exists so that it may be overridden with a user-defined SQL function, providing a user-defined GLOB operator.

Note that the order of the parameters differs between the GLOB expression and the `glob()` function.

### See Also

[GLOB](#) [SQL Expr, Ap D], [like\(\)](#), [match\(\)](#), [regex\(\)](#)

---

## ifnull()

Return first non-NULL argument

### Common Usage

```
ifnull( param1, param2 )
```

### Description

The `ifnull()` function is basically a fixed two-parameter version of `coalesce()`. If *param1* is not NULL, it is returned. If *param1* is NULL, *param2* is returned.

### See Also

[coalesce\(\)](#), [nullif\(\)](#)

hex()

---

## hex()

Dump BLOB as hexadecimal

### Common Usage

hex( *data* )

### Description

The hex() function converts a BLOB value into a hexadecimal text representation. The parameter *data* is assumed to be a BLOB. If it is not a BLOB, it will be converted into one. The returned text value will contain two hexadecimal characters for each byte in the BLOB.

Be careful about using hex() with large BLOBs. The UTF-8 text representation is twice as big as the original BLOB value, and the UTF-16 representation is four times as large.

### See Also

[quote\(\)](#)

---

## julianday()

Return the Julian Day number

### Common Usage

julianday( *timestring*, *modifier*, ... )

### Description

The julianday() function takes a *timestring* value plus zero or more modifier values and returns a floating-point value representing the number of days since noon, Greenwich time, on November 24th, 4714 B.C. using the proleptic Gregorian calendar. It is equivalent to the call strftime( '%J', *timestring*, ... ), except that julianday() returns a floating-point value, while strftime( '%J', ... ) returns a text representation of an equivalent floating-point value.

### See Also

[strftime\(\)](#)

---

## last\_insert\_rowid()

Return the ROWID of the last inserted row

### Common Usage

last\_insert\_rowid( )

### Description

The last\_insert\_rowid() function returns the integer ROWID value (or ROWID alias) of the last successfully completed row INSERT. The purpose of this function is to discover an automatically generated ROWID, often for the purpose of inserting a foreign key that references that ROWID. For the purposes of this function, an INSERT is considered to successfully complete even if it happens inside an uncommitted transaction.

The returned value is tracked by the database connection, not the database itself. This avoids any possible race conditions between `INSERT` operations done from different database connections. It means, however, that the returned value is updated by an `INSERT` to any table of any attached database in the database connection. If no `INSERT` operations have completed with this database connection, the value 0 is returned.

This SQL function is a wrapper around the C function `sqlite3_last_insert_rowid()`, and has all of the same limitations and conditions.

### See Also

[changes\(\)](#), [total\\_changes\(\)](#), [sqlite3\\_last\\_insert\\_rowid\(\)](#) [C API, Ap G]

## length()

Return the number of characters in a string

### Common Usage

```
length( data )
```

### Description

The `length()` function returns an integer value indicating the length of its parameter. If `data` is a text value, the number of characters is returned, regardless of encoding. If `data` is a BLOB value, the number of bytes in the BLOB are returned. If `data` is NULL, a NULL is returned. Numeric types are first converted to a text value.

## like()

Implement the LIKE operator

### Common Usage

```
like( pattern, string )
```

### Description

The `like()` function implements the matching algorithm used by the SQL expression `string LIKE pattern`, and is normally not called directly by user-provided SQL expressions. This function exists so that it may be overridden with a user-defined SQL function, providing a user-defined LIKE operator.

Note that the order of the parameters differs between the LIKE expression and the `like()` function.

### See Also

[LIKE](#) [SQL Expr, Ap D], [glob\(\)](#), [match\(\)](#), [regex\(\)](#)

---

## load\_extension()

Load a dynamically linked SQLite extension

### Common Usage

```
load_extension( extension )  
load_extension( extension, entry_point )
```

### Description

The `load_extension()` function attempts to load and dynamically link the file *extension* as an SQLite extension. The function named *entry\_point* is called to initialize the extension. If *entry\_point* is not provided, it is assumed to be `sqlite3_extension_init`. Both parameters should be text values.

This SQL function is a wrapper around the C function `sqlite3_load_extension()`, and has all of the same limitations and conditions. In specific, extensions loaded this way cannot redefine or delete function definitions.

### See Also

[sqlite3\\_load\\_extension\(\)](#) [C API, Ap G]

---

## lower()

Convert all ASCII characters to lowercase

### Common Usage

```
lower( text )
```

### Description

The `lower()` function returns a copy of *text* with all of the letter characters converted to lowercase. The built-in implementation of this function only works with ASCII characters (those that have a value less than 128).

The ICU extension provides a Unicode-aware implementation of `lower()`.

### See Also

[upper\(\)](#)

---

## ltrim()

Trim characters from the front (left) of a string

### Common Usage

```
ltrim( text )  
ltrim( text, extra )
```

### Description

The `ltrim()` function returns a copy of *text* that has been stripped of any prefix that consists solely of characters from *extra*. Characters from *extra* that are contained in the body of *text* remain untouched.

If *extra* is not provided, it is assumed to consist of the ASCII space (0x20) character. By default, tab characters and other whitespace are not trimmed.

### See Also

[rtrim\(\)](#), [trim\(\)](#)

## match()

Implement the MATCH operator

### Common Usage

```
match( pattern, string )
```

### Description

The `match()` function implements the matching algorithm used by the SQL expression `string MATCH pattern`, and is normally not called directly by user-provided SQL expressions. A default implementation of this function does not exist. To use the MATCH operator, an application-defined function must be registered.

Note that the order of the parameters differs between the MATCH expression and the `match()` function.

### See Also

[MATCH](#) [SQL Expr, Ap D], [like\(\)](#), [glob\(\)](#), [regex\(\)](#)

## max()

Return the argument with the largest value

### Common Usage

```
max( param1, param2, ... )
```

### Description

Given two or more parameters, the `max()` function returns the parameter with the largest value. If any parameter is a NULL, a NULL will be returned. Otherwise, BLOB values are considered to have the largest value, followed by text values. These are followed by the numeric types (mixed integer values and floating-point values), sorted together in their natural order.

If you want the comparison to use a specific collation, use a COLLATE expression to attach an explicit collation to the input values. For example, `max( param1 COLLATE NOCASE, param2 )`.

There is also an aggregate version of `max()` that takes a single parameter.

### See Also

[min\(\)](#) [Agg SQL Func], [max\(\)](#) [Agg SQL Func], [COLLATE](#) [SQL Expr, Ap D]

min()

---

## min()

Return the argument with the smallest value

### Common Usage

```
min( param1, param2, ... )
```

### Description

Given two or more parameters, the `min()` function will return the parameter with the smallest value. If any parameter is a `NULL`, a `NULL` will be returned. Otherwise, numeric types (mixed integers and floating-point) are considered smallest, sorted together in their natural order. These are followed by text values, which are followed by `BLOB` values.

If you want the comparison to use a specific collation, use a `COLLATE` expression to attach an explicit collation to the input values. For example, `min( param1 COLLATE NOCASE, param2 )`.

There is also an aggregate version of `min()` that takes a single parameter.

### See Also

[max\(\)](#), [min\(\)](#), [COLLATE](#) [SQL Expr, Ap D]

---

## nullif()

Return `NULL` if parameters are equal

### Common Usage

```
nullif( param1, param2 )
```

### Description

The `nullif()` function returns `NULL` if the parameters are equal. If the two parameters are not equal, the first parameter is returned. If both parameters are `NULL`, a `NULL` is returned.

### See Also

[ifnull\(\)](#), [coalesce\(\)](#)

---

## quote()

Return the SQL literal representation of a value

### Common Usage

```
quote( value )
```

### Description

The `quote()` function returns a text value that represents the SQL literal representation of `value`. Numbers are returned in their string representation with enough digits to preserve precision. Text values are returned inside single quotes with any internal single quote characters properly escaped. `BLOB`s are returned as hexadecimal literals. `NULL`s are returned as the string `NULL`.

In SQLite v3.6.23.1 and earlier, this function was used internally by `VACUUM`. It is strongly recommended that the default implementation is not overridden.

**See Also**

[hex\(\)](#), [VACUUM](#) [SQL Cmd, Ap C]

**random()**

Return a random 64-bit signed integer

**Common Usage**

`random( )`

**Description**

The `random()` function returns a pseudo-random, 64-bit signed integer value. This produces a number within the range -9,223,372,036,854,775,808 to +9,223,372,036,854,775,807. These values are generated by an automatically seeded internal pseudo-random number generator to insure quality.

**See Also**

[randblob\(\)](#)

**randblob()**

Return a BLOB consisting of random data

**Common Usage**

`randblob( size )`

**Description**

The `randblob()` function returns a BLOB value consisting of *size* bytes. All of the bytes are set to pseudo-random values. These values are generated by an automatically seeded internal pseudo-random number generator to insure quality.

**See Also**

[random\(\)](#), [zeroblob\(\)](#)

**regex()**

Implement the REGEX operator

**Common Usage**

`regex( pattern, string )`

**Description**

The `regex()` function implements the matching algorithm used by the SQL expression *string* REGEX *pattern*, and is normally not called directly by user-provided SQL expressions. A default implementation of this function does not exist. To use the REGEX operator, an application defined function must be provided.

replace()

Note that the order of the parameters differs between the REGEX expression and the `regex()` function.

### See Also

[REGEXP](#) [SQL Expr, Ap D], [like\(\)](#), [glob\(\)](#), [match\(\)](#)

---

## replace()

Find and replace substrings

### Common Usage

```
replace( value, search, replacement )
```

### Description

The `replace()` function returns a copy of *value* with each instance of the *search* substring replaced by *replacement*. If any of the parameters are NULL, a NULL will be returned. If *search* is an empty string, *value* will be returned unmodified. Otherwise, all parameters will be converted into text values.

The `replace()` function also works on BLOB values, although the result is returned as a text value and must be cast back to a BLOB.

### See Also

[substr\(\)](#)

---

## round()

Round off numeric values

### Common Usage

```
round( value )  
round( value, precision )
```

### Description

The `round()` function returns a floating-point value that represents *value* rounded to *precision* base-10 digits after the decimal point. The *value* parameter is assumed to be a floating-point value, while *precision* is assumed to be a positive integer. Values are rounded to the closest representation, not towards zero.

If either *value* or *precision* is NULL, a NULL will be returned. If *precision* is omitted, it is assumed to be zero. This will result in a whole number, although it will still be returned as a floating-point value.

---

## rtrim()

Trim characters from the end (right) of a string

### Common Usage

```
rtrim( text, extra )  
rtrim( text )
```



## Description

The `rtrim()` function returns a copy of *text* that has been stripped of any suffix that consists solely of characters from *extra*. Characters from *extra* that are contained in the body of *text* remain untouched.

If *extra* is not provided, it is assumed to consist of the ASCII space (0x20) character. By default, tab characters and other whitespace are not trimmed.

## See Also

[ltrim\(\)](#), [trim\(\)](#)

## sqlite\_compileoption\_get()

Access list of compile-time options used to build the SQLite library

### Common Usage

```
sqlite_compileoption_get( index )
```

## Description

The `sqlite_compileoption_get()` function returns a text value that describes one of the build directives used when building this instance of the SQLite library. By iterating over index values (starting with zero), you can view the entire list of directives. Returned values will be in the format `directive_name` if the directive is a simple on/off flag, or `directive_name=value` if the directive is used to set a value. The `SQLITE_` prefix will not be included in the returned value. If the index is negative or out of range, `sqlite_compileoption_get()` will return NULL.

Those directives used to set default values and maximum limits will not be reported. If the directive has a value associated with it, the format will be *name=value*.

This SQL function is a wrapper around the C function `sqlite3_compileoption_get()`, and has all of the same limitations and conditions.

## See Also

[sqlite\\_compileoption\\_used\(\)](#), [sqlite3\\_compileoption\\_get\(\)](#) [Ap G], [sqlite3\\_limit\(\)](#) [Ap G]

## sqlite\_compileoption\_used()

See if compile-time option was used to build the SQLite library

### Common Usage

```
sqlite_compileoption_used( option_name )
```

## Description

Given a build directive name as a text value, the `sqlite_compileoption_used()` function returns a 1 if the directive was used when building this instance of the SQLite library. This function will only indicate if the directive was used, it will not indicate what (if any) value was set. If the given directive was not used, or is otherwise unrecognized, this function will return 0. The `SQLITE_` prefix on the directive name is optional.

`sqlite_source_id()`

Those directives used to set default values and maximum limits will not be reported. If the directive has a value associated with it, you can check for a specific value by searching for the full format *name=value*. If both the name and the value match, a 1 will be returned.

This SQL function is a wrapper around the C function `sqlite3_compileoption_used()`, and has all of the same limitations and conditions.

### See Also

[sqlite\\_compileoption\\_get\(\)](#), [sqlite3\\_compileoption\\_used\(\)](#) [C API, Ap G]

---

## sqlite\_source\_id()

Return the source identification value of the current SQLite library

### Common Usage

```
sqlite_source_id( )
```

### Description

The `sqlite_source_id()` function returns a text value consisting of the check-in identifier of the source code used to build the SQLite library. The identifier consists of a date, timestamp, and an SHA1 hash of the source from the source repository.

This SQL function is a wrapper around the C function `sqlite3_sourceid()`, and has all of the same limitations and conditions.

### See Also

[sqlite\\_version\(\)](#), [sqlite3\\_sourceid\(\)](#) [C API, Ap G]

---

## sqlite\_version()

Return the version string of the current SQLite library

### Common Usage

```
sqlite_version( )
```

### Description

The `sqlite_version()` function returns a text value consisting of the version number of the SQLite library. A typical string would be something like '3.7.2'.

This SQL function is a wrapper around the C function `sqlite3_libversion()`, and has all of the same limitations and conditions.

### See Also

[sqlite\\_source\\_id\(\)](#), [sqlite3\\_libversion\(\)](#) [C API, Ap G]

---

## strftime()

Decode time string into any format

### Common Usage

```
strftime( format, timestring, modifier1, modifier2, ... )
```

## Description

The `strftime()` function returns a formatted string by taking a *timestamp* (with modifiers) and formatting it according to *format*, a `printf()` style format specification. If any of the parameters are in an incorrect or illegal format, a NULL is returned.

The *format* string can contain any of the following markers:

- %d — day of the month (*DD*), 01-31
- %f — seconds with fractional part (*SS.sss*), 00-59 plus decimal portion
- %H — hour (*HH*), 00-23
- %j — day of the year (*NNN*), 001-366
- %J — Julian Day number (*DDDDDDD.ddddddd*)
- %m — month (*MM*), 01-12
- %M — minute (*MM*), 00-59
- %s — seconds since 1970-01-01 (Unix epoch)
- %S — seconds (*SS*), 00-59
- %w — day of the week (*N*), starting with Sunday as 0
- %W — week of the year (*WW*), 00-53
- %Y — year (*YYYY*)
- %% — a literal %

The *timestamp* value can be in any of these formats:

- *YYYY-MM-DD*
- *YYYY-MM-DD HH:MM*
- *YYYY-MM-DD HH:MM:SS*
- *YYYY-MM-DD HH:MM:SS.sss*
- *YYYY-MM-DDTHH:MM*
- *YYYY-MM-DDTHH:MM:SS*
- *YYYY-MM-DDTHH:MM:SS.sss*
- *HH:MM*
- *HH:MM:SS*
- *HH:MM:SS.sss*
- *now*
- *DDDDDDD*
- *DDDDDDD.ddddddd*

strftime()

All hour values use a 24-hour clock. Any value that is not given will be implied. Any implied hour, minute, second, or subsecond is zero. Any implied month or day of month is 1. Any implied year is 2000. The full date and time formats allow either a space or a literal uppercase T between the date and time. The last two values (a single, large integer or floating-point number) provide the date (or date and time) as expressed in Julian Days.

Before formatting, the *timestring* value is processed by one or more modifiers. The modifiers are processed one at a time in the order they are given. The date is normalized after each modifier is applied.

Modifiers can be in the following formats:

- [+ -]NNN day[s]
- [+ -]NNN hour[s]
- [+ -]NNN minute[s]
- [+ -]NNN second[s]
- [+ -]NNN.nnn second[s]
- [+ -]NNN month[s]
- [+ -]NNN year[s]
- start of month
- start of year
- start of day
- weekday *N*
- unixepoch
- localtime
- utc

The first set of modifiers adds or subtracts a given unit of time from the original *timestring* value. For example, the call `date( '2001-01-01', '+2 days' )` will return '2001-01-03'. Manipulations are done at a very literal level, and the dates are normalized to legal values after each modifier is applied. For example, `date( '2001-01-01', '-2 days' )` returns '2000-12-30'.

The normalization process can cause some unexpected results. For example, consider `date( '2001-01-31', '+1 month' )`. This initially calculates the date '2001-02-31', or February 31st. Since February never has 31 days, this date is normalized into the month of March. In the case of 2001 (a nonleap year) the final result is '2001-03-03'. It is also significant that normalization is done after each modifier is applied. For example, the call `date( '2001-01-31', '+1 month', '-1 month' )` will result in '2001-02-03'.

The `start of...` modifiers set all time units that are smaller than the named unit to their minimum value. For example, `datetime( '2001-02-28 12:30:59', 'start of month' )` will result in `'2001-02-01 00:00:00'` by setting everything smaller than a month (day, hour, minute, second) to its minimum value.

The `weekday` modifier shifts the current date forward in time anywhere from zero to six days, so that the day will fall on the *N*th day of the week (Sunday = 0).

The `unixepoch` modifier only works as an initial modifier, and only when the date is given as a single numeric value. This modifier forces the date to be interpreted as a Unix epoch counter, rather than the traditional Julian Day.

The SQLite date/time functions do not keep track of time zone data. Unless otherwise specified, all dates are assumed to be in UTC. For example, the `'now'` *timestamp* will produce date and time values in UTC. To convert a UTC timestamp to the local time, the modifier `local time` can be applied. Conversely, if the *timestamp* is known to be in reference to the local time zone, the `utc` modifier can be used to convert the timestamp to UTC.

All date and time functions are designed to operate on dates between `0000-01-01 00:00:00` and `9999-12-31 23:59:59` (Julian Day numbers 1721059.5 to 5373484.5). Any use of values outside of this range may result in undefined behavior. Unix epoch values are only valid through the date/time `5352-11-01 10:52:47`.

### See Also

[date\(\)](#), [time\(\)](#), [datetime\(\)](#), [julianday\(\)](#)

## substr()

Extract a substring

### Common Usage

```
substr( string, index, count )
substr( string, index )
```

### Description

The `substr()` function extracts and returns a substring from *string*. The position of the substring is determined by *index* and its length is determined by *count*.

If any parameter is NULL, a NULL will be returned. Otherwise, if *string* is not a BLOB it will be assumed to be a text value. The *index* and *count* parameters will be interpreted as integers. If *count* is not given, it will effectively be set to an infinitely large positive value.

If *index* is positive, it is used to index characters from the beginning of *string*. The first character has an index of 1. If *index* is negative, it is used to index characters from the end of *string*. In that case, the last character has an index of -1. An *index* of 0 will result in undefined behavior.

time()

If *count* is positive, then *count* number of characters, starting with the indexed character, will be included in the returned substring. If *count* is negative, the returned substring will consist of *count* number of characters, ending with the indexed character. The returned substring may be shorter than *count* if the indexed position is too close to the beginning or end of *string*. A *count* of zero will result in an empty string.

This function can also be used on BLOB values. If *string* is a BLOB, both the *index* and *count* values will refer to bytes, rather than characters, and the returned value will be a BLOB, rather than a text value.

### See Also

[replace\(\)](#)

---

## time()

Decode time string into time of day

### Common Usage

```
time( timestring, modifier, ... )
```

### Description

The `time()` function takes a *timestring* value plus zero or more modifier values and returns a text value in the format 'HH:MM:SS'. It is equivalent to the call `strftime( '%H:%M:%S', time string, ... )`.

### See Also

[strftime\(\)](#), [datetime\(\)](#), [date\(\)](#)

---

## total\_changes()

Return the total number of rows changed

### Common Usage

```
total_changes( )
```

### Description

The `total_changes()` function returns an integer that indicates the number of database rows that have been modified by any complete `INSERT`, `UPDATE`, or `DELETE` command run by this database connection since it was opened.

This SQL function is a wrapper around the C function `sqlite3_total_changes()`, and has all of the same limitations and conditions.

### See Also

[changes\(\)](#), [last\\_insert\\_rowid\(\)](#), [sqlite3\\_total\\_changes\(\)](#) [C API, Ap G]

---

**trim()**

Trim characters from both ends of a string

**Common Usage**

```
trim( text )  
trim( text, extra )
```

**Description**

The `trim()` function returns a copy of *text* that has been stripped of any prefix or suffix that consists solely of characters from *extra*. Characters from *extra* that are contained in the body of *text* remain untouched.

If *extra* is not provided, it is assumed to consist of the ASCII space (0x20) character. By default, tab characters and other whitespace are not trimmed.

**See Also**

[ltrim\(\)](#), [rtrim\(\)](#)

---

**typeof()**

Return the datatype of a value

**Common Usage**

```
typeof( param )
```

**Description**

The `typeof()` function returns a text value indicating the native datatype of *param*. Possible return values include `null`, `integer`, `real`, `text`, and `blob`.

**See Also**

[CAST](#) [SQL Expr, Ap D]

---

**upper()**

Convert all ASCII characters to uppercase

**Common Usage**

```
upper( text )
```

**Description**

The `upper()` function returns a copy of *text* with all of the letter characters converted to uppercase. The built-in implementation of this function only works with ASCII characters (those that have a value of less than 128).

The ICU extension provides a Unicode aware implementation of `upper()`.

**See Also**

[lower\(\)](#)

zeroblob()

---

## zeroblob()

Return a BLOB consisting of zeroed-out bytes

### Common Usage

```
zeroblob( size )
```

### Description

The `zeroblob()` function returns a BLOB value consisting of *size* bytes. All of the bytes are set to the value zero.

The actual BLOB value is not instantiated into memory. This makes it safe to create BLOB values that are larger than the environment can handle. This function is most commonly used to create new BLOB values as part of an `INSERT` or `UPDATE`. Once the properly sized BLOB value has been recorded into the database, the incremental BLOB I/O API can be used to access or update subsections of the BLOB value.

### See Also

[randblob\(\)](#)

## Aggregate Functions

---

## avg()

Compute the numerical average

### Common Usage

```
avg( number )
```

### Description

The `avg()` aggregate computes the average (mean) numeric value for all non-NULL *number* values. The aggregate attempts to convert any text or BLOB values into a numeric value. If a conversion is not possible, those rows will be counted with a value of 0.

If all the *number* values are NULL, `avg()` will return a NULL.

### See Also

[count\(\)](#), [sum\(\)](#), [total\(\)](#)

---

## count()

Count the number of rows

### Common Usage

```
count( expression )  
count( * )
```



## Description

The `count()` aggregate counts the number of rows with a non-NULL *expression*. If *expression* is given as an asterisk character (\*), the total number of rows in an aggregate group will be returned, regardless of value. In some situations, the computation for the `count( * )` syntax can be optimized and the result value can be computed without an actual data scan.

## See Also

[sum\(\)](#), [total\(\)](#)

## group\_concat()

Concatenate row values

## Common Usage

```
group_concat( element )
group_concat( element, separator )
```

## Description

The `group_concat()` aggregate returns a text value that is the concatenated text representations of each non-NULL *element*, separated by *separator*.

If *separator* is not provided, it is assumed to be the single-character string “,” (comma) without any trailing space.

## max()

Return the largest value

## Common Usage

```
max( value )
```

## Description

The `max()` aggregate returns the largest non-NULL *value*. This is typically used to find the largest numeric value, but the aggregate will sort through all types of data. BLOB values are considered to have the largest value, followed by text values. These are followed by the numeric types (mixed integer values and floating-point values) that are sorted together in their natural order.

If no non-NULL *value* is found, `max()` will return a NULL.

There is also a scalar version of `max()` which takes two or more parameters.

## See Also

[min\(\)](#) [Scalar SQL Func], [max\(\)](#) [Scalar SQL Func]

min()

---

## min()

Return the smallest value

### Common Usage

`min( value )`

### Description

The `min()` aggregate returns the smallest non-NULL *value*. This is typically used to find the smallest numeric value, but the aggregate will sort through all types of data. Numeric types (mixed integers and floating-point) are considered smallest, and will be sorted together in their natural order. These are followed by text values, which are followed by BLOB values.

If no non-NULL *value* is found, `min()` will return a NULL.

There is also a scalar version of `min()` which takes two or more parameters.

### See Also

[max\(\)](#), [min\(\)](#)

---

## sum()

Return the numerical summation

### Common Usage

`sum( number )`

### Description

The `sum()` aggregate computes the sum or total of all the non-NULL *number* values. Any non-NULL *number* that is not an integer will be interpreted as a floating-point value.

If all non-NULL *number* values are integers, `sum()` will return an integer. Otherwise, `sum()` will return a floating-point value. If no non-NULL *number* is found, `sum()` will return NULL.

### See Also

[total\(\)](#), [count\(\)](#)

---

## total()

Return the numerical total

### Common Usage

`total( number )`

### Description

The `total()` aggregate computes the sum or total of all the non-NULL *number* values. Any non-NULL *number* that is not an integer will be interpreted as a floating-point value. The `total()` aggregate is specific to SQLite.

Unlike `sum()`, the `total()` aggregate will *always* return a floating-point value. Even if all *number* expressions are NULL, `total()` will still return a 0.0.

### See Also

[sum\(\)](#), [count\(\)](#)

---

## SQLite SQL PRAGMA Reference

This appendix covers all of the **PRAGMA** commands recognized by SQLite. Pragmas are SQLite-specific statements used to control various environmental variables and state flags within the SQLite environment. They are typically used to activate or configure many of the optional or advanced features of the SQLite library.

Although some pragmas are read-only, most pragma commands can be used to query the current value or set a new value. To query the current value, just provide the name of the pragma:

```
PRAGMA pragma_name;
```

In most cases this will return a one-column, one-row result set with the current value. To set a new value, use a syntax like this:

```
PRAGMA pragma_name = value;
```

Although a few pragmas will return the updated value, in most cases the set syntax will not return anything. Any unrecognized or malformed pragma will silently return without error. Be very careful about spelling your pragma commands correctly, or SQLite will consider the pragma unrecognized—an application bug that can be extremely difficult to find and fix.

Nearly all pragmas fall into one of two categories. The first category includes pragmas that are associated with the database connection. These pragma values can modify and control how the SQLite engine, as a whole, interacts with all of the databases attached to the database connection.

The second category of pragmas operate on specific databases. These pragmas will typically allow different values for each database that has been opened or attached to a database connection. Most database-specific identifiers will only last the lifetime of the database connection. If the database is detached and reattached (or closed and reopened), the pragma will assume the default value. There are a few pragmas, however, that will cause a change that is recorded into the database file itself. These values will typically persist across database connections. In both cases, the default values can typically be altered with compile-time directives.

The syntax for database-specific pragmas is somewhat similar to database-specific identifiers used elsewhere in SQL, and uses the logical database name, followed by a period, followed by the pragma command:

```
PRAGMA database.pragma_name;  
PRAGMA database.pragma_name = value;
```

Like identifiers, if a logical database name is not given, most pragmas will assume it to be `main`. This is the database that was used to open the initial database connection. There are a few exceptions to this syntax, so read the documentation carefully.

A number of pragma values are simple true/false Boolean values or on/off state values. In this appendix, these values are referred to as “switches.” To set a switch, several different values are recognized:

True or On values	False or Off values
1	0
YES	NO
TRUE	FALSE
ON	OFF

A switch pragma will almost always return a simple integer value of 0 or 1.

Generally, any value that consists of a numeric value or constant (such as `TRUE`) can be given without quotes. Known identifiers, such as an attached database name or a table name, can also be given without quotes—unless they contain reserved characters. In that case, they should be given in double quotes, similar to how you would use them in any other SQL command. Other text values, such as filesystem path names, should be placed in single quotes.

There are also a handful of read-only pragmas that return a full multicolumn, multirow result set. These results can be processed in code the same way a `SELECT` result is processed, using repeated calls to `sqlite3_step()` and `sqlite3_column_xxx()`. A few of these pragmas require additional parameters, which are put in parentheses, similar to a function call. For example, here is the syntax for the `table_info` pragma:

```
PRAGMA database.table_info( table_name );
```

For more specifics, see the individual pragma descriptions.

A number of the pragmas control database values that cannot be changed once the database has been initialized. For example, the `page_size` pragma must be set before the database structure is written to disk. This may seem like a bit of a chicken-and-egg problem, since you need to open or attach a database in order to configure it, but opening it creates the database.

Thankfully, the database file header is usually not initialized and actually written to disk until it is absolutely required. This delay in the initialization allows a blank database file to be created by opening or attaching a new file. As long as the relevant pragmas are all set before the database is used, everything works as expected. Generally, it is the first `CREATE TABLE` statement that triggers an initialization. The other case is attaching an additional database. The `main` database (the one opened to create the database connection) must be initialized before any other database is attached to the database connection. If the main database is uninitialized, executing an `ATTACH` command will first force an initialization of the `main` (and only the `main`) database.

One final caution when using pragma statements from the C API. Exactly how and when a pragma takes effect is very dependent on the specific pragma and how it is being used. In some cases, the pragma will cause a change when the pragma statement is prepared. In other cases, you must step through the statement. Exactly how and when the pragmas do their thing is dependent on the particular pragma, and has been known to change from one release of SQLite to another. As a result, it is suggested that you do not pre-prepare pragma statements, like you might do with other SQL statements. Rather, any pragma statement should be prepared, stepped, and finalized in a single pass, when you want the pragma to take effect. When using a static pragma statement, it would also be perfectly safe to use `sqlite3_exec()`.

## SQLite PRAGMAS

---

### auto\_vacuum

Configure automatic vacuum settings

#### Common Usage

```
PRAGMA [database.]auto_vacuum;
PRAGMA [database.]auto_vacuum = mode;
```

#### Description

The `auto_vacuum` pragma gets or sets the auto-vacuum mode. The mode can be any of the following:

Values	Meaning
0 or NONE	Auto-vacuum is disabled
1 or FULL	Auto-vacuum is enabled and fully automatic
2 or INCREMENTAL	Auto-vacuum is enabled but must be manually activated

The set mode can be either the name or the integer equivalent. The returned value will always be an integer.

By default, databases are created with an auto-vacuum mode of **NONE**. In this mode, when the contents of a database page are deleted, the page is marked as free and added to the free-page list. This is the only action that is taken, meaning that a database file will never shrink in size unless it is manually vacuumed using the **VACUUM** command.

Auto-vacuum allows a database file to shrink as data is removed from the database. In **FULL** auto-vacuum mode, free pages are automatically swapped with an active page at the end of the database file. The file is then truncated to release the unused space. In **FULL** mode, a database should never have pages on the free list.

The ability to move pages is key to the auto-vacuum system. In order to accomplish this, the database needs to maintain some extra data that allows a page to back-track references. In the event the page needs to be moved, references to the page can also be updated. Keeping all the reference data up to date consumes some storage space and processing time, but it is reasonably small.

Swapping free pages and updating references also consumes processing time, and in **FULL** mode this is done at the end of every transaction. In **INCREMENTAL** mode, the reference data is maintained, but free pages are not swapped or released—they are simply put on the free list. The pages can be recovered using the `incremental_vacuum` pragma. This is much faster than a full **VACUUM**, and allows for partial recovery of space on demand. It can also be done without any additional free space.

The mode can be changed between **FULL** and **INCREMENTAL** at any time. If the database is in **INCREMENTAL** mode and is switched to **FULL** mode, any pages on the free list will automatically be recovered. Because the **FULL** and **INCREMENTAL** modes require the extra data that **NONE** does not maintain, it is only possible to move from **NONE** to **FULL** or **INCREMENTAL** before the database is initialized. Once the database has been initialized, the only way to move away from **NONE** is to set the pragma and do a **VACUUM**. Similarly, the only way to move from **FULL** or **INCREMENTAL** to **NONE** is with a **VACUUM**. In this case, the **VACUUM** is required even if the database is still uninitialized.

Auto-vacuum has some significant limitations. Although auto-vacuum is capable of releasing free pages, it does so by swapping them with active pages. This can lead to higher levels of fragmentation within the database. Unlike the traditional **VACUUM** command, auto-vacuum makes no attempt to defragment the database, nor does it repack records into the individual pages. This can lead to inefficient use of space and performance degradation.

Because of these limitations, it is recommended any database with a moderate transaction rate is occasionally vacuumed, even if auto-vacuum is enabled.

### See Also

[incremental\\_vacuum](#), [VACUUM](#) [SQL Cmd, Ap C]

---

## cache\_size

Set the size of the database page cache

### Common Usage

```
PRAGMA [database.]cache_size;
PRAGMA [database.]cache_size = pages;
```

## Description

The `cache_size` pragma can get or temporarily set the maximum size of the in-memory page cache. The *pages* value represents the number of pages in the cache. Normally, each attached database has an independent cache.

Adjustments made by the `cache_size` pragma only persist for the lifetime of the database connection. A common use of this pragma is to temporarily boost the cache size for I/O intensive operations. When building a new index on a large table, raising the cache size (sometimes as much as 100× or even 1,000× the default size) can often result in a considerable performance increase.

Care must be taken when using extremely large cache sizes, however. If the cache size is so large that the cache grows to exceed the available physical memory, the overall performance is likely to be much lower than simply using a smaller cache. The actual amount of memory used by the cache is determined by the size of the database pages (plus some overhead) and the cache size (in pages).

The built-in page cache has a default size of 2,000 pages and a minimum size of 10 pages. The full data cache is not allocated immediately, but grows on demand with the cache size acting as a limiter on that growth. If the cache size is made larger, the limit is simply raised. If the cache size is made smaller, the limit is lowered but the cache is not necessarily immediately flushed to recover the memory.

The built-in page cache requires some overhead. The exact size of the cache overhead depends on the platform, but it is in the neighborhood of 100 bytes. The maximum memory footprint for the cache can be approximated with the formula  $( \text{page\_size} + 128 ) * \text{cache\_size}$ .

## See Also

[default\\_cache\\_size](#), [page\\_size](#)

---

## case\_sensitive\_like

Control the case-sensitivity of the LIKE operator

### Common Usage

```
PRAGMA case_sensitive_like = switch;
```

### Description

The `case_sensitive_like` pragma controls the case-sensitivity of the built-in LIKE expression. By default, this pragma is false, indicating that the built-in LIKE operator ignores lettercase. This pragma applies to all databases attached to a database connection.

This is a write-only pragma. There is no way to query for the current state, other than issuing an SQL statement such as `SELECT 'A' NOT LIKE 'a'`; If `case_sensitive_like` is true, this statement will return 1.

This pragma only applies to the built-in version of LIKE. If the default behavior has been overridden by a user-defined `like()` SQL function, this pragma is ignored.

## See Also

[like\(\)](#) [SQL Func, Ap E], [LIKE](#) [SQL Expr, Ap D]

---

## collation\_list

List current collations

### Common Usage

```
PRAGMA collation_list;
```

### Description

The `collation_list` pragma lists all the active collations in the current database connection. This pragma will return a two-column table with one row per active collation.

Column name	Column type	Meaning
seq	Integer	Collation sequence number
name	Text	Name of collation

Unless an application has defined additional collations, the list will be limited to the built-in collations `NOCASE`, `RTRIM`, and `BINARY`.

### See Also

[database\\_list](#), [sqlite3\\_create\\_collation\(\)](#) [C API, Ap G]

---

## count\_changes

Enable change counts for INSERT, UPDATE, and DELETE

### Common Usage

```
PRAGMA count_changes;
PRAGMA count_changes = switch;
```

### Description

The `count_changes` pragma gets or sets the return value of data manipulation statements such as `INSERT`, `UPDATE`, and `DELETE`. By default, this pragma is false and these statements do not return anything. If set to true, each data manipulation statement will return a one-column, one-row table consisting of a single integer value. This value indicates how many rows were modified by the statement.

The values returned are very similar to those returned by the SQL function `changes()`, with one small difference. Rows that are modified by an `INSTEAD OF` trigger on a view will be counted within the statement return value, but will not be counted by `changes()`.

This pragma affects all statements processed by a given database connection.

### See Also

[changes\(\)](#) [SQL Func, Ap E], [sqlite3\\_changes\(\)](#) [C API, Ap G]

---

## database\_list

List currently attached databases

### Common Usage

```
PRAGMA database_list;
```



## Description

The `database_list` pragma lists all of the attached databases in this database connection. This pragma will return a three-column table with one row per open or attached database.

Column name	Column type	Meaning
<code>seq</code>	Integer	Database sequence number
<code>name</code>	Text	Logical database name
<code>file</code>	Text	Path and name of database file

Not all attached databases will have an associated file. In-memory databases and temporary databases only have an empty string in the file column.

## See Also

[ATTACH DATABASE](#) [SQL Cmd, Ap C]

## default\_cache\_size

Set default size of page cache for this database

### Common Usage

```
PRAGMA [database.]default_cache_size;
PRAGMA [database.]default_cache_size = pages;
```

## Description

The `default_cache_size` pragma controls default cache size for a given database. The *pages* value is stored in the database file, allowing this value to persist across database connections. The default cache size may be temporarily overridden using the `cache_size` pragma. Setting this value also sets the limit on the current page cache.

## See Also

[cache\\_size](#), [page\\_size](#)

## encoding

Control the default text encoding

### Common Usage

```
PRAGMA encoding;
PRAGMA encoding = format;
```

## Description

The `encoding` pragma controls how strings are encoded and stored in a database file. Any string value that is recorded to the database is first re-encoded into this format.

The *format* value can be one of 'UTF-8', 'UTF-16le', or 'UTF-16be'. Additionally, if the value 'UTF-16' is given, either 'UTF-16le' or 'UTF-16be' will be used, as determined by the native endian of the processor. Any version of SQLite running on any platform should be able to read a database file, regardless of the encoding.

## foreign\_keys

The encoding can only be set on the `main` database, and only before the database is initialized. All attached databases must have the same encoding as the `main` database. If `ATTACH` is used to create a new database, it will automatically inherit the encoding of the `main` database. If the `main` database has not been initialized when `ATTACH` is run, it will automatically be initialized with the current default values before the `ATTACH` command is allowed to run.

### See Also

[ATTACH DATABASE](#) [SQL Cmd, Ap C]

---

## foreign\_keys

Enable foreign key constraints

### Common Usage

```
PRAGMA foreign_keys;  
PRAGMA foreign_keys = switch;
```

### Description

The `foreign_keys` pragma controls the enforcement of foreign key constraints in all of the attached databases. If set to off, foreign key constraints are ignored. The default value is off.

For many years, SQLite would parse foreign key constraints, but was unable to enforce them. When native support for foreign key constraints was finally added to the SQLite core, enforcement was off by default to avoid any backwards compatibility issues.

This default value may change in future releases. To avoid problems, it is recommended that an application explicitly set the pragma one way or the other.

This pragma cannot be set when there is an active transaction in progress.

### See Also

[foreign\\_key\\_list](#)

---

## foreign\_key\_list

List all foreign keys in the given table

### Common Usage

```
PRAGMA [database.]foreign_key_list( table_name );
```

### Description

The `foreign_key_list` pragma lists all the foreign key references that are part of the specified table. That list will contain one row for each column of each foreign key contained within the table.

Column name	Column type	Meaning
<code>id</code>	Integer	Foreign key ID number
<code>seq</code>	Integer	Column sequence number for this key
<code>table</code>	Text	Name of foreign table
<code>from</code>	Text	Local column name

Column name	Column type	Meaning
to	Text	Foreign column name
on_update	Text	ON UPDATE action
on_delete	Text	ON DELETE action
match	Text	Always NONE

## See Also

[foreign\\_keys](#)

---

## freelist\_count

Return number of free pages in database file

### Common Usage

```
PRAGMA [database.]freelist_count;
```

### Description

The `freelist_count` pragma returns a single integer indicating how many database pages are currently marked as free and available (contain no valid data). These pages can be recovered by vacuuming the database.

## See Also

[auto\\_vacuum](#), [incremental\\_vacuum](#), [VACUUM](#) [SQL Cmd, Ap C]

---

## full\_column\_names

Control column-name format used in queries

### Common Usage

```
PRAGMA full_column_names;
PRAGMA full_column_names = switch;
```

### Description

The `full_column_names` pragma, in conjunction with the `short_column_names` pragma, controls how the database connection specifies and formats column names in result sets. If `full_column_name` is enabled, output column expressions that consist of a single named table column will be expanded to the full `table_name.column_name` format. It is off by default.

The general rules for output names are:

- If an output column has an `AS name` clause, `name` is used.
- If `short_column_names` is enabled and the output column is an unmodified source column, the result set column name is `column_name`.
- If `full_column_names` is enabled and the output column is an unmodified source column, the result set column name is `table_name.column_name`.
- The result set column name is the text of the column expression, as given.

fullfsync

If `full_column_names` and `short_column_names` are both enabled, `short_column_names` will override `full_column_names`.

Note that there is no guarantee the result set column names will remain consistent with future versions of SQLite. If your application depends on specific, recognizable column names, you should always use an `AS` clause.

### See Also

[short\\_column\\_names](#)

---

## fullfsync

Control the level of disk synchronization

### Common Usage

```
PRAGMA fullfsync;  
PRAGMA fullfsync = switch;
```

### Description

The `fullfsync` pragma enables the `F_FULLFSYNC` filesystem synchronization method. This provides an extra layer of robust file syncing. Currently, Mac OS X is the only operating system that supports this method.

### See Also

[synchronous](#)

---

## ignore\_check\_constraints

Disable CHECK constraints

### Common Usage

```
PRAGMA ignore_check_constraints;  
PRAGMA ignore_check_constraints = switch;
```

### Description

The `ignore_check_constraints` pragma controls the enforcement of `CHECK` constraints. `CHECK` constraints are defined in `CREATE TABLE` statements as arbitrary expressions that must be true before a row can be inserted or updated. If this pragma is set, this type of constraint is ignored. Turning this pragma back on will not verify existing rows.

*This is an undocumented pragma.*

---

## incremental\_vacuum

Activate an incremental vacuum

### Common Usage

```
PRAGMA [database.]incremental_vacuum( pages );
```

### Description

The `incremental_vacuum` pragma manually triggers a partial vacuum of a database file. If the database has auto-vacuum enabled and is in incremental mode, this pragma will attempt to

release up to *pages* file pages. This is done by migrating them to the end of the file and truncating the file. If *pages* is omitted, or has a value of zero or less, the entire free list will be released.

If the database does not have auto-vacuum enabled, or is not in incremental mode, this pragma has no effect.

### See Also

[auto\\_vacuum](#), [freelist\\_count](#), [VACUUM](#) [SQL Cmd, Ap C]

## index\_info

List table and columns contained in an index

### Common Usage

```
PRAGMA [database.]index_info( index_name );
```

### Description

The `index_info` pragma queries information about a database index. The result set will contain one row for each column contained in the index.

Column name	Column type	Meaning
seq	Integer	Column sequence number
cid	Integer	Column index within table
name	Text	Name of column

### See Also

[index\\_list](#), [table\\_info](#)

## index\_list

List all indexes associated with a table

### Common Usage

```
PRAGMA [database.]index_list( table_name );
```

### Description

The `index_list` pragma lists all of the indexes associated with a table. The result set will contain one row for each index.

Column name	Column type	Meaning
seq	Integer	Index sequence number
name	Text	Name of index
unique	Integer	Is UNIQUE index

### See Also

[index\\_info](#), [table\\_info](#)

---

## integrity\_check

Initiate a database file integrity verification

### Common Usage

```
PRAGMA [database.]integrity_check;  
PRAGMA [database.]integrity_chcek( max_errors );
```

### Description

The `integrity_check` pragma runs a self-check on the database structure. The check runs through a battery of tests that verify the integrity of the database file, its structure, and its contents. Errors are returned as text descriptions in a single-column table. At most, `max_errors` are reported before the integrity check aborts. By default, `max_errors` is 100.

If no errors are found, a single row consisting of the text value `ok` will be returned.

Unfortunately, if an error is found, there is typically very little that can be done to fix it. Although you may be able to extract some of the data, it is best to have regular dumps or backups.

### See Also

[quick\\_check](#)

---

## journal\_mode

Control the creation and cleanup of journal files

### Common Usage

```
PRAGMA journal_mode;  
PRAGMA journal_mode = mode;  
PRAGMA database.journal_mode;  
PRAGMA database.journal_mode = mode;
```

### Description

The `journal_mode` pragma gets or sets the journal mode. The journal mode controls how the journal file is stored and processed.

Journal files are used by SQLite to roll back transactions due to an explicit `ROLLBACK` command, or because an unrecoverable error was encountered (such as a constraint violation). Normally, a journal file is required to process any SQL command that causes a modification to a database file. The active lifetime of a journal file extends from the first database modification to the end of the commit process. Journal files are required for both auto-commit transactions (individual SQL commands) as well as explicit transactions. Journal files are a critical part of the transaction process.

There are five supported journal modes:

#### DELETE

This is the normal behavior. At the conclusion of a transaction, the journal file is deleted.

#### TRUNCATE

The journal file is truncated to a length of zero bytes. On many filesystems, this is slightly faster than a delete.

**PERSIST**

The journal file is left in place, but the header is overwritten to indicate the journal is no longer valid. On some filesystems, this can be faster still, as the file blocks remain allocated.

**MEMORY**

The journal record is held in memory, rather than on disk. This option is extremely fast, but also somewhat dangerous. If an application crashes or is killed while a transaction is in progress, it is likely to result in a corrupt database file.

**OFF**

No journal record is kept. As with the **MEMORY** journal mode, if the application crashes or is killed, the database will likely become corrupted. Further, if the journal is completely turned off, the database has no rollback capability. The **ROLLBACK** command should not be used on a database that has the journal turned off.

The behavior of the `journal_mode` pragma depends on whether an explicit database name is given or not. If no database name is given, the pragma gets or sets the default value stored in the database connection. This is the mode that will be used for any newly attached database, and will not modify database files that are already open.

Each open database also has its own unique journal mode. If a database name is given, this pragma will get or set the journal mode for that specific database. If you want to set the mode of the `main` database, you must explicitly use the `main` database name.

All versions of the `journal_mode` pragma will return the current value as a lowercase text value.

In-memory databases only support the **MEMORY** and **OFF** modes. Any attempt to set an in-memory database to a different mode will silently fail and the existing mode will be returned.

**See Also**

[journal\\_size\\_limit](#), [synchronous](#), [ROLLBACK TRANSACTION](#) [SQL Cmd, Ap C]

---

**journal\_size\_limit**

Set a maximum size for released journal files

**Common Usage**

```
PRAGMA [database.]journal_size_limit;
PRAGMA [database.]journal_size_limit = max_bytes;
```

**Description**

The `journal_size_limit` pragma forces the partial deletion of large journal files that would otherwise be left in place. Although journal files are normally deleted when a transaction completes, if a database is set to use persistent journal mode, the journal file is simply left in place. In some situations, the journal file can also remain if the database is set to use exclusive locking mode.

If a journal size limit has been set, SQLite will take the time to examine any journal file that would normally be left in place. If the journal file is larger than `max_bytes`, the file is truncated to `max_bytes`. This keeps very larger journal files (such as those left behind from a `VACUUM`) from continuing to consume excessive storage space.

## legacy\_file\_format

When first opened or attached, each database is assigned the compile-time default. This is normally -1, indicating that there is no limit. Each database in a database connection can be set to a different value. Databases must be set individually, even if they are all set to the same value.

Both the get and the set syntax will return the current limit.

### See Also

[journal\\_mode](#), [locking\\_mode](#)

---

## legacy\_file\_format

Determine the default format for new database files

### Common Usage

```
PRAGMA legacy_file_format;  
PRAGMA legacy_file_format = switch;
```

### Description

The `legacy_file_format` pragma gets or sets the legacy compatibility flag. This flag is used to determine what file format will be used when creating new database files. If the flag is set to true, SQLite will create new database files in a “legacy” file format that is backwards compatible all the way to SQLite v3.0.0. If the flag is not set, SQLite will create new files in the most up-to-date format supported by that library.

By default, this pragma is on, meaning databases will be created using the legacy format. Because the default is on, the vast majority of SQLite files out there are in the legacy file format.

This pragma cannot be used to determine the format of an existing file, nor can it be used to change an existing file. It only effects new files created with this database connection, and must be set before the database file is initialized. An existing legacy file can be promoted to the latest format by setting this pragma to off and manually vacuuming the file, but downgrades back to the legacy format are not supported.

The main difference between the original file format and the most current file format is support for descending indexes. Descending indexes cannot be used in conjunction with the legacy file format. The newer format also uses a more efficient on-disk representation for the integer values 0 and 1 (used for Boolean values) that saves one byte per value.

Please note that the use of this pragma does *not* guarantee backwards compatibility. If a database is created using the legacy file format, but the schema (`CREATE TABLE`, etc.) uses more modern SQL language features, you won't be able to open the database with an older version of SQLite.

When the latest file format (format v4) was first introduced, this flag had a default value of false. This caused a great number of problems in environments that did incremental or sporadic upgrades. To avoid such problems, the default value was changed to true. It is conceivable that the default value for this pragma may change in the future. The v4 file format is backward compatible to SQLite version 3.3.0.

### See Also

[VACUUM](#) [SQL Cmd, Ap C], [CREATE INDEX](#) [SQL Cmd, Ap C]



---

## locking\_mode

Control how a database releases read/write locks

### Common Usage

```
PRAGMA locking_mode;  
PRAGMA locking_mode = mode;  
PRAGMA database.locking_mode;  
PRAGMA database.locking_mode = mode;
```

### Description

The `locking_mode` pragma controls how database file locks are managed. The mode can either be `NORMAL` or `EXCLUSIVE`. In normal mode, the database connection acquires and releases the appropriate locks with each transaction. In exclusive mode, the locks are acquired in the normal fashion, but are not released when a transaction finishes.

Although exclusive locking mode prevents any other database connections from accessing the database, it also provides better performance. This may be an easy trade-off in situations such as some embedded environments, where it is very unlikely that multiple processes will ever attempt to access the same database.

Exclusive locking reduces the start-up cost of a transaction by eliminating the need to acquire the appropriate locks. It also allows SQLite to skip several file reads at the start of each transaction. For example, when SQLite starts a new transaction, it will normally reread the database header to verify that the database schema has not changed. This is not required if the database is in exclusive mode.

Since temporary and in-memory databases cannot be accessed by more than one database connection, they are always in exclusive mode. Any attempt to set these database types to normal mode will silently fail.

The behavior of the `locking_mode` pragma depends on if an explicit database is given or not. If no database name is given, the pragma gets or sets the default value stored in the database connection. This is the mode that will be used for any newly attached database. Each open database also has its own unique journal mode. If a database name is given, this pragma will get or set the journal mode for that specific database. If you want to get or set the mode of the `main` database, you must explicitly use the `main` database name.

There are two ways to release the locks of a database in exclusive mode. First, the database can simply be closed (or detached). This will release any locks. The database can be reopened (or reattached). Even if the default locking mode is exclusive, the locks will not be acquired until the database goes through a transaction cycle.

The second way to release the locks is to place the database into normal locked mode *and* execute some SQL command that will force a lock/unlock transaction cycle. Simply putting the database into normal mode will not release any locks that have already been acquired.

### See Also

[journal\\_mode](#), [lock\\_status](#), [ATTACH DATABASE](#) [SQL Cmd, Ap C], [DETACH DATABASE](#) [SQL Cmd, Ap C]

---

## lock\_proxy\_file

Set the proxy locking directory

### Common Usage

```
PRAGMA lock_proxy_file;
PRAGMA lock_proxy_file = ':auto:';
PRAGMA lock_proxy_file = 'file_path';
```

### Description

The `lock_proxy_file` pragma gets or sets the file used for proxy locks. The value `:auto:` will set it back to the automatic default. The proxy locking system is only available on Mac OS X, and only applies to databases residing on Apple Filing Protocol shares.

*This is an undocumented pragma.*

---

## lock\_status

Display lock state of each database

### Common Usage

```
PRAGMA lock_status;
```

### Description

The `lock_status` pragma lists all of the databases in a connection and their current lock status. The result set will contain one row for each attached database.

Column name	Column type	Meaning
database	Text	Database name
status	Text	Lock status

The following locking states may be indicated:

Value	Meaning
unlocked	Database has no locks
shared	Database has a shared read lock
reserved	Database has the reserved write-enable lock
pending	Database has the pending write-enable lock
exclusive	Database has the exclusive write lock
closed	Database file is not open
unknown	Lock state is not known

The first five states correspond to the standard locks SQLite uses to maintain read and write transactions. The `closed` value is normally returned when a brand new database file has been created, but it has not yet been initialized. Since the locking is done through the filesystem, any database that does not have an associated file will return `unknown`. This includes both in-memory databases, as well as some temporary databases.

SQLite must be compiled with the `SQLITE_DEBUG` directive for this pragma to be included.

*This is an undocumented pragma.*

### See Also

[schema\\_version](#), [journal\\_mode](#), [journal\\_size\\_limit](#), [ATTACH DATABASE](#) [SQL Cmd, Ap C], [DETACH DATABASE](#) [SQL Cmd, Ap C]

---

## max\_page\_count

Limit the size of a database

### Common Usage

```
PRAGMA [database.]max_page_count;
PRAGMA [database.]max_page_count = max_page;
```

### Description

The `max_page_count` pragma gets or sets the maximum allowed page count for a database. This value is database specific, but is stored as part of the database connection and must be reset every time the database is opened.

If a database attempts to grow past the maximum allowed page count, an out-of-space error will be returned, similar to when a filesystem runs out of space.

Both versions of this command return the current value. If you attempt to set the value lower than the current page count, no change will be made (and the old value will be returned).

The default value is 1,073,741,823 ( $2^{30} - 1$ , or one giga-page). When used in conjunction with the default 1 KB page size, this allows databases to grow up to one terabyte. There is no way to restore the default value, other than to manually set the same value (or close and reopen the database). The `max_page` value is limited to a 32-bit signed value.

### See Also

[page\\_count](#), [page\\_size](#)

---

## omit\_readlock

Disable read locks on read-only files

### Common Usage

```
PRAGMA omit_readlock;
PRAGMA omit_readlock = switch;
```

### Description

The `omit_readlock` pragma disables read locks when accessing a read-only file. Disabling read locks will provide better performance, but can only be done safely when *all* processes access the file as read-only.

This flag is particularly useful when accessing database files on read-only media, such as an optical disc. It can also be safely used for “reference” database files, such as dictionary files, that are distributed but never modified by the client software.

page\_count

Disabling read locks for all read-only files is not recommended. If one process opens a database read-only and another process opens the same database read/write, the locking system is still required for transactions to work properly. This pragma should only be considered in situations where every possible process that might access a database file is doing so in a read-only fashion.

*This is an undocumented pragma.*

---

## page\_count

Return total number of pages in a database

### Common Usage

```
PRAGMA [database.]page_count;
```

### Description

The `page_count` pragma returns the current number of pages in *database*. The page count includes all pages in the file, including free pages. The size of the database file should be `page_count * page_size`.

### See Also

[max\\_page\\_count](#), [page\\_size](#), [cache\\_size](#), [freelist\\_count](#)

---

## page\_size

Set the size of a database page

### Common Usage

```
PRAGMA [database.]page_size;  
PRAGMA [database.]page_size = bytes;
```

### Description

The `page_size` pragma gets or sets the size of the database pages. The *bytes* size must be a power of two. By default, the allowed sizes are 512, 1024, 2048, 4096, 8192, 16384, and 32768 bytes. This value becomes fixed once the database is initialized. The only way to alter the page size on an existing database is to set the page size and then immediately `VACUUM` the database.

The default page size is calculated from a number of factors. The default page size starts at 1024 bytes. If the datatype driver indicates that the native I/O block of the filesystem is larger, that larger value will be used up to the maximum default size, which is normally set to 8192. These values can be altered with the `SQLITE_DEFAULT_PAGE_SIZE`, `SQLITE_MAX_DEFAULT_PAGE_SIZE`, and `SQLITE_MAX_PAGE_SIZE` compiler-time directives.

The end result is that the page size for file-based databases will typically be between 1 KB and 4 KB on Microsoft Windows, and 1 KB on most other systems, including Mac OS X, Linux, and other Unix systems.

### See Also

[cache\\_size](#)

---

## parser\_trace

Enable parser debug information

### Common Usage

```
PRAGMA parser_trace = switch;
```

### Description

The `parser_trace` pragma enables SQL parser debugging. When enabled, the SQL parser will print its state as it parses SQL commands. SQLite must be compiled with the `SQLITE_DEBUG` directive for parser trace functionality to be included.

### See Also

[sql\\_trace](#), [vdbe\\_trace](#), [vdbe\\_listing](#)

---

## quick\_check

Initiate a partial database file integrity verification

### Common Usage

```
PRAGMA [database.]quick_check;  
PRAGMA [database.]quick_check( max_errors );
```

### Description

The `quick_check` pragma runs an abbreviated integrity check on a database file. The `quick_check` pragma is identical to the `integrity_check` pragma, except that it does not verify that the contents of each index is in sync with its source-table data. By skipping this test, the time required to do the integrity test is greatly reduced.

### See Also

[integrity\\_check](#)

---

## read\_uncommitted

Enable reads of uncommitted data from database cache

### Common Usage

```
PRAGMA read_uncommitted;  
PRAGMA read_uncommitted = switch;
```

### Description

The `read_uncommitted` pragma gets or sets the shared cache isolation method.

If the same process opens the same database multiple times, SQLite can be configured to allow those connections to share a single cache instance. This is helpful in very low-memory situations, such as low-cost embedded systems.

This pragma controls which locks are required to access the shared cache. Setting this pragma relaxes some of the locking requirements and allows connections to read from the cache, even if another connection is in the middle of a transaction. This allows better concurrency, but it also means that readers may see data the writer has not committed, breaking transaction isolation.

The `read_uncommitted` pragma is only applicable to systems that use shared cache mode, which is normally not used on desktop systems. If you are using shared cache mode and may have a need for this pragma, please see the source code and online documentation at <http://www.sqlite.org/sharedcache.html> for more information.

---

## recursive\_triggers

Enable recursive trigger calls

### Common Usage

```
PRAGMA recursive_triggers;  
PRAGMA recursive_triggers = switch;
```

### Description

The `recursive_triggers` pragma gets or sets the recursive trigger functionality. If recursive triggers are not enabled, a trigger action will not fire another trigger.

For many years, SQLite did not support recursive triggers. When they were added, the default for this pragma was set to off, in an effort to keep the default settings backwards compatible. The default version of this pragma may change in a future version of SQLite.

### See Also

[foreign\\_keys](#)

---

## reverse\_unordered\_selects

Reverse the order of unsorted query results

### Common Usage

```
PRAGMA reverse_unordered_selects;  
PRAGMA reverse_unordered_selects = switch;
```

### Description

The `reverse_unordered_selects` pragma gets or sets the reverse select flag. If this flag is set, SQLite will reverse the natural ordering of `SELECT` statements that do not have an explicit `ORDER BY` clause.

SQLite, as well as the SQL standard, makes no promises about the ordering of `SELECT` results that do not have an explicit `ORDER BY` clause. Changes in the database (such as adding an index), or changes in the query optimizer can cause SQLite to return rows in a different order.

Unfortunately, writing application code that is dependent on the results order is a common mistake. This pragma can be used to help find and fix those types of bugs by altering the default output order. This can be especially effective if it is turned on or off randomly before each query.

---

## schema\_version

Database schema change control

### Common Usage

```
PRAGMA [database.]schema_version;  
PRAGMA [database.]schema_version = number;
```

### Description

The `schema_version` pragma gets or sets the schema version value that is stored in the database header. This is a 32-bit signed integer value that keeps track of schema changes. Whenever a schema-altering command is executed (for example, `CREATE...` or `DROP...`), this value is incremented.

This value is used internally by SQLite to keep a number of different caches consistent, as well as keep prepared statements consistent with current database format. Manually altering this value can result in a corrupt database.

### See Also

[user\\_version](#)

---

## secure\_delete

Overwrite deleted content with zeros

### Common Usage

```
PRAGMA secure_delete;  
PRAGMA secure_delete = switch;  
PRAGMA database.secure_delete;  
PRAGMA database.secure_delete = switch;
```

### Description

The `secure_delete` pragma is used to control how content is deleted from the database. Normally, deleted content is simply marked as unused. If the `secure_delete` flag is on, deleted content is first overwritten with a series of 0 byte values, removing the deleted values from the database file. The default value for the secure delete flag is normally off, but this can be changed with the `SQLITE_SECURE_DELETE` build option.

If a database name is given, the flag will be get or set for just that database. If no database name is given, setting the value will set it for all attached databases, while getting the value will return the current value for the `main` database. Newly attached databases will take on the same value as the `main` database.

Be aware that SQLite cannot securely delete information from the underlying storage device. If the write operation causes the filesystem to allocate a new device-level block, the old data may still exist on the raw device. There is also a slight performance penalty associated with this directive.

short\_column\_names

The `secure_delete` flag is stored in the page cache. If shared cache mode is enabled, changing this flag on one database connection will cause the flag to be changed for all database connections sharing that cache instance.

## See Also

[SQLITE\\_SECURE\\_DELETE](#)

---

## short\_column\_names

Control column-name format used in queries

### Common Usage

```
PRAGMA short_column_names;  
PRAGMA short_column_names = switch;
```

### Description

The `short_column_names` pragma, in conjunction with the `full_column_names` pragma, controls how the database connection specifies and formats column names in result sets. If `short_column_name` is enabled, output column expressions that consist of a single named table column will be clipped to only include the column name. This pragma is on by default.

The general rules for output names are:

- If an output column has an `AS name` clause, `name` is used.
- If `short_column_names` is enabled and the output column is an unmodified source column, the result set column name is `column_name`.
- If `full_column_names` is enabled and the output column is an unmodified source column, the result set column name is `table_name.column_name`.
- The result set column name is the text of the column expression, as given.

If `full_column_names` and `short_column_names` are both enabled, `short_column_names` will override `full_column_names`.

Note that there is no guarantee the result set column names will remain consistent with future versions of SQLite. If your application depends on specific, recognizable column names, you should use an `AS` clause.

## See Also

[full\\_column\\_names](#)

---

## sql\_trace

Dump SQL trace data

### Common Usage

```
PRAGMA sql_trace;  
PRAGMA sql_trace = switch;
```



## Description

The `sql_trace` pragma dumps SQL trace results to the screen. When enabled, trace data normally passed to the `sqlite3_trace()` callback will be printed. SQLite must be compiled with the `SQLITE_DEBUG` directive for this pragma to be included.

*This is an undocumented pragma.*

## See Also

[vdbe\\_trace](#), [parser\\_trace](#), [vdbe\\_listing](#)

---

## synchronous

Control the database disk synchronization

### Common Usage

```
PRAGMA [database.]synchronous;
PRAGMA [database.]synchronous = mode;
```

## Description

The `synchronous` pragma gets or sets the current disk synchronization mode. This controls how aggressively SQLite will write data all the way out to physical storage.

Because most physical storage systems (such as hard drives) are very slow when compared to processor and memory speeds, most computing environments have a large number of caches and buffers between an application and the actual, long-term physical storage system. These layers introduce a significant window of time between the time when an application is told the data was successfully written, and the time when the data is actually written to long-term storage. Three or four seconds is typical, but in some cases this window can be a dozen seconds or more. If the system crashes or suffers a power failure within that window, some of the “written” data will be lost.

If that were to happen to an SQLite database file, the database would undoubtedly become corrupted. To properly enforce transactions and prevent corruption, SQLite depends on writes being permanent, even in the face of a system crash or power failure. This requires that SQLite write commands happen in order and go all the way to the physical storage. To accomplish this, SQLite will request an immediate disk synchronization after any critical write operations. This causes the application to pause until the operating system can confirm that the data has been written to long-term storage.

While this is very safe, it is also very slow. In some situations, it may be acceptable to turn off some of these protections in favor of raw speed. While this isn’t recommended for long-term situations, it can make sense for short, repeatable operations, such as bulk-loading import data. Just be sure to make a backup first.

SQLite offers three levels of protection, as shown in the following table:

Mode	Meaning
0 or OFF	No syncs at all
1 or NORMAL	Sync after each sequence of critical disk operations
2 or FULL	Sync after each critical disk operation

## table\_info

The set mode can be either the name or the integer equivalent. The returned value will always be an integer.

In **FULL** mode, a full synchronization is done after each and every critical disk operation. This mode is designed to avoid corruption in the face of any application crash, system crash, or power failure. It is the safest, but also the slowest. The default mode is **FULL** (not **NORMAL**).

In **NORMAL** mode, a full synchronization is done after each sequence of critical disk operations. This mode reduces the total number of synchronization calls, but introduces a very small chance of having a system crash or power failure corrupt the database file. **NORMAL** mode attempts to strike a balance between good protection and moderate performance.

In **OFF** mode, no attempt is made to flush or synchronize writes, leaving it up to the operating system to write out any filesystem cache at its own convenience. This mode is much, much faster than the other two modes, but leaves SQLite wide open to system crashes and power failures, even after a transaction has completed.

Be aware that on some systems, a power failure can still cause database corruption, even if running in **FULL** mode. There are a number of disk controllers that will falsely report a synchronization request as successfully completed before all of the data is actually written to nonvolatile storage. If a power failure happens while data is still being held in the disk controller cache, a file corruption may still occur. Unfortunately, there isn't anything SQLite or the host operating system can do about this, as there is no way for the operating system or SQLite to know the information is untrue.

### See Also

[journal\\_mode](#), [fullfsync](#)

---

## table\_info

List column information for a table

### Common Usage

```
PRAGMA [database.]table_info( table_name );
```

### Description

The `table_info` pragma is used to query information about a specific table. The result set will contain one row for each column in the table.

Column name	Column type	Meaning
cid	Integer	Column index
name	Text	Column name
type	Text	Column type, as given
notnull	Integer	Has a NOT NULL constraint
dflt_value	Text	DEFAULT value
pk	Integer	Is part of the PRIMARY KEY

The default value (`dflt_value`) will be given as a text representation of the literal value representation. For example, a default text value includes the single quotes.

## See Also

[index\\_list](#)

---

## temp\_store

Control the temporary storage mode

### Common Usage

```
PRAGMA temp_store;
PRAGMA temp_store = mode;
```

### Description

The `temp_store` pragma gets or sets the storage mode used by temporary database files. This pragma does not affect journal files.

SQLite supports the following storage modes:

Mode	Meaning
0 or DEFAULT	Use compile-time default. Normally FILE.
1 or FILE	Use file-based storage
2 or MEMORY	Use memory-based storage

The set mode can be either the name or the integer equivalent. The returned value will always be an integer.

Memory-based storage will make temporary databases equivalent to in-memory databases. File-based databases will initially be in-memory databases, until they outgrow the page cache. This means that many “file-based” temporary databases never actually make it into a file.

Changing the mode will cause all temporary databases (and the data they contain) to be deleted.

In some cases, this pragma can be disabled with the `SQLITE_TEMP_STORE` compile-time directive. Possible compile-time values include:

Value	Meaning
0	Always use files, ignore pragma
1	Allow pragma, default to files
2	Allow pragma, default to memory
3	Always use memory, ignore pragma

`temp_store_directory`

The default value is 1. Temporary storage defaults to using files, but allows the `temp_store` pragma to override that choice.

### See Also

[temp\\_store\\_directory](#), [journal\\_mode](#)

---

## temp\_store\_directory

Control the temporary file storage location

### Common Usage

```
PRAGMA temp_store_directory;  
PRAGMA temp_store_directory = 'directory_path';
```

### Description

The `temp_store_directory` pragma gets or sets the location used for temporary database files. This pragma does not change the location of journal files. If the specified location is not found or is not writable, an error is generated.

To revert the directory to its default value, set *directory\_path* to a zero-length string. The default value (as well as the interpretation of this value) is OS dependent.

Changing this pragma will cause all temporary databases (and the data they contain) to be deleted. Setting this pragma is not thread-safe. Ideally, this pragma should only be set as soon as the main database is opened.

Many temporary databases are never actually created on the filesystem, even if they're set to use a file for storage. Those files that are created are typically opened and then immediately deleted. Opening and deleting a file keeps the file active in the filesystem, but removes it from the directory listing. This prevents other processes from seeing or accessing the file, and guarantees the file will be fully deleted, even if the application crashes.

### See Also

[temp\\_store](#)

---

## user\_version

Control user-defined versioning

### Common Usage

```
PRAGMA [database.]user_version;  
PRAGMA [database.]user_version = number;
```

### Description

The `user_version` pragma gets or sets the user-defined version value that is stored in the database header. This is a 32-bit signed integer value that may be used for whatever purpose the developer sees fit. The value is not used by SQLite in any way.

### See Also

[schema\\_version](#)

---

## vdbe\_trace

Enable VDBE debug information

### Common Usage

```
PRAGMA vdbe_trace;  
PRAGMA vdbe_trace = switch;
```

### Description

The `vdbe_trace` pragma enables virtual database engine (VDBE) debugging. When enabled, each VDBE instruction is printed just prior to execution. SQLite must be compiled with the `SQLITE_DEBUG` directive for the VDBE trace functionality to be included.

See the online VDBE documentation (<http://www.sqlite.org/vdbe.html>) for more details.

### See Also

[vdbe\\_listing](#), [sql\\_trace](#), [parser\\_trace](#)

---

## vdbe\_listing

Cause the VDBE to dump each program before executing

### Common Usage

```
PRAGMA vdbe_listing;  
PRAGMA vdbe_listing = switch;
```

### Description

The `vdbe_listing` pragma enables VDBE debugging. When enabled, each VDBE program is printed just prior to execution. SQLite must be compiled with the `SQLITE_DEBUG` directive for the VDBE list functionality to be included.

See the online VDBE documentation (<http://www.sqlite.org/vdbe.html>) for more details.

### See Also

[vdbe\\_trace](#), [sql\\_trace](#), [parser\\_trace](#)

---

## writable\_schema

Allow modification of system tables

### Common Usage

```
PRAGMA writable_schema;  
PRAGMA writable_schema = switch;
```

### Description

The `writable_schema` pragma gets or sets the ability to modify system tables. If `writable_schema` is set, tables that start with `sqlite_` can be created and modified, including the `sqlite_master` table.

This pragma makes it possible to corrupt a database using only SQL commands. Be extremely careful when using this pragma.

*This is an undocumented pragma.*



---

# SQLite C API Reference

This appendix covers the data structures and functions that make up the C programming API. The appendix is designed to act as a reference, providing specific details about each function and data structure. It does not, however, provide a high-level overview of how all the parts fit together into a useful application. To understand the ideas and patterns behind the API, it is strongly recommended you review the material in [Chapter 7](#).

Those items marked **[EXP]** should be considered experimental. This is not meant to imply that those functions and features are risky or untested, simply that they are newer, and there is some chance the interface may change slightly in a future version of SQLite. This is somewhat rare, but it does happen. Those functions not marked experimental are more or less set in stone. The behavior of a function may change, if it is found to have a minor bug, but the interface definition will not. The SQLite team has a very strong belief in backwards compatibility and will not change the behavior of an existing interface if there is any chance it might break existing applications. New features that require changes result in new interfaces, such as the `_v2` version of some functions (for example, `sqlite3_open_v2()`). Generally, this makes upgrading the SQLite library used with an existing library a low-risk process.

The official documentation for the complete C programming interface can be found at <http://www.sqlite.org/c3ref/intro.html>.

## API Datatypes

This is a partial list of C datatypes used by the SQLite API. All of the common datatypes are listed. Those that have been omitted are extremely specialized, and are only used when implementing low-level extensions. For a complete list and more information, see <http://www.sqlite.org/c3ref/objlist.html> or the SQLite header files.

### sqlite3

A database connection

#### Description

The `sqlite3` structure represents a database connection to one or more database files. The structure is created with a call to `sqlite3_open()` or `sqlite3_open_v2()` and destroyed with `sqlite3_close()`. Nearly all data management operations must be done in the context of an `sqlite3` instance.

The `sqlite3` structure is opaque, and an application should never access any of the data fields directly.

#### See Also

[sqlite3\\_open\(\)](#), [sqlite3\\_open\\_v2\(\)](#), [sqlite3\\_close\(\)](#)

### sqlite3\_backup

An online backup context [EXP]

#### Description

The `sqlite3_backup` structure performs an online backup. This is done by making a low-level, page-by-page copy of the database image. The structure is created with a call to `sqlite3_backup_init()` and destroyed with `sqlite3_backup_finish()`.

The `sqlite3_backup` structure is opaque, and an application should never access any of the data fields directly.

#### See Also

[sqlite3\\_backup\\_init\(\)](#), [sqlite3\\_backup\\_finish\(\)](#)

### sqlite3\_blob

Incremental BLOB I/O

#### Description

The `sqlite3_blob` structure performs incremental I/O on a BLOB value. This allows an application to read and write BLOB values that are too large to fit in memory. The structure is created with `sqlite3_blob_open()` and destroyed with `sqlite3_blob_close()`.



The `sqlite3_blob` structure is opaque, and an application should never access any of the data fields directly.

### See Also

[sqlite3\\_blob\\_open\(\)](#), [sqlite3\\_blob\\_close\(\)](#)

## sqlite3\_context

SQL function context

### Description

The `sqlite3_context` structure acts as a data container to pass information between the SQLite library and a custom SQL function implementation. The structure is created by the SQLite library and passed into the function callbacks registered with `sqlite3_create_function()`. The callback functions can extract the database connection or user-data pointer from the context. The context is also used to pass back an SQL result value or error condition.

An application should never create or destroy an `sqlite3_context` structure.

The `sqlite3_context` structure is opaque, and an application should never access any of the data fields directly.

### See Also

[sqlite3\\_create\\_function\(\)](#)

## sqlite3\_int64, sqlite3\_uint64, sqlite\_int64, sqlite\_uint64

64-bit integer values

### Description

Platform-, processor-, and compiler-independent 64-bit integer types.

## sqlite3\_module

Virtual table implementation [EXP]

### Description

The `sqlite3_module` structure defines a virtual table. The structure contains a number of function pointers that taken together provide the implementation for a virtual table. The code for a virtual table extension typically allocates a static `sqlite3_module` structure. This structure is initialized with all the proper function pointers, contained within the module, and then passed into `sqlite3_create_module()`.

### See Also

[sqlite3\\_create\\_module\(\)](#)

---

## sqlite3\_mutex

A mutual exclusion lock

### Description

The `sqlite3_mutex` structure provides an abstract mutual exclusion lock. An application can create its own locks using the `sqlite3_mutex_alloc()` call, but it is much more common to reference the lock used by the database connection. This lock can be retrieved with the `sqlite3_db_mutex()` call. Mutex locks are locked and unlocked using the `sqlite3_mutex_enter()` and `sqlite3_mutex_leave()` calls.

The `sqlite3_mutex` structure is opaque, and an application should never access any of the data fields directly.

### See Also

[sqlite3\\_db\\_mutex\(\)](#), [sqlite3\\_mutex\\_alloc\(\)](#)

---

## sqlite3\_stmt

A prepared statement

### Description

The `sqlite3_stmt` structure holds a prepared statement. This is all the state and execution information required to build and execute an SQL statement. Statements are used to set any bound parameter values and get any result values. Statements are created with `sqlite3_prepare_xxx()` and destroyed with `sqlite3_finalize()`. Statements are always associated with a specific database connection.

The `sqlite3_stmt` structure is opaque, and an application should never access any of the data fields directly.

### See Also

[sqlite3\\_prepare\\_xxx\(\)](#), [sqlite3\\_finalize\(\)](#)

---

## sqlite3\_value

A database value

### Description

The `sqlite3_value` structure holds a database value. The structure contains the value as well as the type information. A value might hold an integer or floating-point number, a BLOB, a text value in one of many different UTF encodings, or a NULL. Values are used as the parameters to SQL function implementations. They can also be extracted from statement results.

Value structures come in two types: *protected* and *unprotected*. Protected values can safely undergo standalone type conversion, while unprotected values cannot. SQL function parameters are protected, and can be passed to any form of `sqlite3_value_xxx()`. Values extracted from `sqlite3_column_value()` are not unprotected. They can safely be passed to `sqlite3_bind_value()` or `sqlite3_result_value()`, but they cannot be passed to `sqlite3_value_xxx()`. To extract a native C datatype from a statement, use one of the other `sqlite3_column_xxx()` functions.

The `sqlite3_value` structure is opaque, and an application should never access any of the data fields directly.

### See Also

[sqlite3\\_column\\_xxx\(\)](#), [sqlite3\\_bind\\_xxx\(\)](#), [sqlite3\\_value\\_xxx\(\)](#), [sqlite3\\_result\\_xxx\(\)](#)

## sqlite3\_vfs

A virtual file system implementation

### Description

The `sqlite3_vfs` structure consists of a series of function pointers that make up a Virtual File System (VFS) module. A VFS implementation typically allocates an `sqlite3_vfs` structure, initializes the various fields, and passes the structure into `sqlite3_vfs_register()`.

### See Also

[sqlite3\\_vfs\\_register\(\)](#)

## API Functions

This is a list of nearly every supported function call in the SQLite API. The only functions that have been omitted are those related to internal developer testing and those functions that are considered obsolete.

Many of the functions return an SQLite result code. The topic of result codes is somewhat complex and has a lot of history. For a full discussion, see [“Result Codes and Error Codes” on page 146](#). The basics are pretty easy, however. Nearly every function returns `SQLITE_OK` if the function succeeded. Most other result codes indicate some type of error, but not all of them. For example, the codes `SQLITE_ROW` and `SQLITE_DONE` are used to indicate a specific program state. A result of `SQLITE_MISUSE` means that the application is using the API incorrectly. This is usually caused by the developer misunderstanding how the API works, or because of a program flow or logic error that causes an unintended call sequence.

## sqlite3\_aggregate\_context()

Allocate or retrieve aggregate state memory

### Definition

```
void* sqlite3_aggregate_context( sqlite3_context* ctx, int size );
```

`ctx`

An SQL function context, provided by the SQLite library.

`size`

The memory allocation size, in bytes.

### Returns

A pointer to the aggregate memory allocation.

sqlite3\_auto\_extension()

## Description

This function is used by an aggregate function implementation to allocate and retrieve a memory block. The first time it is called, a memory block of the requested size is allocated, all the bytes are set to zero, and the pointer is returned. Subsequent calls for the same function context will return the same block of memory. SQLite will automatically deallocate the memory after the aggregate finalize function is called.

This function is typically used to allocate and retrieve memory used to hold all the state information required to calculate an aggregate result. If the data structure needs to be initialized, a flag value is typically used. When the memory is first allocated, the flag will be set to zero (like the rest of the structure). On the first call, the structure can be initialized and the flag set to a nonzero value. Both the aggregate step and the finalize functions need to be prepared to initialize the memory.

## See Also

[sqlite3\\_create\\_function\(\)](#)

---

## sqlite3\_auto\_extension()

Register an automatic extension

### Definition

```
int sqlite3_auto_extension( entry_point );
```

```
void entry_point( );
```

*entry\_point*

A function pointer to an extension entry point.

*Returns*

An SQLite result code.

### Description

This function registers an extension entry-point function. Once an entry point is registered, any database connection opened by the SQLite library will automatically call the entry point. Multiple entry points can be registered. It is safe to register the same entry point multiple times. In that case, the entry point will only be called once.

Although the entry point is given as `void entry_point( )`, the actual format of an entry-point function is:

```
int entry_point( sqlite3* db, char** error, const sqlite3_api_routines* api );
```

The discrepancy of the types will likely require a cast or redefinition of the entry-point function.

This function can only be used to register extensions with static entry points. Dynamically loaded extensions cannot be directly registered with this function. To clear the list of automatic extensions, call `sqlite3_reset_auto_extension()`. This should be done before calling `sqlite3_shutdown()`.

For more information on extensions and entry points, see the section “[SQLite Extensions](#)” on page 204.

### See Also

[sqlite3\\_reset\\_auto\\_extension\(\)](#)

## sqlite3\_backup\_finish()

Complete an online backup [EXP]

### Definition

```
int sqlite3_backup_finish( sqlite3_backup* backup );
```

#### backup

An online backup handle.

#### Returns

An SQLite result code. A value of `SQLITE_OK` will be returned even if the backup was not completed.

### Description

This function releases an online backup handle. The backup handle will be released without error, even if `sqlite3_backup_step()` never returned `SQLITE_DONE`.

### See Also

[sqlite3\\_backup\\_init\(\)](#)

## sqlite3\_backup\_init()

Start an online backup [EXP]

### Definition

```
sqlite3_backup* sqlite3_backup_init(
    sqlite3* db_dst, const char* db_name_dst,
    sqlite3* db_src, const char* db_name_src );
```

#### db\_dst

The destination database connection.

#### db\_name\_dst

The destination logical database name in UTF-8. This can be `main`, `temp`, or the name given to `ATTACH DATABASE`.

#### db\_src

The source database connection. Must be different from `db_dst`.

#### db\_name\_src

The source logical database name in UTF-8.

#### Returns

An online backup handle.

sqlite3\_backup\_pagecount()

## Description

This function initiates an online database backup. The online backup APIs can be used to make a low-level copy of a complete database instance without locking the database. The backup APIs can be used to perform live backups, or they can be used to copy a file-backed database to an in-memory database (or vice-versa).

The application requires exclusive access to the destination database for the duration of the operation. The source database requires read-only access, but the locks are periodically released to allow other processes to continue to access and modify the source database.

To perform an online backup, a backup handle is created with `sqlite3_backup_init()`. The application continues to call `sqlite3_backup_step()` to transfer data, generally pausing for a short time between calls. Finally, `sqlite3_backup_finish()` is called to release the backup handle.

For more information on using the online backup APIs, see <http://www.sqlite.org/backup.html>.

## See Also

[sqlite3\\_backup\\_finish\(\)](#), [sqlite3\\_backup\\_step\(\)](#)

---

## sqlite3\_backup\_pagecount()

Get the number of pages in the source database [EXP]

### Definition

```
int sqlite3_backup_pagecount( sqlite3_backup* backup );
```

backup

An online backup handle.

Returns

The number of pages in the source database.

### Description

This function gets the total number of pages in the source database. This value is updated when `sqlite3_backup_step()` is called, and might not reflect recent activity on the source database.

## See Also

[sqlite3\\_backup\\_remaining\(\)](#), [sqlite3\\_backup\\_step\(\)](#)

---

## sqlite3\_backup\_remaining()

Get the number of pages remaining in a backup [EXP]

### Definition

```
int sqlite3_backup_remaining( sqlite3_backup* backup );
```

backup

An online backup handle.

*Returns*

The number of pages remaining in the backup process.

**Description**

This function is used to get the number of pages that still need to be backed up. This value is updated when `sqlite3_backup_step()` is called and may not reflect recent activity on the source database.

**See Also**

[sqlite3\\_backup\\_pagecount\(\)](#), [sqlite3\\_backup\\_step\(\)](#)

---

**sqlite3\_backup\_step()**

Continue an online backup [EXP]

**Definition**

```
int sqlite3_backup_step( sqlite3_backup* backup, int pages );
```

**backup**

An online backup handle.

**pages**

The number of pages to copy. If this value is negative, all remaining pages are copied.

*Returns*

An SQLite result code. `SQLITE_OK` indicates the pages were successfully copied, but more pages remain. `SQLITE_DONE` indicates that a complete backup was made. If `sqlite3_backup_step()` returns `SQLITE_BUSY` or `SQLITE_LOCKED`, the function can be safely retried at a later time.

**Description**

This function attempts to copy the specified number of pages from the source database to the destination database. A shared read lock is obtained and then released on the source database for each call to `sqlite3_backup_step()`. Larger page counts finish the backup more quickly, while smaller page counts allow more concurrent access.

Modifications made to the source database through the same database connection that is being used for the backup are automatically reflected into the destination database, allowing the online backup to continue.

Modifications made to the source database through any other database connection will cause the backup to reset and start over. This is transparent. If an application is attempting to back up a highly dynamic database it should call `sqlite3_backup_step()` very frequently and use a very large page count, or it risks continual reset. This could result in the backup perpetually failing to complete.

**See Also**

[sqlite3\\_backup\\_init\(\)](#)

---

**sqlite3\_bind\_XXX()**

Bind values to statement parameters

**Definition**

```

int sqlite3_bind_blob(    sqlite3_stmt* stmt, int pidx,
                        const void* val, int bytes, mem_callback );
int sqlite3_bind_double( sqlite3_stmt* stmt, int pidx, double val );
int sqlite3_bind_int(    sqlite3_stmt* stmt, int pidx, int val );
int sqlite3_bind_int64(  sqlite3_stmt* stmt, int pidx, sqlite3_int64 val );
int sqlite3_bind_null(   sqlite3_stmt* stmt, int pidx );
int sqlite3_bind_text(   sqlite3_stmt* stmt, int pidx,
                        const char* val, int bytes, mem_callback );
int sqlite3_bind_text16( sqlite3_stmt* stmt, int pidx,
                        const void* val, int bytes, mem_callback );
int sqlite3_bind_value(  sqlite3_stmt* stmt, int pidx,
                        const sqlite3_value* val );
int sqlite3_bind_zeroblob( sqlite3_stmt* stmt, int pidx, int bytes );

void mem_callback( void* ptr );

```

**stmt**

A prepared statement that contains parameter values.

**pidx**

The parameter index. The first parameter has an index of one (1).

**val**

The data value to bind

**bytes**

The size of the data value, in bytes (not characters). Normally, the length does not include any null terminator. If `val` is a null-terminated string, and this value is negative, the length will be automatically computed.

**mem\_callback**

An function pointer to a memory deallocation function. This function frees the memory buffer used to hold the value. If the buffer was allocated with `sqlite3_malloc()`, a reference to `sqlite3_free()` can be passed directly.

The special flags `SQLITE_STATIC` and `SQLITE_TRANSIENT` can also be used. `SQLITE_STATIC` indicates that the application will keep value memory valid until the statement is finalized (or a new value is bound). `SQLITE_TRANSIENT` will cause SQLite to make an internal copy of the value buffer that will be automatically freed when it is no longer needed.

**Returns** (`sqlite3_bind_XXX()`)

An SQLite response code. The code `SQLITE_RANGE` will be returned if the parameter index is invalid.

**Description**

This family of functions is used to bind a data value to a statement parameter. Bound values remain in place until the statement is finalized (via `sqlite3_finalize()`) or a new value is bound to the same parameter index. Resetting the statement via `sqlite3_reset()` does not clear the bindings.



The `sqlite3_bind_zeroblob()` function binds a BLOB object of the given length. All the bytes of the BLOB are set to zero. The BLOB is not actually instanced in memory, allowing the system to bind very large BLOB values. These BLOBs can be modified using the `sqlite3_blob_xxx()` functions.

For more information on how to include statement parameters in prepared SQL statements, see “[Bound Parameters](#)” on page 133.

### See Also

[sqlite3\\_column\\_xxx\(\)](#), [sqlite3\\_result\\_xxx\(\)](#), [sqlite3\\_value\\_xxx\(\)](#)

## sqlite3\_bind\_parameter\_count()

Get the number of statement parameters

### Definition

```
int sqlite3_bind_parameter_count( sqlite3_stmt* stmt );
```

`stmt`

A prepared statement that contains parameter values.

### Returns

The number of valid parameters in this statement.

### Description

This function returns the largest valid statement parameter index in the given statement. If this function returns 6, valid parameter indexes include 1 through 6, inclusive.

### See Also

[sqlite3\\_bind\\_xxx\(\)](#)

## sqlite3\_bind\_parameter\_index()

Get the index of a named statement parameter

### Definition

```
int sqlite3_bind_parameter_index( sqlite3_stmt* stmt, const char *name );
```

`stmt`

A prepared statement that contains parameter values.

`name`

The parameter name, including prefix character. The name must be given in UTF-8.

### Returns

The index of the named parameter. If the name is not found, zero will be returned.

### Description

This function finds the index value of a named statement parameter. The returned value can be safely passed to an `sqlite3_bind_xxx()` function (although those functions may return `SQLITE_RANGE` if the name is not found).

`sqlite3_bind_parameter_name()`

## See Also

[sqlite3\\_bind\\_xxx\(\)](#), [sqlite3\\_bind\\_parameter\\_name\(\)](#)

---

## sqlite3\_bind\_parameter\_name()

Get the name of a statement parameter

### Definition

```
const char* sqlite3_bind_parameter_name( sqlite3_stmt* stmt, int pidx );
```

`stmt`

A prepared statement that contains parameter values.

`pidx`

The parameter index. The first parameter has an index of one (1).

*Returns*

The text representation of the statement parameter with the given index.

### Description

This function looks up the original string representation of a statement parameter. This is most frequently used with named parameters, but works correctly for any explicit parameter type. The string will be UTF-8 encoded, and will include the prefix character (e.g., the parameter `:val` will return `:val`, not `val`). The return value will be NULL if the parameter index is invalid, or if the parameter is an automatic parameter (a bare `?`).

## See Also

[sqlite3\\_bind\\_xxx\(\)](#), [sqlite3\\_bind\\_parameter\\_index\(\)](#)

---

## sqlite3\_blob\_bytes()

Get the size of a BLOB handle value

### Definition

```
int sqlite3_blob_bytes( sqlite3_blob* blob );
```

`blob`

A BLOB handle acquired from `sqlite3_blob_open()`.

*Returns*

The size of the BLOB value, in bytes.

### Description

This function returns the size of the referenced BLOB value in bytes. The size of a BLOB value is fixed and cannot be modified without a call to `INSERT` or `UPDATE`.

## See Also

[sqlite3\\_blob\\_open\(\)](#), [sqlite3\\_bind\\_xxx\(\)](#) (refer to [sqlite3\\_bind\\_zeroblob\(\)](#), specifically), [zeroblob\(\)](#) [Ap E]

---

**sqlite3\_blob\_close()**

Close a BLOB handle

**Definition**

```
int sqlite3_blob_close( sqlite3_blob* blob );
```

**blob**

A BLOB handle acquired from `sqlite3_blob_open()`. It is safe to pass a NULL value.

**Returns**

An SQLite response code.

**Description**

This function closes and releases a BLOB handle acquired from `sqlite3_blob_open()`. The BLOB handle is always closed (and becomes invalid), even if an error code is returned

**See Also**

[sqlite3\\_blob\\_open\(\)](#)

---

**sqlite3\_blob\_open()**

Create and open a BLOB handle

**Definition**

```
int sqlite3_blob_open( sqlite3* db,
    const char* db_name, const char* tbl_name, const char* col_name,
    sqlite3_int64 row_id, int flags, sqlite3_blob** blob );
```

**db**

A database connection.

**db\_name**

A logical database name in UTF-8. This can be `main`, `temp`, or a name given to `ATTACH DATABASE`.

**tbl\_name**

A table name in UTF-8.

**col\_name**

A column name in UTF-8

**row\_id**

A ROWID value.

**flags**

A nonzero value will open the BLOB read/write. A zero value will open the BLOB read-only.

**blob**

A reference to a BLOB handle. The new BLOB handle will be returned via this reference. The BLOB handle may be set to NULL if an error is returned.

**Returns**

An SQLite response code.

sqlite3\_blob\_read()

## Description

This function creates a new BLOB handle used for incremental BLOB I/O. The parameters need to describe the BLOB referenced with the SQL statement:

```
SELECT col_name FROM db_name.tbl_name WHERE ROWID = row_id;
```

The BLOB handle remains valid until it is closed, or until it expires. A BLOB handle expires when any column of the row that contains the BLOB is modified in any way (typically by an UPDATE or DELETE). An expired BLOB handle must still be closed.

When foreign key constraints are enabled, BLOB values contained in columns that are part of a foreign key can only be opened read-only.

## See Also

[sqlite3\\_blob\\_read\(\)](#), [sqlite3\\_blob\\_write\(\)](#), [sqlite3\\_blob\\_close\(\)](#)

---

## sqlite3\_blob\_read()

Read data from a BLOB

### Definition

```
int sqlite3_blob_read( sqlite3_blob* blob, void* buff, int bytes, int offset );
```

**blob**

A BLOB handle acquired from [sqlite3\\_blob\\_open\(\)](#).

**buff**

A data buffer. Data is read from the BLOB into the buffer.

**bytes**

The number of bytes to read from the BLOB into the buffer.

**offset**

Offset from beginning of BLOB where read should start.

*Returns*

An SQLite return code. Attempting to read from an expired BLOB handle will return `SQLITE_ABORT`.

### Description

This function reads the specified number of bytes from a BLOB value into the given buffer. The read will start from the provided offset. Any attempt to read past the end of the BLOB results in an error, meaning that the BLOB must have `bytes + offset` or more bytes.

## See Also

[sqlite3\\_blob\\_bytes\(\)](#), [sqlite3\\_blob\\_open\(\)](#)

---

## sqlite3\_blob\_write()

Write data to a BLOB

### Definition

```
int sqlite3_blob_write( sqlite3_blob* blob, void* buff, int bytes, int offset );
```

**blob**

A BLOB handle acquired from `sqlite3_blob_open()`.

**buff**

A data buffer. Data is written from the buffer into the BLOB.

**bytes**

The number of bytes to write from the buffer into the BLOB.

**offset**

Offset from beginning of BLOB where write should start.

**Returns**

An SQLite return code. Attempting to write to an expired BLOB handle will return `SQLITE_ABORT`.

**Description**

This function writes the specified number of bytes from the given buffer into a BLOB value. The write starts at the provided offset. Any attempt to write past the end of the BLOB results in an error, meaning that the BLOB must have `bytes + offset` or more bytes.

**See Also**

[sqlite3\\_blob\\_bytes\(\)](#), [sqlite3\\_blob\\_open\(\)](#)

**sqlite3\_busy\_handler()**

Register a busy handler

**Definition**

```
int sqlite3_busy_handler( sqlite3* db, busy_handler, void* udp );
```

```
int busy_handler( void* udp, int count );
```

**db**

A database connection.

**busy\_handler**

A function pointer to an application busy handler function.

**udp**

An application-defined user-data pointer. This value is made available to the busy handler.

**count**

The number of times the handler has been called for this lock.

**Returns (sqlite3\_busy\_handler())**

An SQLite result code.

**Returns (busy\_handler())**

A nonzero return code indicates that the connection should continue to wait for the desired lock. A return code of zero indicates that the database connection should give up and return `SQLITE_BUSY` or `SQLITE_IOERR_BLOCKED` to the application.

`sqlite3_busy_timeout()`

## Description

This function registers a busy handler with a specific database connection. The busy handler is called any time the database connection encounters a locked database file. In most cases, the application can simply wait for the lock to be released before proceeding. In these situations, the SQLite library will keep calling the busy handler, which can decide to keep waiting, or to give up and return an error to the application.

For a full discussion of locking states and busy handlers, see the section “[Database Locking](#)” on page 151.

Each database connection has only one busy handler. Registering a new busy handler will replace the old one. To remove a busy handler, pass in a NULL function pointer. Setting a busy timeout with `sqlite3_busy_timeout()` will also reset the busy handler.

## See Also

[sqlite3\\_busy\\_timeout\(\)](#)

---

## sqlite3\_busy\_timeout()

Set a busy timeout

### Definition

```
int sqlite3_busy_timeout( sqlite3* db, int ms );
```

*db*

A database connection.

*ms*

The total timeout duration, in milliseconds (thousandths of a second).

*Returns*

An SQLite result code.

### Description

This function registers an internal busy handler that keeps attempting to acquire a busy lock until the total specified time has passed. Because this function registers an internal busy handler, any current busy handler is removed. The timeout value can be explicitly removed by setting a timeout value of zero.

## See Also

[sqlite3\\_busy\\_handler\(\)](#)

---

## sqlite3\_changes()

Get the number of changes made by an SQL statement

### Definition

```
int sqlite3_changes( sqlite3* db );
```

*db*

A database connection.

*Returns*

The number of rows modified by the last SQL statement that was executed.

**Description**

This function returns the number of rows that were modified by the most recent `INSERT`, `UPDATE`, or `DELETE` statement. Only rows directly affected by the table named in the SQL command are counted. Changes made by triggers, foreign key actions, or conflict resolutions are not counted.

If called from within a trigger, the count only includes modifications made at this trigger level. It will not include changes made by an enclosing scope, nor will it include changes made by subsequent trigger or foreign key actions.

This function is exposed to the SQL environment as the SQL function `changes()`.

**See Also**

[sqlite3\\_total\\_changes\(\)](#), [count\\_changes](#) [PRAGMA, Ap F], [changes\(\)](#) [SQL Func, Ap E]

**sqlite3\_clear\_bindings()**

Reset all statement parameters to NULL

**Definition**

```
int sqlite3_clear_bindings( sqlite3_stmt* stmt );
```

`stmt`

A prepared statement.

*Returns*

An SQLite result code.

**Description**

This function resets all the statement parameters to NULL. It is equivalent to calling `sqlite3_bind_null()` on every valid parameter index. Many applications call this function any time `sqlite3_reset()` is called, to prevent parameter values from leaking from one execution to the next.

**See Also**

[sqlite3\\_bind\\_xxx\(\)](#), [sqlite3\\_reset\(\)](#)

**sqlite3\_close()**

Close a database connection

**Definition**

```
int sqlite3_close( sqlite3* db );
```

`db`

A database connection. A NULL may be safely passed to this function (resulting in a no-op).

sqlite3\_collation\_needed()

### Returns

An SQLite result code.

### Description

This function closes a database connection and releases all the resources associated with it. The application is responsible for finalizing all prepared statements and closing all BLOB handles. If the database connection is currently in a transaction, it will be rolled back before the database(s) are closed. All attached databases will automatically be detached.

If an application fails to finalize a prepared statement, the close will fail and `SQLITE_BUSY` will be returned. The statement must be finalized and `sqlite3_close()` must be called again.

### See Also

[sqlite3\\_open\(\)](#), [sqlite3\\_finalize\(\)](#), [sqlite3\\_close\(\)](#), [sqlite3\\_next\\_stmt\(\)](#)

---

## sqlite3\_collation\_needed()

Register a collation loader

### Definition

```
int sqlite3_collation_needed(  sqlite3* db, void* udp, col_callback  );
int sqlite3_collation_needed16( sqlite3* db, void* udp, col_callback16 );

void col_callback(  void* udp, sqlite3* db, int text_rep, const char* name );
void col_callback16( void* udp, sqlite3* db, int text_rep, const void* name );
```

**db**

A database connection.

**udp**

An application-defined user-data pointer. This value is made available to the collation loader callback.

**col\_callback, col\_callback16**

Function pointer to an application-defined collation loader function.

**text\_rep**

The desired text representation for the requested collation. This value can be one of `SQLITE_UTF8`, `SQLITE_UTF16BE`, or `SQLITE_UTF16LE`.

**name**

The collation name in UTF-8 or UTF-16 (native order).

*Returns* (`sqlite3_collation_needed[16]()`)

An SQLite result code.

### Description

These functions register a collation loader callback function. Any time SQLite is processing an SQL statement that requires an unknown collation, the collation loader callback is called. This provides the application with an opportunity to register the required collation. If the callback is unable to register the requested collation, it should simply return.



Although the callback is given a desired text representation for the requested collation, the callback is under no obligation to provide a collation that uses that specific representation. As long as a collation with the proper name is provided, SQLite will perform whatever translations are required.

This function is most commonly used by applications that provide a very large number of collations. Rather than registering dozens, or even hundreds, of collations with each database connection, the callback allows the collations to be loaded on demand.

## See Also

[sqlite3\\_create\\_collation\(\)](#)

---

## sqlite3\_column\_xxx()

Get a results column value

### Definition

```
const void*      sqlite3_column_blob(  sqlite3_stmt* stmt, int cidx );
double          sqlite3_column_double( sqlite3_stmt* stmt, int cidx );
int             sqlite3_column_int(    sqlite3_stmt* stmt, int cidx );
sqlite3_int64   sqlite3_column_int64(  sqlite3_stmt* stmt, int cidx );
const unsigned char* sqlite3_column_text(  sqlite3_stmt* stmt, int cidx );
const void*     sqlite3_column_text16(  sqlite3_stmt* stmt, int cidx );
sqlite3_value*  sqlite3_column_value(    sqlite3_stmt* stmt, int cidx );
```

*stmt*

A prepared and executed statement.

*cidx*

A column index. The first column has an index of zero (0).

*Returns*

The requested value.

### Description

These functions extract values from a prepared statement. Values are available any time `sqlite3_step()` returns `SQLITE_ROW`. If the requested type is different than the actual underlying value, the value will be converted using the conversion rules defined by [Table 7-1](#).

SQLite will take care of all memory management for the buffers returned by these functions. Pointers returned may become invalid at the next call to `sqlite3_step()`, `sqlite3_reset()`, `sqlite3_finalize()`, or any `sqlite3_column_xxx()` call on the same column index. Pointers can also become invalid because of a call to one of the `sqlite3_column_bytes()` functions.

Be warned that `sqlite3_column_int()` will clip any integer values to 32 bits. If the database contains values that cannot be represented by a 32-bit signed integer, it is safer to use `sqlite3_column_int64()`. The buffer returned by `sqlite3_column_text()` and `sqlite3_column_text16()` will always be null-terminated.

The structure returned by `sqlite3_column_value()` is an unprotected `sqlite3_value` object. This object can only be used in conjunction with `sqlite3_bind_value()` or `sqlite3_result_value()`. Calling any of the `sqlite3_value_xxx()` functions will result in undefined behavior.

`sqlite3_column_bytes()`

## See Also

[sqlite3\\_column\\_count\(\)](#) [C API, Ap G], [sqlite3\\_column\\_bytes\(\)](#) [C API, Ap G], [sqlite3\\_column\\_type\(\)](#) [C API, Ap G], [sqlite3\\_value\\_xxx\(\)](#) [C API, Ap G]

---

## sqlite3\_column\_bytes()

Get the size of a column buffer

### Definition

```
int sqlite3_column_bytes(  sqlite3_stmt* stmt, int cidx );
int sqlite3_column_bytes16( sqlite3_stmt* stmt, int cidx );
```

`stmt`

A prepared and executed statement.

`cidx`

A column index. The first column has an index of zero (0).

*Returns*

The number of bytes in the column value.

### Description

These functions return the number of bytes in a text or BLOB value. Calling these functions can cause a type conversion (invalidating buffers returned by `sqlite3_column_xxx()`), so care must be taken to call them in conjunction with the appropriate `sqlite3_column_xxx()` function.

To avoid problems, an application should first extract the desired type using a `sqlite3_column_xxx()` function, and then call the appropriate `sqlite3_column_bytes()` function. The functions `sqlite3_column_text()` and `sqlite3_column_blob()` should be followed by a call to `sqlite3_column_bytes()`, while any call to `sqlite3_column_text16()` should be followed by a call to `sqlite3_column_bytes16()`.

If these functions are called on a non-text or non-BLOB value, the value will first be converted to an appropriately encoded text value, then the length of that text value will be returned.

## See Also

[sqlite3\\_column\\_xxx\(\)](#)

---

## sqlite3\_column\_count()

Get the number of result columns in a statement

### Definition

```
int sqlite3_column_count( sqlite3_stmt* stmt );
```

`stmt`

A prepared statement.

*Returns*

The number of columns returned by a prepared statement.

## Description

This function returns the number of columns available in a row result. Column indexes start at zero (0), so if this function returns 5, value column indexes are 0 to 4. The value zero (0) is returned if the statement does not return any result.

## See Also

[sqlite3\\_column\\_XXX\(\)](#), [sqlite3\\_step\(\)](#)

## sqlite3\_column\_database\_name()

Get the source database name of a result column

### Definition

```
const char* sqlite3_column_database_name(  sqlite3_stmt* stmt, int cidx );
const void* sqlite3_column_database_name16( sqlite3_stmt* stmt, int cidx );
```

stmt

A prepared statement.

cidx

A column index. The first column has an index of zero (0).

*Returns*

The logical name of the source database for the given result column.

## Description

These functions return the unaliased logical name of the source database that is associated with a SELECT result column. Returned pointers will remain valid until `sqlite3_finalize()` is called on the statement, or until one of these functions is called with the same column index. SQLite will take care of all memory management for the buffers returned by these functions.

Data is only available for result columns that are derived directly from a column reference. If a result column is defined as an expression or subquery, a NULL will be returned.

These functions are only available if the SQLite library was compiled with the `SQLITE_ENABLE_COLUMN_METADATA` build option.

## See Also

[sqlite3\\_column\\_table\\_name\(\)](#), [sqlite3\\_column\\_origin\\_name\(\)](#), `SQLITE_ENABLE_COLUMN_METADATA` [Build Opt, Ap A]

## sqlite3\_column\_decltype()

Get the declared type of a result column

### Definition

```
const char* sqlite3_column_decltype(  sqlite3_stmt* stmt, int cidx );
const void* sqlite3_column_decltype16( sqlite3_stmt* stmt, int cidx );
```

stmt

A prepared statement.

`sqlite3_column_name()`

`cidx`

A column index. The first column has an index of zero (0).

*Returns*

The defined type name for the given result column.

## Description

These functions return the declared type associated with a source column. This is the type that was given in the `CREATE TABLE` command used to define the source table column. Returned pointers will remain valid until `sqlite3_finalize()` is called on the statement, or until one of these functions is called with the same column index. SQLite will take care of all memory management for the buffers returned by these functions.

Data is only available for result columns that are derived directly from a column reference. If a result column is defined as an expression or subquery, a `NULL` will be returned.

## See Also

[sqlite3\\_column\\_type\(\)](#), [sqlite3\\_column\\_table\\_name\(\)](#)

---

## `sqlite3_column_name()`

Get the name of a result column

### Definition

```
const char* sqlite3_column_name(  sqlite3_stmt* stmt, int cidx );
const void* sqlite3_column_name16( sqlite3_stmt* stmt, int cidx );
```

`stmt`

A prepared statement.

`cidx`

A column index. The first column has an index of zero (0).

*Returns*

The name of a result column.

## Description

These functions return the name of a result column. This is the name provided by the `AS` clause of a select header. If no `AS` clause was provided, the name will be derived from the expression used to define the `SELECT` header. The format of derived names is not defined by the SQL standard and may change from one release of SQLite to another. If an application depends on explicit column names, it should always use `AS` clauses in the select header.

Returned pointers will remain valid until `sqlite3_finalize()` is called on the statement, or until one of these functions is called with the same column index. SQLite will take care of all memory management for the buffers returned by these functions.

## See Also

[SELECT](#) [SQL Cmd, Ap C], [full\\_column\\_names](#) [PRAGMA, Ap F], [short\\_column\\_names](#) [PRAGMA, Ap F]

---

**sqlite3\_column\_origin\_name()**

Get the source column name of a result column

**Definition**

```
const char* sqlite3_column_origin_name( sqlite3_stmt* stmt, int cidx );
const void* sqlite3_column_origin_name16( sqlite3_stmt* stmt, int cidx );
```

**stmt**

A prepared statement.

**cidx**

A column index. The first column has an index of zero (0).

**Returns**

The name of the source column for the given result column.

**Description**

These functions return the name of the source column that is associated with a SELECT result column. Returned pointers will remain valid until `sqlite3_finalize()` is called on the statement, or until one of these functions is called with the same column index. SQLite will take care of all memory management for the buffers returned by these functions.

Data is only available for result columns that are derived directly from a column reference. If a result column is defined as an expression or subquery, a NULL will be returned.

These functions are only available if the SQLite library was compiled with the `SQLITE_ENABLE_COLUMN_METADATA` build option.

**See Also**

[sqlite3\\_column\\_name\(\)](#) [C API, Ap G], [sqlite3\\_column\\_table\\_name\(\)](#) [C API, Ap G], [sqlite3\\_column\\_database\\_name\(\)](#) [C API, Ap G], [SQLITE\\_ENABLE\\_COLUMN\\_METADATA](#) [Build Opt, Ap A]

---

**sqlite3\_column\_table\_name()**

Get the source table name of a result column

**Definition**

```
const char* sqlite3_column_table_name( sqlite3_stmt* stmt, int cidx );
const void* sqlite3_column_table_name16( sqlite3_stmt* stmt, int cidx );
```

**stmt**

A prepared statement.

**cidx**

A column index. The first column has an index of zero (0).

**Returns**

The name of the source table for the given result column.

**Description**

These functions return the name of the source table that is associated with a SELECT result column. Returned pointers will remain valid until `sqlite3_finalize()` is called on the

`sqlite3_column_type()`

statement, or until one of these functions is called with the same column index. SQLite will take care of all memory management for the buffers returned by these functions.

Data is only available for result columns that are derived directly from a column reference. If a result column is defined as an expression or subquery, a NULL will be returned.

These functions are only available if the SQLite library was compiled with the `SQLITE_ENABLE_COLUMN_METADATA` build option.

### See Also

[sqlite3\\_column\\_database\\_name\(\)](#) [C API, Ap G], [sqlite3\\_column\\_origin\\_name\(\)](#) [C API, Ap G], [SQLITE\\_ENABLE\\_COLUMN\\_METADATA](#) [Build Opt, Ap A]

---

## sqlite3\_column\_type()

Get the datatype of a result column

### Definition

```
int sqlite3_column_type( sqlite3_stmt* stmt, int cidx );
```

`stmt`

A prepared and executed statement.

`cidx`

A column index. The first column has an index of zero (0).

*Returns*

The native datatype code of a result value.

### Description

This function returns the initial datatype of the value in a result column. For a given column, this value may change from one result row to the next. If this function is used, it should be called before any `sqlite3_column_xxx()` function. Once a type conversion takes place, the result of this function is undefined.

The return value will be `SQLITE_INTEGER`, `SQLITE_FLOAT`, `SQLITE_TEXT`, `SQLITE_BLOB`, or `SQLITE_NULL`.

### See Also

[sqlite3\\_column\\_xxx\(\)](#), [sqlite3\\_step\(\)](#)

---

## sqlite3\_commit\_hook()

Register a commit callback

### Definition

```
void* sqlite3_commit_hook( sqlite3* db, commit_callback, void* udp );
```

```
int commit_callback( void* udp );
```

`db`

A database connection.

**commit\_callback**

Function pointer to an application-defined commit callback function.

**udp**

An application-defined user-data pointer. This value is made available to the commit callback.

**Returns** (`sqlite3_commit_hook()`)

The previous user-data pointer, if applicable.

**Returns** (`commit_callback()`)

If nonzero, the commit is converted into a callback.

**Description**

This function registers a commit callback. This callback function is called any time the database performs a commit (including an autocommit). Each database connection can have only one commit callback. Registering a new commit callback will overwrite any previously registered callback. To remove the commit callback, set a NULL function pointer.

A commit callback must not use the associated database connection to modify any databases, nor may it call `sqlite3_prepare_v2()` or `sqlite3_step()`. If the commit callback returns a nonzero value, the commit will be canceled and the transaction will be rolled back.

**See Also**

[sqlite3\\_rollback\\_hook\(\)](#), [sqlite3\\_update\\_hook\(\)](#)

**sqlite3\_compileoption\_get()**

Iterate over defined compile options

**Definition**

```
const char* sqlite3_compileoption_get( int iter );
```

**iter**

An iterator index value.

**Returns**

A UTF-8 encoded string with the option name and optional value.

**Description**

This function iterates over all the build options used to compile this instance of the SQLite library. By starting with an iterator value of zero (0) and calling this function over and over with an ever-increasing iterator value, all of the defined values will be returned. If the iterator value is out of range, a NULL pointer will be returned.

Only build options that were actually given will be included. Those that assumed their default values will not be given. Generally, only `ENABLE`, `DISABLE`, `OMIT`, and a few other directives are included in the list. `DEFAULT` and `MAX` directives that control limits or default values are not included. Most of these values can be queried with `sqlite3_limit()`.

sqlite3\_compileoption\_used()

If the build option is a simple Boolean, only the option name will be included. If the option requires an actual value, the option will be given as *name=value*. In both cases, the `SQLITE_` prefix will not be included.

This function is exposed to the SQL environment as the SQL function `sqlite_compileoption_get()`. Note that the SQL function has no `3` in the name.

### See Also

[sqlite3\\_compileoption\\_used\(\)](#), [sqlite3\\_compileoption\\_get\(\)](#), [sqlite\\_compileoption\\_get\(\)](#) [SQL Func, Ap E]

---

## sqlite3\_compileoption\_used()

Get a compile option value

### Definition

```
int sqlite3_compileoption_used( const char* name );
```

name

A UTF-8 encoded string with the option name and, optionally, the value.

### Returns

A Boolean that indicates if the specified compile option and, optionally, the value was used.

### Description

This function queries if a specific compile option (and, possibly, value) was used to compile this instance of the SQLite library. This function is aware of the same build options that `sqlite3_compileoption_get()` returns. The function will work with or without the `SQLITE_` prefix.

In the case of a Boolean build option, the name should just be the build option itself. The return value will indicate if the option was used or not. In the case of build options that require an actual value, the name can either include just the name, or it can include a name-value pair in the format *name=value*. If just the name is given, the return value will indicate if the build option was used with any value. If the value is given, the return value will indicate if the build option was set to that specific value.

This function is exposed to the SQL environment as the SQL function `sqlite_compileoption_used()`. Note that the SQL function has no `3` in the name.

### See Also

[sqlite3\\_compileoption\\_get\(\)](#), [sqlite\\_compileoption\\_used\(\)](#) [SQL Func, Ap E]

---

## sqlite3\_complete()

Determine if an SQL statement is complete

### Definition

```
int sqlite3_complete( const char* sql );  
int sqlite3_complete16( const void* sql );
```



sql

An SQL statement.

*Returns*

Zero (0) if the statement is incomplete, `SQLITE_NOMEM` if a memory allocation failed, or a nonzero value to indicate the statement is complete.

### Description

This function determines if an SQL statement is complete. This function will return a nonzero result if the given string ends in a semicolon that is not part of an identifier, string literal, or `CREATE TRIGGER` statement. Although the statement is scanned, it is not fully parsed and cannot detect syntactically incorrect statements.

The function `sqlite3_initialize()` should be called before using this function. If the SQLite library has not been initialized, this function will do so automatically. This may result in additional nonzero result codes if the initialization fails.

### See Also

[sqlite3\\_prepare\\_xxx\(\)](#)

## sqlite3\_config()

Advanced configuration of the SQLite library

### Definition

```
int sqlite3_config( int option, ... );
```

option

The configuration option to change.

*Additional parameters*

Additional parameters are determined by the given configuration option.

*Returns*

An SQLite result code.

### Description

This function configures the SQLite library. It must be called before the SQLite library finishes its initialization process (either before `sqlite3_initialize()` returns, or after `sqlite3_shutdown()` is called). The number of additional parameters and their types is determined by the specific configuration option.

In addition to controlling the threading mode, this function can also be used to control many different aspects of SQLite's memory usage. Setting these configuration parameters is an advanced feature that is not required by the vast majority of applications.

For more information on the currently supported configuration options, see [http://www.sqlite.org/c3ref/c\\_config\\_getmalloc.html](http://www.sqlite.org/c3ref/c_config_getmalloc.html).

### See Also

[sqlite3\\_initialize\(\)](#), [sqlite3\\_db\\_config\(\)](#), [sqlite3\\_limit\(\)](#)

---

**sqlite3\_context\_db\_handle()**

Get a database connection from a function context

**Definition**

```
sqlite3* sqlite3_context_db_handle( sqlite3_context* ctx );
```

ctx

An SQL function context, provided by the SQLite library.

*Returns*

The database connection associated with this context.

**Description**

This function returns the database connection that is associated with an SQL function context. This is called from inside a C function that implements a custom SQL function or SQL aggregate.

**See Also**

[sqlite3\\_create\\_function\(\)](#)

---

**sqlite3\_create\_collation()**

Register a custom collation implementation

**Definition**

```
int sqlite3_create_collation(  sqlite3* db, const char* name, int text_rep,
                             void* udp, comp_func );
int sqlite3_create_collation16( sqlite3* db, const void* name, int text_rep,
                               void* udp, comp_func );
int sqlite3_create_collation_v2( sqlite3* db, const char* name, int text_rep,
                                void* udp, comp_func, dest_func );

int comp_func( void* udp, int sizeA, const void* textA,
              int sizeB, const void* textB );
void dest_func( void* udp );
```

db

A database connection.

name

The name of the collation in UTF-8 or UTF-16, depending on the function used.

text\_rep

The text representation expected by the comparison function. This value can be one of `SQLITE_UTF8`, `SQLITE_UTF16` (native order), `SQLITE_UTF16BE`, `SQLITE_UTF16LE`, or `SQLITE_UTF16_ALIGNED` (native order, 16-bit aligned).

udp

An application-defined user-data pointer. This value is made available to both the collation comparison function and the collation destroy function.

**comp\_func**

A function pointer to the application-defined custom collation comparison function.

**dest\_func**

An optional function pointer to the application-defined collation destroy function. This may be NULL.

**sizeA, sizeB**

The length of the `textA` and `textB` parameters, respectively, in bytes.

**textA, textB**

Data buffers containing the text values in the requested representation. These may not be null-terminated.

*Returns (sqlite3\_create\_collation[16][\_v2]())*

An SQLite result code.

*Returns (comp\_func())*

The results of the comparison. Negative for  $A < B$ , zero for  $A = B$ , positive for  $A > B$ .

## Description

These functions define a custom collation implementation. This is done by registering a comparison function under the given collation name and expected text representation.

The only difference between `sqlite3_create_collation()` and `sqlite3_create_collation16()` is the text encoding used to define the collation name (the second parameter). The encoding used when calling the comparison function is determined by the third parameter. Either function can be used to register a comparison function that understands any of the given encodings.

The only difference between `sqlite3_create_collation()` and `sqlite3_create_collation_v2()` is the addition of the destroy callback function.

A collation name can be overloaded by registering multiple comparison functions under different expected text representations. To delete a collation, register a NULL comparison function pointer under the same collation name and text representation.

The comparison function should return a negative value if `testA` is less than `testB`, a zero value if `testA` and `testB` are equal, or a positive value if `testA` is greater than `testB`. Conceptually, the return value represents  $A - B$ .

The destroy function is called any time a collation is overwritten or when the database connection is shut down. The destroy function will be passed the user-data pointer and given a chance to deallocate any relevant memory. If applicable, a reference to `sqlite3_free()` can be passed directly to `sqlite3_create_collation_v2()`.

For more information on writing custom collations, see [“Collation Functions” on page 200](#).

## See Also

[sqlite3\\_create\\_function\(\)](#), [sqlite3\\_collation\\_needed\(\)](#)

---

**sqlite3\_create\_function()**

Define a scalar or aggregate SQL function

**Definition**

```
int sqlite3_create_function(  sqlite3* db, const char* name, int num_param,
                             int text_rep, void* udp, func_func, step_func, final_func );
int sqlite3_create_function16( sqlite3* db, const void* name, int num_param,
                              int text_rep, void* udp, func_func, step_func, final_func );

void func_func(  sqlite3_context* ctx, int argc, sqlite3_value** argv );
void step_func(  sqlite3_context* ctx, int argc, sqlite3_value** argv );
void final_func( sqlite3_context* ctx );
```

**db**

A database connection.

**name**

The name of the collation in UTF-8 or UTF-16, depending on the function used.

**num\_param**

The number of expected parameters in the SQL function. If the value is -1, any number of parameters will be accepted.

**text\_rep**The text representation best suited to the function(s). This value can be one of `SQLITE_UTF8`, `SQLITE_UTF16` (native order), `SQLITE_UTF16BE`, `SQLITE_UTF16LE`, or `SQLITE_ANY`.**udp**An application-defined user-data pointer. This value can be extracted from the `ctx` parameter using the `sqlite3_user_data()` function.**func\_func**A function pointer to an application-defined scalar SQL function implementation. If this is non-NULL, the `step_func` and `final_func` parameters must be NULL.**step\_func**A function pointer to an application-defined aggregate step function implementation. If this is non-NULL, the `func_func` parameter must be NULL and the `final_func` parameter must be non-NULL.**final\_func**A function pointer to an application-defined aggregate finalize function implementation. If this is non-NULL, the `func_func` parameter must be NULL and the `step_func` parameter must be non-NULL.**ctx**

An SQL function context, provided by the SQLite library.

**argc**

The number of parameters given to the SQL function.

**argv**

The parameter values passed into the SQL function.

**Returns** (`sqlite3_create_function[16]()`)

An SQLite result code.

## Description

These functions are used to define custom SQL scalar functions or SQL aggregate functions. This is done by registering C function pointers that implement the desired SQL function.

The only difference between `sqlite3_create_function()` and `sqlite3_create_function16()` is the text encoding used to define the function name (the second parameter). The encoding used when calling the registered functions is determined by the fourth parameter. Either function can be used to register functions that understands any of the given encodings.

A single call to one of these functions can be used to define either an SQL scalar function or an SQL aggregate function, but not both. A scalar function is defined by providing a valid `func_func` parameter and setting `step_func` and `final_func` to NULL. Conversely, an aggregate function is defined by providing a valid `step_func` and `final_func` while setting `func_func` to NULL.

By providing different values for the `num_param` or `text_rep` (or both) parameters, different functions can be registered under the same SQL function name. SQLite will choose the closest fit, first by parameter number and then by text representation. An explicit parameter number is considered a better fit than a variable length function. Text representations are judged by those that require the least amount of conversion.

Both scalar and aggregate functions can be defined under the same name, assuming they accept a different number of parameters. SQLite uses this functionality internally to define both scalar and aggregate `max()` and `min()` functions.

A function can be redefined by registering a new set of function pointers under the same name, parameter number, and text representation. This functionality can be used to override existing functions (including built-in functions). To unregister a function, simply pass in all NULL function pointers.

Finally, there is one significant limitation to `sqlite3_create_function()`. Although new functions can be defined at any time, it is not legal to redefine or delete a function when there are active statements. Because existing statements may contain references to the existing SQL functions, all prepared statements must be invalidated when redefining or deleting a function. If there are active statements in the middle of executing, this is not possible, and will cause `sqlite3_create_function()` to fail.

For more information on how to write custom SQL scalar and aggregate functions, see [Chapter 9](#).

## See Also

[sqlite3\\_create\\_collation\(\)](#) [C API, Ap G], [sqlite3\\_user\\_data\(\)](#) [C API, Ap G], [sqlite3\\_context\\_db\\_handle\(\)](#) [C API, Ap G], [sqlite3\\_value\\_xxx\(\)](#) [C API, Ap G], [sqlite3\\_result\\_xxx\(\)](#) [C API, Ap G]

---

**sqlite3\_create\_module()**

Register a virtual table implementation [EXP]

**Definition**

```
int sqlite3_create_module(    sqlite3* db, const char* name,
                            const sqlite3_module* mod_struct, void* udp );
int sqlite3_create_module_v2( sqlite3* db, const char* name,
                             const sqlite3_module* mod_struct, void* udp, dest_func );

void dest_func( void* udp );
```

**db**

A database connection.

**name**

The name of the module (the virtual table type), in UTF-8.

**mod\_struct**

A module structure, which includes function pointers to all of the application-defined functions required to implement a virtual table module.

**udp**

An application-defined user-data pointer. This value is made available to some of the virtual table functions, as well as the destructor function.

**dest\_func**

An optional function pointer to the module destroy function. This may be NULL.

*Returns* (sqlite3\_create\_module[\_v2]())

An SQLite result code.

**Description**

These functions register a virtual table module. The only difference between the standard and `_v2` version is the addition of the destroy function, which can be used to free any memory allocations associated with the user-data pointer.

For more information on writing a virtual table module, see [Chapter 10](#).

**See Also**[sqlite3\\_declare\\_vtab\(\)](#)

---

**sqlite3\_data\_count()**

Get the number of valid result columns in a statement

**Definition**

```
int sqlite3_data_count( sqlite3_stmt* stmt );
```

**stmt**

A prepared statement.

*Returns*

The number of columns available in a prepared statement.

## Description

This function returns the number of columns available in a row result. Column indexes start at zero (0), so if this function returns 5, value column indexes are 0 to 4. The value zero (0) will be returned if there is no current result row.

This function is almost identical to `sqlite3_column_count()`. The main difference is that this function will return zero (0) if no valid result row is currently available (for example, before `sqlite3_step()` is called), while `sqlite3_column_count()` will always return the number of expected columns, even if no row is currently available.

## See Also

[sqlite3\\_column\\_count\(\)](#)

## sqlite3\_db\_config()

Advanced configuration of a database connection [EXP]

### Definition

```
int sqlite3_db_config( sqlite3* db, int option, ... );
```

`db`

A database connection.

`option`

The configuration option to change.

### Additional Parameters

Additional parameters are determined by the given configuration option.

### Returns

An SQLite result code.

## Description

This function configures database connections. It must be called immediately following a call to one of the `sqlite3_open_XXX()` functions.

For more information on the currently supported configuration options, see [http://www.sqlite.org/c3ref/c\\_dbconfig\\_lookaside.html](http://www.sqlite.org/c3ref/c_dbconfig_lookaside.html).

## See Also

[sqlite3\\_config\(\)](#), [sqlite3\\_limit\(\)](#)

## sqlite3\_db\_handle()

Get database connection from statement

### Definition

```
sqlite3* sqlite3_db_handle( sqlite3_stmt* stmt );
```

`stmt`

A prepared statement.

sqlite3\_db\_mutex()

#### Returns

The database connection associated with the provided statement.

#### Description

This function extracts the database connection associated with a prepared statement.

#### See Also

[sqlite3\\_prepare\\_xxx\(\)](#)

---

## sqlite3\_db\_mutex()

Extract a database connection mutex lock

#### Definition

```
sqlite3_mutex* sqlite3_db_mutex( sqlite3* db );
```

db

A database connection.

#### Returns

The database connection mutex lock. If the library is not in the “serialized” threading mode, a NULL pointer will be returned.

#### Description

This function extracts and returns a reference to the mutual exclusion lock associated with the given database connection. The SQLite library must be in the “serialized” threading mode. If it is in any other mode, this function will return NULL.

The mutex object can be used to lock the database connection for the purpose of avoiding race conditions, especially when accessing error messages or row counts that are stored as part of the database connection.

#### See Also

[sqlite3\\_mutex\\_enter\(\)](#), [sqlite3\\_mutex\\_leave\(\)](#)

---

## sqlite3\_db\_status()

Get the status of a database connection resource [EXP]

#### Definition

```
int sqlite3_db_status( sqlite3* db, int option,  
                     int* current, int* highest, int reset);
```

db

A database connection.

option

The resource option to retrieve.

current

The current value of the given option will be passed back through this reference.



**highest**

The highest seen value of the given option will be passed back through this reference.

**reset**

If this value is nonzero, the highest seen value will be reset to the current value.

**Returns**

An SQLite result code.

**Description**

This function can be used to query information about the internal resource usage of a database connection. The function will pass back both the current and the highest seen values. This can be used to track resource consumption.

For more information on the currently supported status options, see [http://www.sqlite.org/c3ref/db\\_status.html](http://www.sqlite.org/c3ref/db_status.html).

**See Also**

[sqlite3\\_status\(\)](#), [sqlite3\\_stmt\\_status\(\)](#)

**sqlite3\_declare\_vtab()**

Define the schema of a virtual table [EXP]

**Definition**

```
int sqlite3_declare_vtab( sqlite3* db, const char *sql );
```

**db**

A database connection.

**sql**

A UTF-8 encoded string that contains an appropriately formatted CREATE TABLE statement.

**Returns**

An SQLite result code.

**Description**

This function is used by a virtual table module to define the schema of the virtual table.

For more information on writing a virtual table module, see [Chapter 10](#).

**See Also**

[sqlite3\\_create\\_module\(\)](#)

**sqlite3\_enable\_load\_extension()**

Enable or disable dynamic extension loading

**Definition**

```
int sqlite3_enable_load_extension( sqlite3* db, int enabled );
```

sqlite3\_enable\_shared\_cache()

db

A database connection.

enabled

An enable/disable flag. A nonzero value will enable dynamic modules, while a zero value will disable them.

*Returns*

An SQLite result code.

## Description

This function enables or disables the ability to load dynamic modules. For security reasons, dynamic modules are disabled by default and must be explicitly enabled.

## See Also

[sqlite3\\_load\\_extension\(\)](#)

---

## sqlite3\_enable\_shared\_cache()

Enable or disable shared cache mode

### Definition

```
int sqlite3_enable_shared_cache( int enabled );
```

enabled

An enable/disable flag. A nonzero flag will enable shared cache mode, while a zero value will disable it.

*Returns*

An SQLite result code.

## Description

This function enables or disables shared cache across database connections. By default, shared cache mode is disabled. If enabled, an application that uses multiple database connections to the same database will share page caches and other management data. This can reduce memory usage and I/O, but there are also a number of minor limitations associated with having shared cache mode enabled.

Altering the cache mode will not change any existing database connections. It will only affect the mode used by new database connections created with an `sqlite3_open_xxx()` function.

For more information on shared cache mode, see <http://www.sqlite.org/sharedcache.html>.

## See Also

[sqlite3\\_open\(\)](#), [sqlite3\\_open\\_v2\(\)](#)

---

## sqlite3\_errcode()

Get error code for last failed API call

### Definition

```
int sqlite3_errcode( sqlite3* db );
```

db

A database connection.

#### Returns

An error code or extended error code.

### Description

This function returns the error code from the last failed `sqlite3_*` API call associated with this database connection. If extended error codes are enabled, this function may also return an extended error code. If a failed call was followed by a successful call, the results are undefined.

If the SQLite library is in “serialized” threading mode, there is a risk of a race condition between threads. To avoid problems, the current thread should use `sqlite3_mutex_enter()` to acquire exclusive access to the database connection before the initial API call is made. The thread can release the mutex after `sqlite3_errcode()` is called. In “multi-thread” mode, it is the responsibility of the application to control access to the database connection.

If an API call returns `SQLITE_MISUSE`, it indicates an application error. In that case, the result code may or may not be available to `sqlite3_errcode()`.

### See Also

[sqlite3\\_errmsg\(\)](#) [C API, Ap G], [sqlite3\\_extended\\_result\\_codes\(\)](#) [C API, Ap G], [sqlite3\\_extended\\_errcode\(\)](#) [C API, Ap G], [sqlite3\\_mutex\\_enter\(\)](#) [C API, Ap G]

## sqlite3\_errmsg()

Get an error string from last failed API call

### Definition

```
const char* sqlite3_errmsg(  sqlite3* db );
const void* sqlite3_errmsg16( sqlite3* db );
```

db

A database connection.

#### Returns

Human-readable error message, in English.

### Description

This function returns the error message from the last failed `sqlite3_*` API call associated with this database connection. If a failed call was followed by a successful call, the results are undefined.

Most of SQLite’s built-in error messages are extremely terse and somewhat cryptic. Although the error messages are useful for logging and debugging, most applications should provide their own end-user error messages.

If SQLite is being used in a threaded environment, this function is subject to the same concerns as `sqlite3_errcode()`.

sqlite3\_exec()

If an API call returns `SQLITE_MISUSE`, it indicates an application error. In that case, the result code may or may not be available to `sqlite3_errmsg()`.

### See Also

[sqlite3\\_errcode\(\)](#)

---

## sqlite3\_exec()

Execute SQL statements

### Definition

```
int sqlite3_exec( sqlite3* db, const char* sql,
                 exec_callback, void* udp, char** errmsg );

int exec_callback( void* udp, int c_num, char** c_vals, char** c_names );
```

**db**

A database connection.

**sql**

A null-terminated, UTF-8 encoded string that contains one or more SQL statements. If more than one SQL statement is provided, they must be separated by semicolons.

**exec\_callback**

An optional callback function. This application-defined callback is called once for each row in the result set. If set to `NULL`, no result data will be made available.

**udp**

An application-defined user-data pointer. This value is made available to the `exec` callback function.

**errmsg**

An optional reference to a string pointer. If the function returns anything other than `SQLITE_OK`, an error message will be passed back. If no error is encountered, the pointer will be set to `NULL`. The reference may be `NULL` to ignore error messages. Error messages must be freed with `sqlite3_free()`.

**c\_num**

The number of columns in the current result row.

**c\_vals**

An array of UTF-8 strings that contain the values of the current result row. These values are generated with `sqlite3_column_text()` and use the same conversion rules. There is no way to determine the original datatype of the value.

**c\_names**

An array of UTF-8 strings that contain the column names of the current result row. These are generated with `sqlite3_column_name()`.

*Returns* (`sqlite3_exec()`)

An SQLite result code.

Returns (`exec_callback()`)

If the callback returns a nonzero value, execution of the current statement is halted and `sqlite3_exec()` will immediately return `SQLITE_ABORT`.

### Description

This function is a convenience function used to run SQL statements in one step. This function will prepare and step through one or more SQL statements, calling the provided callback with each result row. The callback can then process each row of the results. The callback should not attempt to free the memory used to hold the column names or value strings. All result values are given as strings.

Although `sqlite3_exec()` is an easy way to execute standalone SQL statements, it does not allow the use of statement parameters. This can lead to performance and security concerns for statements that require application-defined values. Manually preparing and executing the statement allows the use of statement parameters and the `sqlite3_bind_xxx()` functions.

This function has no performance advantage over the explicit `sqlite3_prepare()` and `sqlite3_step()` functions. In fact, `sqlite3_exec()` uses those functions internally.

### See Also

[sqlite3\\_column\\_xxx\(\)](#) (in specific, [sqlite3\\_column\\_text\(\)](#)), [sqlite3\\_column\\_name\(\)](#), [sqlite3\\_prepare\\_xxx\(\)](#), [sqlite3\\_step\(\)](#)

## sqlite3\_extended\_errcode()

Get extended error code for last failed API call

### Definition

```
int sqlite3_extended_errcode( sqlite3* db );
```

`db`

A database connection.

Returns

An extended error code.

### Description

This function is similar to `sqlite3_errcode()`, except that it will always return an extended error code, even if extended result codes are not enabled.

If SQLite is being used in a threaded environment, this function is subject to the same concerns as `sqlite3_errcode()`.

If an API call returns `SQLITE_MISUSE`, it indicates an application error. In that case, the result code may or may not be available to `sqlite3_extended_errcode()`.

### See Also

[sqlite3\\_errcode\(\)](#), [sqlite3\\_extended\\_result\\_codes\(\)](#)

---

**sqlite3\_extended\_result\_codes()**

Enable or disable extended result codes

**Definition**

```
int sqlite3_extended_result_codes( sqlite3* db, int enabled );
```

**db**

A database connection.

**enabled**

A nonzero value indicates that extended result codes should be turned on, while a zero value indicates that extended result codes should be turned off.

*Returns*

An SQLite result code.

**Description**

This function is used to enable extended result codes. Extended codes are off by default. When enabled, any API function that returns an SQLite result code may return an extended code. The extended code is always available using `sqlite3_extended_errcode()`.

**See Also**

[sqlite3\\_errcode\(\)](#) , [sqlite3\\_extended\\_errcode\(\)](#)

---

**sqlite3\_file\_control()**

Low-level control of database files

**Definition**

```
int sqlite3_file_control( sqlite3* db, const char *name,
                        int option, void* data );
```

**db**

A database connection.

**name**The destination logical database name in UTF-8. This can be `main`, `temp`, or the logical name given to `ATTACH DATABASE`.**option**

A configuration option value.

**data**A configuration data value. The exact meaning is typically determined by the value of the `option` parameter.*Returns*

An SQLite result code or other value.

**Description**

This function allows an application to interact with the low-level file I/O layer within SQLite. The `option` and `data` parameters will be passed to the appropriate VFS (Virtual File System) driver's `xFileControl()` function.

**See Also**

[sqlite3\\_vfs\\_register\(\)](#)

**sqlite3\_finalize()**

Finalize and release a prepared statement

**Definition**

```
int sqlite3_finalize( sqlite3_stmt* stmt );
```

`stmt`

A prepared statement

*Returns*

An SQLite result code.

**Description**

This function finalizes prepared statements. Finalizing a statement releases any internal resources and deallocates any memory. Once a statement has been finalized, it is no longer valid and cannot be reused.

**See Also**

[sqlite3\\_prepare\\_xxx\(\)](#), [sqlite3\\_step\(\)](#)

**sqlite3\_free()**

Free a memory allocation

**Definition**

```
void sqlite3_free( void* ptr );
```

`ptr`

A pointer to a memory allocation.

**Description**

This function releases a memory block that was previously allocated with `sqlite3_malloc()` or `sqlite3_realloc()`. This should not be used to release memory acquired through a native `malloc()` or `new` call.

**See Also**

[sqlite3\\_malloc\(\)](#), [sqlite3\\_realloc\(\)](#)

---

## sqlite3\_free\_table()

Release table structure

### Definition

```
void sqlite3_free_table( char** result );
```

result

An array of table values returned by `sqlite3_get_table()`.

### Description

This function properly releases the value array returned by `sqlite3_get_table()`.

### See Also

[sqlite3\\_get\\_table\(\)](#)

---

## sqlite3\_get\_autocommit()

Get the current transaction mode

### Definition

```
int sqlite3_get_autocommit( sqlite3* db );
```

db

A database connection.

### Returns

A nonzero value if the given database connection is in autocommit mode, a zero value if it is not.

### Description

This function returns the current transaction mode. A nonzero return value indicates that the given database connection is in autocommit mode, meaning that no explicit transaction is open. A return value of zero means that an explicit transaction is in progress.

If an error is encountered while in an explicit transaction, there may be times when SQLite is forced to roll back the transaction. This function can be used to detect if the rollback happened or not.

### See Also

[BEGIN TRANSACTION](#) [SQL Cmd, Ap C]

---

## sqlite3\_get\_auxdata()

Get auxiliary data from a function parameter

### Definition

```
void* sqlite3_get_auxdata( sqlite3_context* ctx, int pidx );
```

ctx

An SQL function context, provided by the SQLite library.

pidx

A function parameter index. The first parameter has an index of zero (0).



*Returns*

A user-defined data pointer set with `sqlite3_set_auxdata()`.

**Description**

This function is used by an SQL function implementation to retrieve any application-defined auxiliary data that may have been attached to a function parameter with `sqlite3_set_auxdata()`. If no data is available, or the data has been cleared, this function will return NULL.

**See Also**

[sqlite3\\_set\\_auxdata\(\)](#), [sqlite3\\_value\\_xxx\(\)](#)

**sqlite3\_get\_table()**

Get a result table

**Definition**

```
int sqlite3_get_table( sqlite3* db, const char sql, char*** result,
                    int* num_rows, int* num_cols, char** errmsg );
```

**db**

A database connection.

**sql**

A null-terminated, UTF-8 encoded string that contains one or more SQL statements. If more than one SQL statement is provided, they must be separated by semicolons.

**result**

A reference to an array of strings. The results of the query are passed back using this reference. The value passed back must be freed with a call to `sqlite3_free_table()`.

**num\_rows**

The number of rows in the result, not including the column names.

**num\_cols**

The number of columns in the result.

**errmsg**

An optional reference to a string. If an error occurs, the reference will be set to an error message. The application is responsible for freeing the message with `sqlite3_free()`. If no error occurs, the reference will be set to NULL. The reference may be NULL.

*Returns*

An SQLite result code.

**Description**

This function takes an SQL statement, executes it, and passes back the full result set. If more than one SQL statement is given in an SQL string, all the statements must have a result set with the same number of columns.

`sqlite3_initialize()`

The result is an array of strings with  $(\text{num\_rows} + 1) * \text{num\_cols}$  values. The first `num_cols` values are the column names, followed by individual rows. To access the value of a specific column and row, use the formula  $(\text{row} + 1) * \text{num\_cols} + \text{col}$ , assuming the `row` and `col` indexes start with zero (0).

### See Also

[sqlite3\\_free\\_table\(\)](#), [sqlite3\\_free\(\)](#)

---

## sqlite3\_initialize()

Initialize the SQLite library

### Definition

```
int sqlite3_initialize( );
```

### Returns

An SQLite result code.

### Description

This function initializes the SQLite library. It can be safely called multiple times. Many standard SQLite functions, such as `sqlite3_open()`, will automatically call `sqlite3_initialize()` if it was not explicitly called by the application. The SQLite library can be safely initialized and shut down repeatedly.

### See Also

[sqlite3\\_open\(\)](#), [sqlite3\\_shutdown\(\)](#)

---

## sqlite3\_interrupt()

Cancel any in-progress database operations.

### Definition

```
void sqlite3_interrupt( sqlite3* db );
```

`db`

A database connection.

### Description

This function causes all currently running statements to abort at their earliest convenience. It is safe to call this from a different thread. Interrupted functions will return `SQLITE_INTERRUPT`. If the interrupted function is modifying the database file and is inside an explicit transaction, the transaction will be rolled back. The interrupt state will continue until the active statement count reaches zero.

This function should not be called if the database connection may be closed. A crash is likely if the database connection is closed while an interrupt is still outstanding.

### See Also

[sqlite3\\_close\(\)](#)

---

## sqlite3\_last\_insert\_rowid()

Get the last inserted ROWID

### Definition

```
sqlite3_int64 sqlite3_last_insert_rowid( sqlite3* db );
```

db

A database connection.

### Returns

The value of the last inserted ROWID.

### Description

This function returns the ROWID of the last successfully inserted row. If no rows have been inserted since the database connection was opened, this function will return zero (0). Note that zero is a valid ROWID, but it will never be automatically assigned by SQLite. This function is typically used to get the automatically generated value for a newly inserted record. The value is often used to populate foreign keys.

If the INSERT happens inside of a trigger, the inserted ROWID value is valid for the duration of the trigger. Once the trigger exits, the value returns to its previous value.

If the SQLite library is in “serialized” threading mode, there is a risk of a race condition between threads. To avoid problems, the current thread should use `sqlite3_mutex_enter()` to acquire exclusive access to the database connection before the initial API call is made. The thread can release the mutex after `sqlite3_last_insert_rowid()` is called. In “multithread” mode, it is the responsibility of the application to control access to the database connection.

This function is exposed to the SQL environment as the SQL function `last_insert_rowid()`.

### See Also

[last\\_insert\\_rowid\(\)](#) [SQL Func, Ap E]

---

## sqlite3\_libversion()

Get the SQLite library version

### Definition

```
const char* sqlite3_libversion( );
```

### Returns

The SQLite library version as a UTF-8 encoded string.

### Description

This function returns the SQLite library version as a string. The version string for SQLite v3.6.23 is "3.6.23". The version string for v3.6.23.1 is "3.6.23.1".

This value is also available at compile time as the `SQLITE_VERSION` macro. By comparing the macro used at compile time to the value returned at runtime, an application can verify that it is linking against the correct version of the library.

`sqlite3_libversion_number()`

This function is exposed to the SQL environment as the SQL function `sqlite_version()`.

### See Also

[sqlite3\\_libversion\\_number\(\)](#), [sqlite3\\_sourceid\(\)](#), [sqlite\\_version\(\)](#) [SQL Func, Ap E]

---

## sqlite3\_libversion\_number()

Get the SQLite library version

### Definition

```
int sqlite3_libversion_number( );
```

### Returns

The SQLite library version as a number.

### Description

This function returns the SQLite library version as an integer. The number is in the form `Mmmpppp`, with `M` being the major version, `m` the minor, and `p` the point release. Smaller steps are not included. The version number of SQLite v3.6.23.1 (and v3.6.23) is `3006023`.

This value is also available at compile time as the `SQLITE_VERSION_NUMBER` macro. By comparing the macro used at compile time to the value returned at runtime, an application can verify that it is linking against a proper version of the library.

### See Also

[sqlite3\\_libversion\(\)](#), [sqlite3\\_sourceid\(\)](#)

---

## sqlite3\_limit()

Get or set SQLite library limits and maximums

### Definition

```
int sqlite3_limit( sqlite3* db, int limit, int value );
```

`db`

A database connection.

`limit`

The specific limit to set.

`value`

The new value. If the value is negative, the value will not be set (and the current value will be returned).

### Returns

The previous value.

### Description

This function gets or sets several of the database connection limits. The limits can be lowered at runtime on a per-connection basis to limit resource consumption. The hard limits are set using the `SQLITE_MAX_XXX` build options. If an application attempts to set the limit value higher than the hard limit, the limit will be silently set to the maximum limit.

For a full list of the currently supported limits, see [http://www.sqlite.org/c3ref/c\\_limit\\_attached.html](http://www.sqlite.org/c3ref/c_limit_attached.html).

### See Also

[sqlite3\\_config\(\)](#), [sqlite3\\_db\\_config\(\)](#)

---

## sqlite3\_load\_extension()

Load a dynamic extension

### Definition

```
int sqlite3_load_extension( sqlite3* db,
                           const char* file, const char* entry_point, char** errmsg );
```

db

A database connection.

file

The path and filename of the extension.

entry\_point

The name of the entry-point function. If this is NULL, the name `sqlite3_extension_init` will be used.

errmsg

An optional reference to a string pointer. If the function returns anything other than `SQLITE_OK`, and error message will be passed back. If no error is encountered, the pointer will be set to NULL. The reference may be NULL to ignore error messages. Error messages must be freed with `sqlite3_free()`.

Returns

An SQLite result code.

### Description

This function attempts to load an SQLite dynamic extension. By default, the use of dynamic extensions are disabled, and must be enabled using the `sqlite3_enable_load_extension()` call.

This function is also exposed as the `load_extension()` SQL function.

Although there are no limits on when an extension may be loaded, many extensions register new functions and are thus subject to the limits of `sqlite3_create_function()`.

For more information on dynamic extensions, please see the section “[Using Loadable Extensions](#)” on page 211.

### See Also

[sqlite3\\_enable\\_load\\_extension\(\)](#) [C API, Ap G], [sqlite3\\_create\\_function\(\)](#) [C API, Ap G], [load\\_extension\(\)](#) [SQL Func, Ap E]

---

## sqlite3\_log()

Log a message in the SQLite logfile [EXP]

### Definition

```
void sqlite3_log( int errcode, const char* format, ... );
```

#### errcode

The error code associated with this log message.

#### format

A `sqlite3_snprintf()` style message formatting string.

#### Additional parameters

Message formatting parameters.

### Description

This function logs a message in the SQLite logfile. The format and additional parameters will be passed to an `sqlite3_snprintf()` like function for formatting. Messages are limited to a few hundred characters. Longer messages will be truncated.

The `sqlite3_log()` function was designed to be used by extensions that do not have a normal debug or error reporting path. Normally, SQLite has no logfile and the message is simply ignored. A logfile may be configured using `sqlite3_config()`.

### See Also

[sqlite3\\_config\(\)](#)

---

## sqlite3\_malloc()

Obtain a dynamic memory allocation

### Definition

```
void* sqlite3_malloc( int bytes );
```

#### bytes

The size of the requested allocation, in bytes.

#### Returns

A newly allocated buffer. If the memory is not available, NULL is returned.

### Description

This function obtains a dynamic memory allocation from the SQLite library. Memory allocated with `sqlite3_malloc()` should be released with `sqlite3_free()`. Allocations will always start on an 8-byte (or larger) boundary.

Although many SQLite environments will simply pass memory allocation requests on to the default system memory allocator, there are some environments that configure specific buffers for the SQLite library. By using these memory handling functions, an SQLite extension or module will work correctly in any SQLite environment, regardless of how the memory allocator is configured.

### See Also

[sqlite3\\_free\(\)](#), [sqlite3\\_realloc\(\)](#)

---

**sqlite3\_memory\_highwater()**

Get or reset the memory usage high-water mark

**Definition**

```
sqlite3_int64 sqlite3_memory_highwater( int reset );
```

**reset**

If this value is nonzero, the high-water mark will be reset to the current in-use value.

**Returns**

The high-water mark of bytes allocated by the SQLite memory system.

**Description**

This function returns the memory usage high-water mark, or the highest seen value. The high-water mark can optionally be reset to the current value.

**See Also**

[sqlite3\\_memory\\_used\(\)](#)

---

**sqlite3\_memory\_used()**

Get the current memory use

**Definition**

```
sqlite3_int64 sqlite3_memory_used( );
```

**Returns**

The number of bytes currently allocated by the SQLite memory system.

**Description**

This function returns the current number of bytes allocated by the SQLite memory functions. This figure includes all of the overhead introduced by the SQLite allocator, but does not include any overhead required by the system memory handlers.

**See Also**

[sqlite3\\_memory\\_highwater\(\)](#), [sqlite3\\_malloc\(\)](#)

---

**sqlite3\_mprintf()**

Format and allocate a string

**Definition**

```
char* sqlite3_mprintf( const char* format, ... );
```

**format**

An [sqlite3\\_snprintf\(\)](#) style message formatting string.

**Additional parameters**

Message formatting parameters.

**Returns**

A newly allocated string built from the given parameters.

sqlite3\_mutex\_alloc()

## Description

This function builds a formatted string and returns it in a newly allocated memory buffer. If the required memory allocation fails, a NULL may be returned. The application is responsible for releasing the returned buffer with `sqlite3_free()`.

This function supports the same extended formatting options as `sqlite3_snprintf()`.

## See Also

[sqlite3\\_snprintf\(\)](#)

---

## sqlite3\_mutex\_alloc()

Allocate a new mutex lock

### Definition

```
sqlite3_mutex* sqlite3_mutex_alloc( int type );
```

type

The desired type of mutual exclusion lock.

*Returns*

A newly allocated and initialized mutual exclusion lock.

### Description

This function allocates and initializes a new mutual exclusion lock of the requested type. Applications can request an `SQLITE_MUTEX_RECURSIVE` or `SQLITE_MUTEX_FAST` lock. A recursive lock must support and properly reference-count multiple enter/leave calls by the same thread. A fast mutex does not need to support anything other than simple enter/leave semantics. Depending on the threading library, a fast lock may not actually be any faster than a recursive lock.

Any application mutex acquired through `sqlite3_mutex_alloc()` should eventually be freed with `sqlite3_mutex_free()`.

## See Also

[sqlite3\\_mutex\\_free\(\)](#), [sqlite3\\_db\\_mutex\(\)](#)

---

## sqlite3\_mutex\_enter()

Acquire a mutex lock

### Definition

```
void sqlite3_mutex_enter( sqlite3_mutex* mutex );
```

mutex

A mutual exclusion lock. If a NULL value is passed, the function will return immediately.

### Description

This function attempts to have the calling thread acquire a mutual exclusion lock. This is typically done when entering a critical section of code. The function (and thread) will block until access to the lock is granted.



Like most of the other mutex functions, this function is designed to replicate the default success behavior when given a NULL mutex. This allows the result of `sqlite3_db_mutex()` to be passed directly to `sqlite3_mutex_enter()` (or most other mutex functions) without having to test the current threading mode.

### See Also

[sqlite3\\_mutex\\_leave\(\)](#), [sqlite3\\_mutex\\_try\(\)](#), [sqlite3\\_db\\_mutex\(\)](#)

## sqlite3\_mutex\_free()

Deallocate a mutex lock

### Definition

```
void sqlite3_mutex_free( sqlite3_mutex* mutex );
```

mutex

A mutual exclusion lock. Passing in a NULL pointer are not allowed.

### Description

This function destroys and deallocates a mutual exclusion lock. The lock should not be held by any thread when it is freed. Applications should only free locks that the application created with `sqlite3_mutex_alloc()`.

### See Also

[sqlite3\\_mutex\\_alloc\(\)](#)

## sqlite3\_mutex\_held()

Test if a mutex lock is held

### Definition

```
int sqlite3_mutex_held( sqlite3_mutex* mutex );
```

mutex

A mutual exclusion lock. If a NULL value is passed, the function should return true (nonzero).

### Returns

A nonzero value if the given mutex is currently held, or a zero value if the mutex is not held.

### Description

This function tests to see if the current thread holds the given mutual exclusion lock. The SQLite library only uses this function in `assert()` checks. Generally, this function is only available if SQLite is compiled while `SQLITE_DEBUG` is defined. Not all threading libraries supports this function. Unsupported platforms should always return true (nonzero).

Applications should limit use of this function to debug and verification code.

### See Also

[sqlite3\\_mutex\\_notheld\(\)](#), [sqlite3\\_mutex\\_enter\(\)](#), `SQLITE_DEBUG` [Build Opt, Ap A]

---

## sqlite3\_mutex\_leave()

Release a mutex lock

### Definition

```
void sqlite3_mutex_leave( sqlite3_mutex* mutex );
```

mutex

A mutual exclusion lock. If a NULL value is passed, the function will simply return.

### Description

This function allows a thread to release its hold on a mutual exclusion lock. This makes the lock available to other threads. This is typically done when leaving a critical section of code.

### See Also

[sqlite3\\_mutex\\_enter\(\)](#), [sqlite3\\_mutex\\_alloc\(\)](#), [sqlite3\\_db\\_mutex\(\)](#), [sqlite3\\_mutex\\_free\(\)](#)

---

## sqlite3\_mutex\_notheld()

Test if a mutex lock is not held

### Definition

```
int sqlite3_mutex_notheld( sqlite3_mutex* mutex );
```

mutex

A mutual exclusion lock. If a NULL value is passed, the function should return true (nonzero).

### Returns

A nonzero value if the given mutex is currently *not* held, or a zero value if the mutex *is* held.

### Description

This function is essentially the opposite of [sqlite3\\_mutex\\_held\(\)](#) and is subject to the same conditions and limitations.

### See Also

[sqlite3\\_mutex\\_held\(\)](#)

---

## sqlite3\_mutex\_try()

Attempt to acquire a mutex lock

### Definition

```
int sqlite3_mutex_try( sqlite3_mutex* mutex );
```

mutex

A mutual exclusion lock.

### Returns

The value `SQLITE_OK` is returned if the lock was acquired. Otherwise, `SQLITE_BUSY` will be returned.

## Description

This function attempts to acquire a mutual exclusion lock for the current thread. If the lock is acquired, `SQLITE_OK` will be returned. If the lock is held by another thread, `SQLITE_BUSY` will be returned. If a `NULL` mutex pointer is passed in, the function will return `SQLITE_OK`.

This function is not supported by all threading libraries. If SQLite has thread support, but this function is not supported, a valid mutex will always result in an `SQLITE_BUSY` return code.

## See Also

[sqlite3\\_mutex\\_enter\(\)](#), [sqlite3\\_mutex\\_leave\(\)](#)

## sqlite3\_next\_stmt()

Step through a list of prepared statements

### Definition

```
sqlite3_stmt* sqlite3_next_stmt( sqlite3* db, sqlite3_stmt* stmt );
```

`db`

A database connection.

`stmt`

The previous statement. To get the first statement, pass in a `NULL`.

*Returns*

A prepared statement pointer. A `NULL` indicates the end of the list.

### Description

This function iterates over the list of prepared statements associated with the given database connection. Passing in a `NULL` statement pointer will return the first statement. Subsequent statements can be retrieved by passing back the last returned statement value.

If an application is iterating over prepared statements and finalizing them, remember that the `sqlite3_finalize()` function will remove the statement from the statement list. In such cases, the application should keep passing in a `NULL` statement value until no more statements remain. This technique is not recommended, however, as it can leave dangling statement pointers.

### See Also

[sqlite3\\_prepare\\_xxx\(\)](#), [sqlite3\\_finalize\(\)](#)

## sqlite3\_open()

Open a database file

### Definition

```
int sqlite3_open( const char* filename, sqlite3** db_ref );
int sqlite3_open16( const void* filename, sqlite3** db_ref );
```

`filename`

The path and filename of the database file as a UTF-8 or UTF-16 encoded string.

sqlite3\_open\_v2()

db\_ref

A reference to a database connection. If the database is successfully opened, the database connection will be passed back.

Returns

An SQLite result code.

## Description

These functions open a database and create a new database connection. If the filename does not exist, it will be created. The file will be opened read/write if possible. If not, the file will be opened read-only.

If the filename is `:memory:`, a temporary, in-memory database will be created. The database will automatically be deleted when the database connection is closed. Each call to open will create a new in-memory database. Each in-memory database is accessible from only one database connection.

If the filename is NULL or an empty string (`""`), a temporary, file-backed database will be created. This is very similar to an in-memory database, only the database is allowed to page out to disk. This allows the database to grow to much larger sizes without worrying about memory consumption.

These functions are considered legacy APIs. It is recommended that all new development use `sqlite3_open_v2()`.

## See Also

[sqlite3\\_open\\_v2\(\)](#), [sqlite3\\_close\(\)](#)

---

## sqlite3\_open\_v2()

Open a database file

### Definition

```
int sqlite3_open_v2( const char* filename, sqlite3** db_ref,  
                    int flags, const char* vfs );
```

filename

The path and filename of the database file as a UTF-8 encoded string.

db\_ref

A reference to a database connection. If the database is successfully opened, the database connection will be passed back.

flags

A series of flags that can be used to control how the database file is open.

vfs

The name of the VFS (Virtual File System) module to use. A NULL will result in the default module.

*Returns*

An SQLite result code.

**Description**

This function is very similar to `sqlite3_open()`, but provides better control over how the database file is opened. The `flags` parameter controls the state of the opened file, while the `vfs` parameter allows the application to specify a VFS (virtual file system) driver.

The flag parameter consists of several bit-flags that can be or'ed together. The application must specify one of the following flag combinations:

**SQLITE\_OPEN\_READONLY**

Open the file read-only. The file must already exist.

**SQLITE\_OPEN\_READWRITE**

Attempt to open the file read/write. If this is not possible, open the file read-only. Opening the file read-only will not result in an error. The file must already exist.

**SQLITE\_OPEN\_READWRITE | SQLITE\_OPEN\_CREATE**

Attempt to open the file read/write. If it does not exist, create the file. If the file does exist, but permissions do not allow read/write access, open the file read-only. Opening the file read-only will not result in an error. This is the behavior of `sqlite3_open()`.

Additionally, these optional flags may be added to one of the above flag sets:

**SQLITE\_OPEN\_NOMUTEX**

If the SQLite library was compiled with threading support, open the database connection in “multithread” mode. This flag cannot be used in conjunction with the `SQLITE_OPEN_FULLMUTEX` flag.

**SQLITE\_OPEN\_FULLMUTEX**

If the SQLite library was compiled with threading support, open the database connection in “serialized” mode. This flag cannot be used in conjunction with the `SQLITE_OPEN_NO_MUTEX` flag.

**SQLITE\_OPEN\_SHARED\_CACHE**

Enables shared cache mode for this database connection. This flag cannot be used in conjunction with the `SQLITE_OPEN_PRIVATECACHE` flag.

**SQLITE\_OPEN\_PRIVATECACHE**

Disables shared cache mode for this database connection. This flag cannot be used in conjunction with the `SQLITE_OPEN_SHARED_CACHE` flag.

Additional flags may be added to future versions of SQLite.

**See Also**

[sqlite3\\_open\(\)](#) [Ap G], [sqlite3\\_close\(\)](#) [Ap G], [sqlite3\\_enable\\_shared\\_cache\(\)](#) [Ap G], [sqlite3\\_config\(\)](#) [Ap G], [sqlite3\\_vfs\\_find\(\)](#) [Ap G]

---

## sqlite3\_overload\_function()

Create a stub function [EXP]

### Definition

```
int sqlite3_overload_function( sqlite3* db, const char* name, int num_param );
```

**db**

A database connection.

**name**

A function name, in UTF-8.

**num\_param**

The number of parameters in the stub function.

*Returns*

An SQLite result code.

### Description

This function checks to see if the named SQL function (with the specified number of parameters) exists or not. If the function does exist, nothing is done. If the function does not already exist, a stub function is registered. This stub function will always return `SQLITE_ERROR`.

This function exists to support virtual table modules. Virtual tables have the ability to override functions that use virtual table columns as parameters. In order to do this, the function must already exist. The virtual table could register a stub function by itself, but this risks overriding an existing function. This function ensures there is a base SQL function that can be overridden without accidentally redefining an application-defined function.

### See Also

[sqlite3\\_create\\_function\(\)](#), [sqlite3\\_create\\_module\(\)](#)

---

## sqlite3\_prepare\_xxx()

Convert an SQL string into a prepared statement

### Definition

```
int sqlite3_prepare(      sqlite3* db, const char* sql, int sql_len,
                        sqlite3_stmt** stmt_ref, const char** tail );
int sqlite3_prepare16(   sqlite3* db, const void* sql, int sql_len,
                        sqlite3_stmt** stmt_ref, const char** tail );
int sqlite3_prepare_v2(  sqlite3* db, const char* sql, int sql_len,
                        sqlite3_stmt** stmt_ref, const char** tail );
int sqlite3_prepare16_v2( sqlite3* db, const void* sql, int sql_len,
                        sqlite3_stmt** stmt_ref, const char** tail );
```

**db**

A database connection.

**sql**

One or more SQL statements in a UTF-8 or UTF-16 encoded string. If the string contains more than one SQL statement, the statements must be separated by a semicolon. If the string contains only one SQL statement, no trailing semicolon is required.

**sql\_len**

The length of the `sql` buffer in bytes. If the `sql` string is null-terminated, the length should include the termination character. If the `sql` string is null-terminated but the length is not known, a negative value will cause SQLite to compute the buffer length.

**stmt\_ref**

A reference to a prepared statement. SQLite will allocate and pass back the prepared statement.

**tail**

If the `sql` buffer contains more than one SQL statement, only the first complete statement is used. If additional statements exist, this reference will be used to pass back a pointer to the next SQL statement in the `sql` buffer. This reference may be set to NULL.

**Returns**

An SQLite result code.

**Description**

These functions take an SQL statement string and build a prepared statement. The prepared statement can be executed using `sqlite3_step()`. All prepared statements must eventually be finalized with `sqlite3_finalize()`.

Both the original and the `_v2` versions of `prepare` take the exact same parameters. The `_v2` versions produce a slightly different statement, however. The newer statements are able to automatically recover from some errors and provide better error handling. For a more in-depth discussion of the differences, see [“Prepare v2” on page 149](#).

The original versions are considered legacy APIs, and their use in new development is not recommended.

**See Also**

[sqlite3\\_finalize\(\)](#), [sqlite3\\_step\(\)](#)

---

**sqlite3\_profile()**

Register an SQL statement profile callback

**Definition**

```
void* sqlite3_profile( sqlite3* db, profile_func, void* udp );
void profile_func( void* udp, const char* sql, sqlite3_uint64 time );
```

**db**

A database connection.

**profile\_func**

An application-defined profile callback function.

**udp**

An application-defined user-data pointer. This value is made available to the profile function.

`sqlite3_progress_handler()`

`sql`

The text of the SQL statement that was executed, encoded in UTF-8.

`time`

The wall-clock time required to execute the statement, in nanoseconds. Most system clocks cannot actually provide nanosecond precision.

*Returns* (`sqlite3_profile()`)

The `udp` parameter of any prior profile function. If no prior profile function was registered, a NULL will be returned.

## Description

This function allows an application to register a profiling function. The callback function is called every time a call to `sqlite3_step()` finishes. Only one profile function is allowed. Registering a new function will override the old function. To unregister a profiling function, pass in a NULL function pointer.

## See Also

[sqlite3\\_trace\(\)](#), [sqlite3\\_prepare\\_xxx\(\)](#), [sqlite3\\_step\(\)](#)

---

## `sqlite3_progress_handler()`

Register a progress handler

### Definition

```
void sqlite3_progress_handler( sqlite3* db, int num_ops,  
                             progress_handler, void* udp );
```

```
int progress_handler( void* udp );
```

`db`

A database connection.

`num_ops`

The number of byte-code operations the database engine should perform between calls to the progress handler. This is an approximation.

`progress_handler`

An application-defined progress handler callback function.

`udp`

An application-defined user-data pointer. This value is made available to the progress handler.

*Returns* (`progress_handler()`)

If the handler returns a nonzero value, the current database operations are interrupted.

## Description

This function allows an application to register a progress handler callback. Any time the database connection is in use, the progress handler will be called. The frequency is controlled by the `num_ops` parameter, which is the approximate number of virtual database engine byte-code operations that will be performed between each call.



This function only provides a periodic callback. It cannot be used to estimate the percentage of completion.

### See Also

[sqlite3\\_interrupt\(\)](#)

## sqlite3\_randomness()

Request random value data

### Definition

```
void sqlite3_randomness( int bytes, void* buffer );
```

*bytes*

The desired number of random data bytes.

*buffer*

An application buffer that is large enough to hold the requested data.

### Description

This function allows an application to request random data values from SQLite's internal pseudo-random number generator.

### See Also

[random\(\)](#) [SQL Func, Ap E], [randomblob\(\)](#) [SQL Func, Ap E]

## sqlite3\_realloc()

Resize a dynamic memory allocation

### Definition

```
void* sqlite3_realloc( void* ptr, int bytes );
```

*ptr*

A pointer to an existing dynamic memory buffer. May be NULL.

*bytes*

The new size of the requested buffer, in bytes.

### Returns

The newly adjusted buffer. May be NULL if unable to allocate memory. If NULL, the old buffer will still be valid.

### Description

This function resizes a dynamic memory allocation. It can be used to increase or decrease the size of an allocation. This may require moving the allocation. In that case, the contents of the current buffer will be copied to the beginning of the adjusted buffer. If the new buffer is smaller, some data will be dropped. Allocations will always start on an 8-byte (or larger) boundary.

`sqlite3_release_memory()`

If a NULL pointer is passed in, this function will act like `sqlite3_malloc()` and allocate a new buffer. If the bytes parameter is zero or negative, this function will act like `sqlite3_free()`, releasing the existing buffer and returning NULL.

### See Also

[sqlite3\\_malloc\(\)](#), [sqlite3\\_free\(\)](#)

---

## sqlite3\_release\_memory()

Reduce memory usage

### Definition

```
int sqlite3_release_memory( int bytes );
```

bytes

The requested number of bytes to free.

*Returns*

The actual number of bytes to free. This may be more or less than the requested number.

### Description

This function requests that the SQLite library free a specific amount of memory. SQLite will do this by deallocating noncritical memory, such as cache space (this includes the page cache). The memory that is freed may not be contiguous.

### See Also

[sqlite3\\_malloc\(\)](#), [sqlite3\\_free\(\)](#)

---

## sqlite3\_reset()

Reset of prepared statement

### Definition

```
int sqlite3_reset( sqlite3_stmt* stmt );
```

stmt

A prepared statement.

*Returns*

An SQLite result code.

### Description

This function resets a prepared statement, making it available for execution. This is typically done after one or more calls to `sqlite3_step()`. The reset call will release any locks and other resources associated with the last execution of the statement. This function may be called any time between calls to `sqlite3_prepare_xxx()` and `sqlite3_finalize()`.

This function does not clear the statement parameter bindings. An application must call `sqlite3_clear_bindings()` to reset the statement parameters to NULL.

### See Also

[sqlite3\\_prepare\\_xxx\(\)](#), [sqlite3\\_step\(\)](#), [sqlite3\\_finalize\(\)](#), [sqlite3\\_clear\\_bindings\(\)](#)

---

**sqlite3\_reset\_auto\_extension()**

Remove all automatic extensions

**Definition**

```
void sqlite3_reset_auto_extension( );
```

**Description**

This function removes all automatic extensions that were previously registered with `sqlite3_auto_extension()`.

There is no way to remove specific extensions or to retrieve a list of the current extensions.

**See Also**

[sqlite3\\_auto\\_extension\(\)](#)

---

**sqlite3\_result\_xxx()**

Return an result from an SQL function

**Definition**

```
void sqlite3_result_blob(    sqlite3_context* ctx, const void* val,
                           int bytes, mem_callback )
void sqlite3_result_double( sqlite3_context* ctx, double val );
void sqlite3_result_int(   sqlite3_context* ctx, int val );
void sqlite3_result_int64( sqlite3_context* ctx, sqlite3_int64 val );
void sqlite3_result_null(  sqlite3_context* ctx );
void sqlite3_result_text(  sqlite3_context* ctx, const char* val,
                           int bytes, mem_callback )
void sqlite3_result_text16( sqlite3_context* ctx, const void* val,
                             int bytes, mem_callback )
void sqlite3_result_text16le( sqlite3_context* ctx, const void* val,
                               int bytes, mem_callback )
void sqlite3_result_text16be( sqlite3_context* ctx, const void* val,
                               int bytes, mem_callback )
void sqlite3_result_value(  sqlite3_context* ctx, sqlite3_value* val );
void sqlite3_result_zeroblob( sqlite3_context* ctx, int bytes );

void mem_callback( void* ptr );
```

**ctx**

An SQL function context, provided by the SQLite library.

**val**

Data value to return.

**bytes**

The size of the data value, in bytes. In specific, text values are in bytes, not characters.

**mem\_callback**

A function pointer to a memory deallocation function. This function is used to free the memory buffer used to hold the value. If the buffer was allocated with `sqlite3_malloc()`, a reference to `sqlite3_free()` can be passed directly.

`sqlite3_result_error_xxx()`

The special flags `SQLITE_STATIC` and `SQLITE_TRANSIENT` can also be used. `SQLITE_STATIC` indicates that the application will keep value memory valid. `SQLITE_TRANSIENT` will cause SQLite to make an internal copy of the value buffer that will be automatically freed when it is no longer needed.

## Description

These functions return a result from an SQL function implementation. A scalar function and an aggregate finalize function may return a result. An aggregate step function may only return an error with `sqlite3_result_error_xxx()`. The default return value will be an SQL NULL unless one of these functions is used. A function may call one of these functions (and/or calls to `sqlite3_result_error_xxx()`) as many times as needed to update or reset the result value.

In most other regards, these functions are nearly identical to the `sqlite3_bind_xxx()` functions.

## See Also

[sqlite3\\_result\\_error\\_xxx\(\)](#), [sqlite3\\_create\\_function\(\)](#)

---

## `sqlite3_result_error_xxx()`

Return an error condition from an SQL function

### Definition

```
void sqlite3_result_error(      sqlite3_context* ctx,
                               const char* msg, int bytes );
void sqlite3_result_error16(   sqlite3_context* ctx,
                               const void* msg, int bytes );
void sqlite3_result_error_code( sqlite3_context* ctx, int errcode );
void sqlite3_result_error_nomem( sqlite3_context* ctx );
void sqlite3_result_error_toobig( sqlite3_context* ctx );
```

`ctx`

An SQL function context, provided by the SQLite library.

`msg`

The error message to return, in UTF-8 or UTF-16 encoding.

`bytes`

The size of the error message, in bytes (not characters).

`errcode`

An SQLite result code.

### Description

These functions return an error from an SQL function implementation. This will cause an SQL exception to be thrown and `sqlite3_step()` to return the given error. A function may call one of these functions (and calls to `sqlite3_result_xxx()`) as many times as needed to update or reset the result error.

The functions `sqlite3_result_error()` and `sqlite3_result_error16()` will set the result error to `SQLITE_ERROR` and pass back the provided error message. A copy is made of the error message, so there is no need to keep the message buffer valid after the function returns.

The function `sqlite3_result_error_code()` sets an SQLite result code other than `SQLITE_ERROR`. Because `sqlite3_result_error[16]()` sets the result code to `SQLITE_ERROR`, passing back both a custom message and error code requires setting the message, followed by the result code.

The function `sqlite3_result_error_nomem()` indicates an out-of-memory condition. This specialized function will not attempt to allocate memory. The function `sqlite3_result_error_toobig()` indicates that an input parameter (typically a text or BLOB value) was too large for an application to process.

### See Also

[sqlite3\\_result\\_xxx\(\)](#), [sqlite3\\_create\\_function\(\)](#)

---

## sqlite3\_rollback\_hook()

Register a rollback callback

### Definition

```
void* sqlite3_rollback_hook( sqlite3* db, rollback_callback, void* udp );

void commit_callback( void* udp );
```

**db**

A database connection.

**rollback\_callback**

Function pointer to an application-defined commit callback function.

**udp**

An application-defined user-data pointer. This value is made available to the rollback callback.

*Returns* (`sqlite3_rollback_hook()`)

The previous user-data pointer, if applicable.

### Description

This function registers a rollback callback. This callback function is called when the database performs a rollback from an explicit `ROLLBACK`, or due to an error condition (including a commit callback returning nonzero). The callback is not called when an in-flight transaction is rolled back due to the database connection being closed.

Each database connection can have only one callback. Registering a new callback will overwrite any previously registered callback. To remove the callback, set a NULL function pointer.

The callback must not use the associated database connection to modify any databases, nor may it call `sqlite3_prepare_v2()` or `sqlite3_step()`.

### See Also

[sqlite3\\_commit\\_hook\(\)](#), [sqlite3\\_update\\_hook\(\)](#)

---

## sqlite3\_set\_authorizer()

### Definition

```
int sqlite3_set_authorizer( sqlite3* db, auth_callback, void* udp );

int auth_callback( void* udp, int action_code,
                  const char* param1, const char* param2,
                  const char* db_name, const char* trigger_name );
```

**db**

A database connection.

**auth\_callback**

An application-defined authorization callback function.

**udp**

An application-defined user-data pointer. This value is made available to the authorization callback.

**action\_code**

A code indicating which database operation requires authorization.

**param1, param2**

Two data values related to the authorization action. The specific meaning of these parameters depends on the value of the **action\_code** parameter.

**db\_name**

The logical name of the database being affected by the action in question. This value is valid for many, but not all, **action\_code** values.

**trigger\_name**

If the action in question comes from a trigger, the name of the lowest-level trigger. If the action comes from a bare SQL statement, this parameter will be NULL.

*Returns* (sqlite3\_set\_authorizer())

An SQLite result code.

*Returns* (auth\_func())

An SQLite result code. The code `SQLITE_OK` indicates that the action is allowed. The code `SQLITE_IGNORE` denies the specific action, but allows the SQL statement to continue. The code `SQLITE_DENY` causes the whole SQL statement to be rejected.

### Description

This function registers an authorization callback. The callback is called when SQL statements are prepared, allowing the application to allow or deny specific actions. This is useful when processing SQL statements from external sources (including the application user). The authorization function must not utilize the database connection.

For a full description of the currently supported action codes, see [http://www.sqlite.org/c3ref/c\\_alter\\_table.html](http://www.sqlite.org/c3ref/c_alter_table.html).

**See Also**

[sqlite3\\_prepare\\_xxx\(\)](#), [sqlite3\\_limit\(\)](#)

**sqlite3\_set\_auxdata()**

Set auxiliary data on a function parameter

**Definition**

```
void sqlite3_set_auxdata( sqlite3_context* ctx, int pidx,
                        void* data, mem_callback );
```

```
void mem_callback( void* ptr );
```

*ctx*

An SQL function context, provided by the SQLite library.

*pidx*

The parameter index.

*data*

The auxiliary data value.

*mem\_callback*

A function pointer to a memory deallocation function. This function frees the memory buffer used to hold the value. If the buffer was allocated with `sqlite3_malloc()`, a reference to `sqlite3_free()` can be passed directly.

The flags `SQLITE_STATIC` and `SQLITE_TRANSIENT` (which are used by `sqlite3_bind_xxx()` and `sqlite3_result_xxx()`) are not available in this context.

**Description**

This function allows an SQL function implementation to attach auxiliary data to specific SQL function parameters. In situations where an SQL statement calls the same function repeatedly with the same parameter values, the auxiliary data will be preserved across calls. This allows a function implementation to cache high-cost value, such as a compiled regular expression.

For more details on how to use auxiliary data, see [http://www.sqlite.org/c3ref/get\\_auxdata.html](http://www.sqlite.org/c3ref/get_auxdata.html).

**See Also**

[sqlite3\\_get\\_auxdata\(\)](#), [sqlite3\\_create\\_function\(\)](#)

**sqlite3\_shutdown()**

Shut down the SQLite library

**Definition**

```
int sqlite3_shutdown( );
```

*Returns*

An SQLite result code.

sqlite3\_sleep()

## Description

This function shuts down the SQLite library and releases all associated resources. The library must be reinitialized before it can be used again. It is safe to call this function multiple times.

## See Also

[sqlite3\\_initialize\(\)](#)

---

## sqlite3\_sleep()

Sleep the current thread

### Definition

```
int sqlite3_sleep( int milliseconds );
```

*milliseconds*

The number of wall-clock milliseconds to sleep. Not all platforms support this time resolution. The number may be rounded up.

*Returns*

The number of milliseconds actually slept.

### Description

This function puts the current thread to sleep for at least the specified number of milliseconds (thousandths of a second). The actual sleep time may be longer, especially on those systems that do not support millisecond process clocks.

---

## sqlite3\_snprintf()

Format a string

### Definition

```
char* sqlite3_snprintf( int bytes, char* buf, const char* format, ... );
```

*bytes*

The number of bytes available in the output buffer.

*buf*

A pre-allocated buffer to receive the formatted string.

*format*

The format string used to build the output string. This is similar to the standard `printf()` style formatted string, but it supports a few extra formatting flags.

*Additional parameters*

Message formatting parameters.

*Returns*

A pointer to the formatted string buffer.



## Description

This function formats and builds a UTF-8 string in the provided buffer. It is designed to mimic the standard `snprintf()` function. Assuming the provided buffer is one byte or larger, the string will always be null-terminated.

Note that the first two parameters of `sqlite3_snprintf()` are reversed from the standard `snprintf()`. Also, `snprintf()` returns the number of characters in the output string, while `sqlite3_snprintf()` returns a pointer to the buffer passed in by the application.

In addition to the standard `%s`, `%c`, `%d`, `%i`, `%o`, `%u`, `%x`, `%X`, `%f`, `%e`, `%E`, `%g`, `%G`, and `%%` formatting flags, all SQLite `printf()` style functions also support the `%q`, `%Q`, `%z`, `%w`, and `%p` flags.

The `%q` flag is similar to `%s`, only it will sanitize the string for use as an SQL string literal. Mostly, this consists of doubling all the single quote characters (`'`) to form a proper SQL escape (`'`). Thus, `%q` will take the input string `0'Reilly` and output `0''Reilly`. The formatted string should contain enclosing single quotes (e.g., `"... '%q' ..."`).

The `%Q` flag is similar to `%q`, only it will wrap the input string in single quotes as well. The `%Q` flag will take the input string `0'Reilly` and output `'0''Reilly'` (including the enclosing single quotes). The `%Q` flag will also output the constant `NULL` (without single quotes) if the string value is a `NULL` pointer. This allows the `%Q` flag to accept a more diverse set of character pointers without additional application logic. Because the `%Q` includes its own, the formatted string should contain enclosing single quotes (e.g., `"... %Q ..."`).

The `%w` flag is similar to the `%q` flag, only it is designed to work on SQL identifiers, rather than SQL string constants. Identifiers include database names, table names, and column names. The `%w` flag will sanitize input values by doubling all the double quote characters (`"`) to form a proper SQL escape (`"`). Similar to `%q`, the formatted string that uses `%w` should include enclosing quotes. In the case of identifiers, they should be double quotes:

```
"... \"%w\" ..."
```

Finally, the `%p` flag is designed to format pointers. This will produce a hexadecimal value, and should work correctly on both 32- and 64-bit systems.

Generally, building SQL queries using string manipulations is somewhat risky. For literal values, it is better to use the `prepare/bind/step` interface, even if the statement will only be used once. If you must build a query string, always make sure to properly sanitize your input values using `%q`, `%Q`, or `%w`, and always be sure values are properly quoted. That includes putting double quotes around all identifiers and names.

## See Also

[sqlite3\\_mprintf\(\)](#), [sqlite3\\_vmprintf\(\)](#)

---

## sqlite3\_soft\_heap\_limit()

Limit the memory used by SQLite

### Definition

```
void sqlite3_soft_heap_limit( int bytes );
```

bytes

The requested limit, in bytes.

### Description

This function sets a soft limit on the amount of dynamic heap memory used by the SQLite library. If a memory allocation would cause the limit to be exceeded, `sqlite3_release_memory()` is called in an attempt to recover memory. If this is not successful, the memory is allocated anyway, without warning or error.

To remove the limit, simply pass in a zero or negative value.

### See Also

[sqlite3\\_release\\_memory\(\)](#), [sqlite3\\_limit\(\)](#), [sqlite3\\_config\(\)](#), [sqlite3\\_db\\_config\(\)](#)

---

## sqlite3\_sourceid()

Get the SQLite library source-identifier

### Definition

```
const char* sqlite3_sourceid( );
```

Returns

The source-identifier value for the check-in used to build the SQLite library.

### Description

This function returns the source-identifier of the SQLite library. The source-identifier consists of the date, time, and hash code from the final source control check-in used to build the SQLite library. The source-identifier for SQLite 3.6.23.1 is:

```
2010-03-26 22:28:06 b078b588d617e07886ad156e9f54ade6d823568e
```

This value is also available at compile time as the `SQLITE_SOURCE_ID` macro. By comparing the macro used at compile time to the value returned at runtime, an application can verify that it is linking against the correct version of the library.

This function is exposed to the SQL environment as the SQL function `sqlite_source_id()`.

### See Also

[sqlite3\\_libversion\(\)](#), [sqlite3\\_libversion\\_number\(\)](#), [sqlite\\_source\\_id\(\)](#) [SQL Func, Ap E]

---

## sqlite3\_sql()

Get the SQL of a prepared statement

### Definition

```
const char* sqlite3_sql( sqlite3_stmt stmt );
```

stmt

A prepared statement.

*Returns*

The SQL string used to prepare a statement.

### Description

This function returns the original SQL string used to prepare the given statement. The statement must have been prepared with a `_v2` version of `prepare`. If the statement was prepared with the original `sqlite3_prepare()` or `sqlite3_prepare16()` functions, this function will always return `NULL`.

The returned statement will always be encoded in UTF-8, even if `sqlite3_prepare16_v2()` was used to prepare the statement.

### See Also

[sqlite3\\_prepare\\_xxx\(\)](#)

## sqlite3\_status()

Get the status of an SQLite library resource [EXP]

### Definition

```
int sqlite3_status( int option, int *current, int *highest, int reset );
```

option

The status option to retrieve.

current

A reference to an integer. The current value will be passed back using this reference.

highest

A reference to an integer. The highest seen value will be passed back using this reference.

reset

If this flag is nonzero, the high-water mark will be reset to the current value after the current high-water mark value is returned.

*Returns*

An SQLite result code.

### Description

This function retrieves status information from the SQLite library. When an application requests a specific status option, both the current and the highest seen value are passed back. The application can optionally reset the highest seen value to the current value.

The available options include several different memory monitors, as well as information on the page cache. For a full list of the currently supported options, see [http://www.sqlite.org/c3ref/c\\_status\\_malloc\\_size.html](http://www.sqlite.org/c3ref/c_status_malloc_size.html).

### See Also

[sqlite3\\_db\\_status\(\)](#), [sqlite3\\_memory\\_highwater\(\)](#)

---

## sqlite3\_step()

Execute a prepared statement

### Definition

```
int sqlite3_step( sqlite3_stmt* stmt );
```

stmt

A prepared statement.

### Returns

An SQLite status code. If a result row is available, `SQLITE_ROW` will be returned. When the statement is done executing, `SQLITE_DONE` is returned. Any other value should be considered some type of error.

### Description

This function executes a prepared statement. The function will return `SQLITE_DONE` when the statement has finished executing. At that point, the statement must be reset before `sqlite3_step()` can be called again. If the prepared statement returns any type of value, `SQLITE_ROW` will be returned. This indicates a row of data values are available. The application can extract these values using the `sqlite3_column_xxx()` functions. The application can continue to call `sqlite3_step()` until it returns `SQLITE_DONE`. This function should never return `SQLITE_OK`.

Many SQL commands, such as `CREATE TABLE`, never return any SQL values. Most other SQL commands, such as `INSERT`, `UPDATE`, and `DELETE`, do not return any SQL values by default. All of these SQL commands will typically perform their action and return `SQLITE_DONE` on the first call to `sqlite3_step()`.

Other commands, like many of the `PRAGMA` commands, return a single value. In this interface, these are returned as single-column, single-row tables. The first call to `sqlite3_step()` should return `SQLITE_ROW`, and the second call should return `SQLITE_DONE`. The second call is not actually required, and the application can simply reset or finalize the statement after the SQL return value is retrieved.

The `SELECT` command, and some `PRAGMA` commands, will return full result sets. These are returned one row at a time, using repeated calls to `sqlite3_step()`.

An application does not have to wait for `sqlite3_step()` to return `SQLITE_DONE` before it calls `sqlite3_reset()` or `sqlite3_finalize()`. The current execution can be canceled at any time.

If an error occurs, the results depend on how the statement was prepared. It is recommended that all new development use the `_v2` versions of `sqlite3_prepare()`. This makes `sqlite3_step()` return more specific error codes. For more information on how `sqlite3_step()` processes error codes, see [“Prepare v2” on page 149](#).

If the database connection encounters concurrency issues, calls to `sqlite3_step()` are where the errors will usually manifest themselves. If a required database lock is currently unavailable, the code `SQLITE_BUSY` will be returned. Properly dealing with this error code is a complex topic. See [“Database Locking” on page 151](#) for details.

### See Also

[sqlite3\\_prepare\\_xxx\(\)](#), [sqlite3\\_reset\(\)](#), [sqlite3\\_finalize\(\)](#)

---

**sqlite3\_stmt\_status()**

Get the status of a prepared statement resource [EXP]

**Definition**

```
int sqlite3_stmt_status( sqlite3_stmt* stmt, int option, int reset );
```

**stmt**

A prepared statement.

**option**

The status option to retrieve.

**reset**

If this value is nonzero, the requested status value is reset after it is returned.

**Returns**

The requested status value.

**Description**

This function retrieves status information from a prepared statement. Each prepared statement maintains several counter values. An application can request one of these counter values and optionally reset the counter to zero.

The available options include the number of scan, step, and sort operations. For a full list of the currently supported options, see [http://www.sqlite.org/c3ref/c\\_stmtstatus\\_fullscan\\_step.html](http://www.sqlite.org/c3ref/c_stmtstatus_fullscan_step.html).

**See Also**

[sqlite3\\_status\(\)](#), [sqlite3\\_db\\_status\(\)](#)

---

**sqlite3\_strnicmp()**

Compare two strings while ignoring case [EXP]

**Definition**

```
int sqlite3_strnicmp( const char* textA, const char* textB, int length );
```

**textA, textB**

Two UTF-8 encoded strings.

**length**

The maximum number of characters to compare.

**Returns**

A negative value will be returned if `textA < textB`, a zero value will be returned if `textA = textB`, and a positive value will be returned if `textA > textB`.

**Description**

This function allows an application to compare two strings using the same case-independent logic that SQLite uses internally. Remember that this is an order comparison function, not an “is equal” function. A result of zero (which is often interpreted as false) indicates that the two strings are equivalent.

sqlite3\_table\_column\_metadata()

The ability to ignore letter case only applies to characters with a character code of 127 or less. The behavior of this function when using character codes greater than 255 is somewhat undefined.

## See Also

[sqlite3\\_snprintf\(\)](#)

---

## sqlite3\_table\_column\_metadata()

Lookup extended column metadata

### Definition

```
int sqlite3_table_column_metadata( sqlite3* db,
    const char* db_name, const char* tbl_name, const char* col_name,
    const char** datatype, const char** collation,
    int* not_null, int* primary_key, int* autoincrement );
```

**db**

A database connection.

**db\_name**

A logical database name, encoded in UTF-8. The name may be `main`, `temp`, or a name given to `ATTACH DATABASE`.

**tbl\_name**

A table name.

**col\_name**

A column name.

**datatype**

A reference to a string. The declared datatype will be passed back. This is the datatype that appears in the `CREATE TABLE` statement.

**collation**

A reference to a string. The declared collation will be passed back.

**not\_null**

A reference to an integer. If a nonzero value is passed back, the column has a `NOT NULL` constraint.

**primary\_key**

A reference to an integer. If a nonzero value is passed back, the column is part of the table's primary key.

**autoincrement**

A reference to an integer. If a nonzero value is passed back, the column is set to `AUTO INCREMENT`. This implies the column is a `ROWID` alias, and has been designated as an `INTEGER PRIMARY KEY`.

*Returns*

An SQLite result code.

## Description

This function is used to retrieve information about a specific column. Given a database connection, a logical database name, a table name, and the name of the column, this function will pass back the original datatype (as given in the `CREATE TABLE` statement) and the default collation name. A set of flags will also be returned, indicating if the column has a `NOT NULL` constraint, if the column is part of the table's `PRIMARY KEY`, and if the column is part of an `AUTOINCREMENT` sequence.

If information on the `ROWID`, `OID`, or `_OID_` column is requested, the values returned depend on if the table has a user-defined `ROWID` alias column, designated as `INTEGER PRIMARY KEY`. If the table does have such a column, information on the user-defined column will be passed back, just as if it were a normal column. If the table does not have a `ROWID` alias column, the values ("`INTEGER`", "`BINARY`", `0`, `1`, `0`) will be passed back in the fifth through ninth parameters, respectively.

The datatype and collation names are passed back using static buffers. The application should not free these buffers. The buffers stay valid until another call to `sqlite3_table_column_metadata()` is made.

This function does not work with views. If an application attempts to query information about a view column, an error will be returned.

This function is only available if the SQLite library was compiled with the `SQLITE_ENABLE_COLUMN_METADATA` build option.

## See Also

[table\\_info](#) [PRAGMA, Ap F], [SQLITE\\_ENABLE\\_COLUMN\\_METADATA](#) [Build Opt, Ap A]

---

## sqlite3\_threadsafe()

Test if SQLite is thread-safe

### Definition

```
int sqlite3_threadsafe( );
```

### Returns

The compile-time value of `SQLITE_THREADSAFE`.

### Description

This function returns the compile time value of `SQLITE_THREADSAFE`. A value of zero indicates that no thread support is available. Any other value indicates some level of thread support is available. If the result is nonzero, the specific threading mode can be set for the whole library using `sqlite3_config()`, or for a specific database connection using `sqlite3_open_v2()`.

## See Also

[sqlite3\\_config\(\)](#), [sqlite3\\_open\\_v2\(\)](#), [SQLITE\\_THREADSAFE](#) [Build Opt, Ap A]

sqlite3\_total\_changes()

---

## sqlite3\_total\_changes()

Get the total number of changes made by a database connection

### Definition

```
int sqlite3_total_changes( sqlite3* db );
```

db

A database connection.

### Returns

The number of rows modified by this database connection since it was opened.

### Description

This function returns the number of table rows modified by any INSERT, UPDATE, or DELETE statements executed since the database connection was opened. The count includes modifications made by table triggers and foreign key actions, but does not include deletions made by REPLACE constraints, rollbacks, or truncated tables. Rows that are successfully modified within an explicit transaction and then subsequently rolled back are counted.

This function is exposed to the SQL environment as the SQL function `total_changes()`.

### See Also

[sqlite3\\_changes\(\)](#), [count\\_changes](#) [PRAGMA, Ap F], [total\\_changes\(\)](#) [SQL Func, Ap E]

---

## sqlite3\_trace()

Register an SQL statement trace callback [EXP]

### Definition

```
void* sqlite3_trace( sqlite3* db, trace_callback, void* udp);
```

```
void trace_callback( void* udp, const char* sql );
```

db

A database connection.

trace\_callback

An application-defined trace callback function.

udp

An application-defined user-data pointer. This value is made available to the trace function.

sql

The text of the SQL statement that was executed, encoded in UTF-8.

### Returns (sqlite3\_trace())

The previous user-data pointer, if applicable.

### Description

This function allows an application to register a trace function. The callback is called just before any SQL statement is processed. It may also be called when additional statements are processed, such as trigger bodies.



If the SQL text contains any statement parameters, these will be replaced with the actual values used for this execution.

### See Also

[sqlite3\\_profile\(\)](#)

---

## sqlite3\_unlock\_notify()

Install an unlock notification callback [EXP]

### Definition

```
int sqlite3_unlock_notify( sqlite* db, notify_callback, void* arg );
void notify_callback( void** argv, int argc );
```

**db**

A database connection.

**notify\_callback**

The unlock notification callback function.

**arg**

An application-specific notification record.

**argv**

An array of notification records.

**argc**

The number of notification records.

*Returns* (sqlite3\_unlock\_notify())

An SQLite result code.

### Description

This function registers an unlock notification callback. This can only be used in shared cache mode. If a database connection returns an `SQLITE_LOCKED` error, the application has a chance to install an unlock notification callback. This callback will be called when the lock becomes available, giving the callback a chance to process all of the outstanding notification records.

This is an advanced API call that requires significant understanding of the threading and locking modes used by a shared cache. For more information, see [http://www.sqlite.org/unlock\\_notify.html](http://www.sqlite.org/unlock_notify.html).

This function is only available if the SQLite library was compiled with the `SQLITE_ENABLE_UNLOCK_NOTIFY` build option.

### See Also

[SQLITE\\_ENABLE\\_UNLOCK\\_NOTIFY](#) [Build Opt, Ap A]

---

## sqlite3\_update\_hook()

Register an update callback

### Definition

```
void* sqlite3_update_hook( sqlite3* db, update_callback, void* udp );  
  
void update_callback( void* udp, int type,  
                     const char* db_name, const char* tbl_name, sqlite3_int64 rowid );
```

**db**

A database connection.

**update\_callback**

An application-defined callback function that is called when a database row is modified.

**udp**

An application-defined user-data pointer. This value is made available to the update callback.

**type**The type of database update. Possible values are `SQLITE_INSERT`, `SQLITE_UPDATE`, and `SQLITE_DELETE`.**db\_name**The logical name of the database that is being modified. Names include `main`, `temp`, or any name passed to `ATTACH DATABASE`.**tbl\_name**

The name of the table that is being modified.

**rowid**The ROWID of the row being modified. In the case of an `UPDATE`, this is the ROWID value after the modification has taken place.**Returns** (`sqlite3_update_hook()`)

The previous user-data pointer, if applicable.

### Description

This function allows an application to register an update callback. This callback is called when a database row is modified. The callback must not use the associated database connection to modify any databases, nor may it call `sqlite3_prepare_v2()` or `sqlite3_step()`.

The callback will be called when rows are modified by a trigger, but not when they are deleted because of a conflict resolution (such as `INSERT OR REPLACE`). The callback is not called when system tables (such as `sqlite_master`) are modified.

### See Also

[sqlite3\\_commit\\_hook\(\)](#), [sqlite3\\_rollback\\_hook\(\)](#)

---

## sqlite3\_user\_data()

Get user-data pointer from SQL function context

### Definition

```
void* sqlite3_user_data( sqlite3_context* ctx );
```

ctx

An SQL function context, provided by the SQLite library.

*Returns*

The user-data pointer passed into `sqlite3_create_function()`.

### Description

This function is used by an SQL function implementation to extract the user-data pointer from the function context. This allows a function to access the user-data pointer passed to `sqlite3_create_function()`.

### See Also

[sqlite3\\_create\\_function\(\)](#)

---

## sqlite3\_value\_xxx()

Get an SQL function parameter

### Definition

```
const void*      sqlite3_value_blob(    sqlite3_value* value );
double          sqlite3_value_double(  sqlite3_value* value );
int             sqlite3_value_int(      sqlite3_value* value );
sqlite3_int64   sqlite3_value_int64(    sqlite3_value* value );
const unsigned char* sqlite3_value_text(  sqlite3_value* value );
const void*     sqlite3_value_text16(   sqlite3_value* value );
const void*     sqlite3_value_text16le(  sqlite3_value* value );
const void*     sqlite3_value_text16be(  sqlite3_value* value );
```

value

An SQL function parameter provided by the SQLite library.

*Returns*

The extracted value.

### Description

These functions are used by an SQL function implementation to extract values from the SQL function parameters. If the requested type is different from the actual underlying value, the value will be converted using the conversion rules defined by [Table 7-1](#).

SQLite takes care of all the memory management for the buffers returned by these functions. Pointers returned will become invalid when the function implementation returns, or if another `sqlite3_value_xxx()` call is made using the same parameter value.

Be warned that `sqlite3_value_int()` will clip any integer values to 32 bits. If the SQL function is passed values that cannot be represented by a 32-bit signed integer, it is safer to use `sqlite3_column_int64()`. The buffer returned by `sqlite3_value_text()` and `sqlite3_value_text16()` will always be null-terminated.

sqlite3\_value\_bytes()

In most other regards, these functions are nearly identical to the `sqlite3_column_xxx()` functions.

### See Also

[sqlite3\\_value\\_bytes\(\)](#), [sqlite3\\_value\\_numeric\\_type\(\)](#), [sqlite3\\_column\\_xxx\(\)](#)

---

## sqlite3\_value\_bytes()

Get the size of an SQL function parameter

### Definition

```
int sqlite3_value_bytes(  sqlite3_value* value );
int sqlite3_value_bytes16( sqlite3_value* value );
```

value

An SQL function parameter value.

Returns

The number of bytes in the SQL function parameter value.

### Description

These functions return the number of bytes in a text or BLOB value. Calling these functions can cause a type conversion (invalidating buffers returned by `sqlite3_value_xxx()`), so care must be taken to call them in conjunction with the appropriate `sqlite3_value_xxx()` function.

To avoid problems, an application should first extract the desired type using an `sqlite3_value_xxx()` function, and then call the appropriate `sqlite3_value_bytes()` function. The functions `sqlite3_value_text()` and `sqlite3_value_blob()` should be followed by a call to `sqlite3_value_bytes()`, while any call to an `sqlite3_value_text16xxx()` should be followed by a call to `sqlite3_value_bytes16()`.

If these functions are called for a non-text or non-BLOB value, the value will first be converted to an appropriately encoded text value, then the length of that text value will be returned.

In most other regards, these functions are nearly identical to the `sqlite3_column_bytes()` functions.

### See Also

[sqlite3\\_value\\_xxx\(\)](#), [sqlite3\\_column\\_bytes\(\)](#)

---

## sqlite3\_value\_numeric\_type()

Attempt to get an SQL function parameter as a number

### Definition

```
int sqlite3_value_numeric_type( sqlite3_value* value );
```

value

An SQL function parameter value.

Returns

A datatype code.

## Description

This function attempts to convert the given parameter value into a numeric type. If the value can be converted into an integer or floating-point number without loss of data, the conversion is done and the type `SQLITE_INTEGER` or `SQLITE_FLOAT` will be returned.

If a conversion would result in lost data, the conversion is not done and the original datatype is returned. In that case, the type may be `SQLITE_TEXT`, `SQLITE_BLOB`, or `SQLITE_NULL`.

The difference between this function and simply calling a function like `sqlite3_value_int()` is the conversion function. This function will only perform the conversion if the original value is fully consumed and makes sense in a numeric context. For example, `sqlite3_value_int()` will convert a `NULL` into the value 0, where this function will not. Similarly, `sqlite3_value_int()` will convert the string `123xyz` into the integer value 123 and ignore the trailing `xyz`. This function will not allow that conversion, however, because no sense can be made of the trailing `xyz` in a numeric context.

## See Also

[sqlite3\\_value\\_xxx\(\)](#), [sqlite3\\_value\\_type\(\)](#)

---

## sqlite3\_value\_type()

Get the datatype of an SQL function parameter

### Definition

```
int sqlite3_value_type( sqlite3_value* value );
```

`value`

An SQL function parameter value.

### Returns

The native datatype code of the parameter value.

## Description

This function returns the initial datatype of an SQL function parameter. If this function is used, it should be called before any `sqlite3_value_xxx()` function. Once a type conversion takes place, the result of this function is undefined.

The return value will be `SQLITE_INTEGER`, `SQLITE_FLOAT`, `SQLITE_TEXT`, `SQLITE_BLOB`, or `SQLITE_NULL`.

In most other regards, this function is nearly identical to the `sqlite3_column_type()` function.

## See Also

[sqlite3\\_value\\_xxx\(\)](#), [sqlite3\\_value\\_numeric\\_type\(\)](#), [sqlite3\\_column\\_type\(\)](#)

---

## sqlite3\_version[]

Static version string

### Definition

```
extern const char sqlite3_version[];
```

### Description

This is not a function, but a static character array that holds the version string of the SQLite library. This is the same value returned by `sqlite3_libversion()`. The version string for SQLite v3.6.23 is "3.6.23". The version string for v3.6.23.1 is "3.6.23.1".

This value is also available at compile time as the `SQLITE_VERSION` macro. By comparing the macro used at compile time to the `sqlite3_version` value found in the current library, an application can verify that it is linking against the correct version of the library.

### See Also

[sqlite3\\_libversion\(\)](#)

---

## sqlite3\_vfs\_find()

Get a VFS module by name

### Definition

```
sqlite3_vfs* sqlite3_vfs_find( const char* name );
```

name

The name of the VFS module. If NULL, the default VFS module will be returned.

Returns

A reference to a VFS module. If the named module does not exist, a NULL will be returned.

### Description

This function is used to search for a specific VFS module by name. This allows a stub or pass-through VFS module to find an underlying VFS implementation.

To use a custom VFS module with a database connection, simply pass the VFS name to `sqlite3_open_v2()`. Calling this function is not required.

### See Also

[sqlite3\\_vfs\\_register\(\)](#), [sqlite3\\_open\\_v2\(\)](#)

---

## sqlite3\_vfs\_register()

Register a custom VFS module

### Definition

```
int sqlite3_vfs_register( sqlite3_vfs* vfs, int make_default );
```

vfs

A VFS module.

`make_default`

If this value is nonzero, the given VFS module will become the default module.

*Returns*

An SQLite result code.

### Description

This function registers an application-defined VFS module with the SQLite. The new module can also be made the default for new database connections. The same module (under the same name) can be safely registered multiple times. To make an existing module the default module, just reregister it with the default flag set.

VFS modules are an advanced SQLite topic. For more information, see <http://www.sqlite.org/c3ref/vfs.html>.

### See Also

[sqlite3\\_vfs\\_find\(\)](#), [sqlite3\\_vfs\\_unregister\(\)](#)

## sqlite3\_vfs\_unregister()

Unregister a VFS module

### Definition

```
int sqlite3_vfs_unregister( sqlite3_vfs* vfs );
```

`vfs`

A VFS module.

*Returns*

An SQLite result code.

### Description

This function is used to unregister a VFS module. No database connections should be using the module. If the default module is unregistered, a new default will be picked arbitrarily.

### See Also

[sqlite3\\_vfs\\_register\(\)](#)

## sqlite3\_vmprintf()

Format and allocate a string

### Definition

```
char* sqlite3_vmprintf( const char* format, va_list addl_args );
```

`format`

An `sqlite3_snprintf()` style message formatting string.

`addl_args`

A C var-arg list of arguments.

*Returns*

A newly allocated string built from the given parameters.

sqlite3\_vmprintf()

## Description

This function is nearly identical to `sqlite3_mprintf()`, but it takes a C var-arg list, rather than a variable number of function parameters. This can be used to build application-specific `printf()` style functions.

## See Also

[sqlite3\\_mprintf\(\)](#), [sqlite3\\_snprintf\(\)](#)



## Symbols

!= (not equal) operator, 33, 348  
% (modulo) operator, 33, 347  
& (binary AND) bitwise operator, 33, 347  
' (single quote), 31  
\* (asterisk), 71  
\* (multiplication) operator, 33, 347  
+ (addition) operator, 33, 347  
+ (positive sign) operator, 33, 346  
, (comma), 31  
- (sign negation) operator, 33, 346  
- (subtraction) operator, 33, 347  
/ (division) operator, 33, 347  
; (semicolon), 30, 299  
< (less than) operator, 33, 348  
<< (bit shift) operator, 33, 347  
<= (less than or equal to) operator, 33, 348  
<> (not equal) operator, 33, 348  
= (equal) operator, 32, 33, 348  
== (equal) operator, 33, 348  
> (greater than) operator, 33, 348  
>= (greater than or equal to) operator, 33, 348  
>> (bit shift) operator, 33, 347  
[ ] (square brackets), 30  
\ (backslash), 31  
` (back tick), 30  
| (binary OR) bitwise operator, 33, 347  
|| (string concatenation) operator, 33, 347  
~ (bit inversion) operator, 33, 346

## A

abs() function, 361  
access control, 14  
ACID transactions, 51–53

addition (+) operator, 33, 347  
adjacency model, 99–101  
aggregate functions  
  aggregate context, 195–197  
  built-in, 378–380  
  defined, 71, 181, 194, 349, 361  
  defining aggregates, 194  
  usage examples, 197–200  
ALTER TABLE command  
  ADD COLUMN variant, 301  
  functionality, 43  
  RENAME variant, 301  
  syntax, 300–301  
amalgamation  
  defined, 19  
  source downloads, 20  
  source files, 19  
American National Standards Institute (ANSI), 28  
ANALYZE command, 301–302  
AND operator  
  binary operations, 347  
  logical operations, 33, 348, 350  
  three valued logic, 32  
ANSI (American National Standards Institute), 28  
ANSI join notation, 78  
application cache, 11  
application files, 10  
APSW module, 173  
archives, SQLite support, 11  
AS keyword, 68, 70  
ASC keyword, 74  
asterisk (\*), 71  
atoi() function, 258

ATTACH DATABASE command, 303  
autocommit mode, 53  
auto\_vacuum pragma, 383–384  
avg() function, 84, 378

## B

back tick (`), 30  
backslash (\), 31  
.backup command, 290  
.bail command, 290  
BCNF (Boyce-Codd Normal Form), 103  
BEGIN IMMEDIATE command, 54  
BEGIN TRANSACTION command  
    avoiding SQLITE\_BUSY, 154  
    errors and, 151  
    syntax, 53, 304  
BETWEEN expression, 350  
binary AND (&) bitwise operator, 33, 347  
binary bit shift, 33, 347  
BINARY collation, 200  
binary operators, 33, 346–348  
binary OR (|) bitwise operator, 33, 347  
bit inversion (~) operator, 33, 346  
bit shift operator, 33, 347  
BLOB datatype  
    defined, 37, 343  
    one-to-one relationships and, 94  
    SQL syntax, 31  
bound parameters (see statement parameters)  
Boyce-Codd Normal Form (BCNF), 103  
bridge tables, 97

## C

### C APIs

bound parameters, 133–142  
convenience functions, 142–146  
database connections, 120–123  
datatypes supported, 116, 410–413  
error codes, 118, 148–156  
functions supported, 413–490  
library initialization, 119  
overview, 115–119  
prepared statements, 123–133  
result codes, 146–148  
structures and allocations, 118  
utility functions, 156–158  
C++ language, 175  
cache, application, 11

cache\_size pragma, 384  
CamelCase, 116  
CASE expression, 351  
case sensitivity, 30  
case\_sensitive\_like pragma, 385  
CAST expression, 351  
CEROD extension, 180  
changes() function, 362  
client/server framework  
    SQLite limitations, 14  
    SQLite stand-in, 11  
coalesce() function, 362  
COLLATE operator, 352  
collations  
    defined, 39, 181  
    registering, 201  
    usage examples, 202  
collation\_list pragma, 386  
column constraints (tables), 38, 313  
column names, 349  
column typing, 36–38  
comma (,), 31  
comments  
    C syntax, 30  
    SQL syntax, 30  
COMMIT TRANSACTION command, 54, 305  
compound SELECT statements, 77–78  
concatenation (||) operator, 33, 347  
configuring SQLite, 4, 21  
conversions  
    datatype rules, 129  
    date and time, 163–165  
Coordinated Universal Time (UTC), 44, 162  
count() function, 378  
count\_changes pragma, 126, 386  
CREATE INDEX command, 44, 306–307  
CREATE TABLE command  
    column constraints, 38, 313  
    conflict clause, 315  
    creating tables from queries, 42  
    identifying foreign keys, 89  
    identifying primary key, 88  
    PRIMARY KEY constraint, 40, 314  
    syntax, 36, 308–315  
    table constraints, 41, 314  
    usage examples, 132  
CREATE TRIGGER command, 316–318  
CREATE VIEW command, 43, 319

- CREATE VIRTUAL TABLE command
  - functionality, 43
  - syntax, 221, 246, 320
- CROSS JOIN, 64, 80
- CURRENT\_DATE literal, 39, 166, 344
- CURRENT\_TIME literal, 39, 166, 344
- CURRENT\_TIMESTAMP literal, 39, 166, 344

## D

- Data Control Language (DCL), 34
- Data Definition Language (see DDL)
- Data Manipulation Language (see DML)
- data stores, SQLite support, 11
- Database Administrator (DBA), 111
- database connections
  - closing, 122
  - deadlocks, 153, 154
  - opening, 120
  - special cases, 121
  - usage examples, 122
- database design
  - indexes, 107–112
  - Normal Forms, 102–106
  - structures and relationships, 93–102
  - tables and keys, 87–93
  - transferring experience, 112–114
- database locking
  - avoiding SQLITE\_BUSY, 154
  - busy handlers, 152
  - deadlocks, 153, 154
  - purpose, 151
  - read-only, 155
- .databases command, 290
- database\_list pragma, 219, 224, 386
- datatype conversion rules, 129
- date and time features
  - application requirements, 160
  - convenience functions, 165
  - conversion function, 163–165
  - literal expressions, 166
  - representations, 160–162
  - usage examples, 167
- date() function, 166, 362
- datetime() function, 166, 363
- Daylight Saving Time (DST), 162
- DB-API 2.0 interface, 173
- DBA (Database Administrator), 111
- DBD::SQLite module, 172
- DBI interface, 172

- dblist module example
  - about, 224
  - create and connect, 224–229
  - cursor sequence, 240
  - custom functions, 231
  - disconnect and destroy, 229
  - extracting and returning data, 237–239
  - filtering rows, 235–236
  - query optimization, 230
  - registering modules, 243
  - table cursors, 233
  - table rename, 232
  - transaction control, 241
  - usage example, 245
  - virtual table modifications, 239
- DCL (Data Control Language), 34
- DDL (Data Definition Language)
  - about, 34
  - indexes, 44
  - tables, 35–43
  - views, 43
- deadlocks, 153, 154
- declarative languages, 28
- default\_cache\_size pragma, 387
- DEFERRED keyword, 53, 154
- #define macros, 156
- DELETE command
  - syntax, 48, 320
  - WHERE clause, 321
- denormalization, 103
- DESC keyword, 74
- DETACH DATABASE command, 321
- detail tables, 94
- DISTINCT keyword, SELECT command, 63, 74
- division (/) operator, 33, 347
- DML (Data Manipulation Language)
  - about, 34, 45
  - DELETE command, 48
  - INSERT command, 46–48
  - SELECT command, 49–51
  - UPDATE command, 48
- documentation distribution, 18
- DROP INDEX command, 45, 322
- DROP TABLE command
  - dblist module example, 229
  - deleting FTS tables, 170
  - functionality, 43
  - syntax, 322

DROP TRIGGER command, 323  
DROP VIEW command, 44, 323  
.dump command, 291

## E

.echo command, 291  
embedded systems development, 176–180  
ENABLE\_READLINE directive, 269  
encoding pragma, 387  
encryption, 180  
END TRANSACTION command, 54, 324  
entry points, 206, 215  
equal (=) operator, 32, 33, 348  
equal (==) operator, 33, 348  
error codes

- C API conventions, 118, 146–156
- scalar functions, 186–188

EXCEPT operator, 77  
EXCLUSIVE keyword, 53, 154  
EXISTS operator, 76, 353  
.exit command, 291  
EXPLAIN command, 112, 324  
.explain command, 291  
EXPLAIN QUERY PLAN command, 112  
explicit join notation, 78  
expressions (see specific types of expressions)  
extensions

- architectural overview, 205
- defined, 181, 204
- design considerations, 206
- entry points, 206, 215
- loadable, 182, 204, 211–215
- static, 204, 209–211
- usage examples, 207–208

external modules, 218

## F

Fifth Normal Form, 106  
file-globbing, 354  
First Normal Form, 104  
floating-point numbers, 36, 343  
foreign key constraints, 90–91  
foreign keys

- defined, 89
- many-to-many relationships, 97
- one-to-many relationships, 95
- table constraints, 89

foreign\_keys pragma, 90, 388

foreign\_key\_list pragma, 388  
format() function, 182  
Fourth Normal Form, 106  
freelist\_count pragma, 389  
FROM clause, SELECT command

- functionality, 50, 63
- joining tables, 63–68, 78
- table aliases, 67

FTS (Full Text Search) engine

- additional resources, 171
- creating and populating tables, 169
- internal modules and, 218
- searching FTS tables, 170

FTS (Full-Text Search) engine

- functionality, 169

FULL OUTER JOIN, 66  
fullsync pragma, 390  
full\_column\_names pragma, 389  
function calls

- busy handlers, 152
- C API support, 116
- defined, 348

## G

general expressions, 350–359  
generic ID keys, 91–92  
GLOB operator, 33, 353  
glob() function, 363  
greater than (>) operator, 33, 348  
greater than or equal to (>=) operator, 33, 348  
Greenwich Mean Time, 162  
GROUP BY clause, SELECT command

- flattening row groups, 72
- functionality, 63, 69
- usage examples, 84

group\_concat() function, 379

## H

HAVING clause, SELECT command, 63, 73  
.headers command, 25, 292  
.help command, 292  
hex() function, 364  
HIDDEN keyword, 249  
hierarchical relationships

- adjacency model, 100
- common operations, 99
- nested set, 101

Hwaci, Inc., 180

## I

- ICU (International Components for Unicode), 167, 282
- ifnull() function, 363
- ignore\_check\_constraints pragma, 390
- IMMEDIATE keyword, 53, 154
- imperative languages, 28
- implicit join notation, 78
- .import command, 292
- IN operator
  - functionality, 33, 354
  - subquery support, 76
- incremental\_vacuum pragma, 390
- indexes
  - column order, 109
  - creating, 44
  - defined, 44, 107
  - as diverse, 108
  - dropping, 45
  - multicolumn limitations, 110
  - overview, 111–112
  - primary keys and, 109
  - usage examples, 107
- index\_info pragma, 391
- index\_list pragma, 391
- .indices command, 293
- INNER JOIN, 65–66, 80
- INSERT command
  - bound parameters and, 134, 141
  - syntax, 46–48, 325–327
- integers, 36, 342
- integrity\_check pragma, 392
- internal modules, 218, 242
- International Components for Unicode (ICU), 167, 282
- International Standards Organization (ISO), 28
- INTERSECT operator, 77
- .iotrace command, 293
- iPhone (Apple), 178
- IS NOT operator, 355
- IS operator, 355
- isdigit() function, 203
- ISNULL operator, 356
- ISO (International Standards Organization), 28

## J

- Java Database Compatibility (JDBC) interface, 174
- Java language, 174
- JOIN operators
  - alternate notation, 78
  - combining tables, 63–68
  - usage examples, 80
- journal\_mode pragma, 392
- journal\_size\_limit pragma, 393
- Julian Day calendar, 160
- julianday() function, 166, 364

## K

- Kent, William, 106
- keys
  - design considerations, 113
  - tables and, 87–93
- keyword expressions, 350–359

## L

- last\_insert\_rowid() function, 364
- LEFT OUTER JOIN, 66, 82
- legacy\_file\_format pragma, 394
- length() function, 365
- less than (<) operator, 33, 348
- less than or equal to (<=) operator, 33, 348
- library initialization, 119
- LIKE operator, 33, 356
- like() function, 365
- LIMIT clause, SELECT command, 63, 75
- link tables, 97
- literal expressions
  - date and time, 166
  - SQL syntax, 30
  - supported datatypes, 342–345
- .load command, 293
- loadable extensions, 182, 204, 211–215
- load\_extension() function, 366
- locking\_mode pragma, 154, 177, 395
- lock\_proxy\_file pragma, 396
- lock\_status pragma, 396
- .log command, 294
- logic operations, 33, 345
- logical AND operator, 348
- logical OR operator, 348
- lower() function, 168, 366
- ltrim() function, 366

## M

- manifest typing, 36
- many-to-many relationships, 97–99
- MATCH operator
  - FTS engine and, 170
  - functionality, 33, 357
- match() function, 367
- max() function, 367, 379
- max\_page\_count pragma, 397
- MDB2 interface, 173
- memory management
  - mobile devices, 176
  - utility functions, 157
- min() function, 368, 380
- mobile device development, 176–180
- .mode command, 25, 294
- module API, 220–224
- modules
  - additional information, 217
  - categories of, 218
  - defined, 217
  - registering, 243, 259
- modulo (%) operator, 33, 347
- multiplication (\*) operator, 33, 347

## N

- NATURAL JOIN, 66, 82
- negative sign (-) operator, 33, 346
- nested set representation, 101
- nested transactions, 55–57
- .NET technologies, 175
- NOCASE collation, 200
- Normal Forms
  - defined, 102
  - denormalization, 103
  - Fifth Normal Form, 106
  - First Normal Form, 104
  - Fourth Normal Form, 106
  - normalization, 103
  - Second Normal Form, 104
  - Third Normal Form, 105
- normalization, 102, 103
- not equal (!=) operator, 33, 348
- not equal (<>) operator, 33, 348
- NOT operator
  - functionality, 33, 346
  - three valued logic, 32
- NOTNULL operator, 356, 357

- NULL datatype
  - defined, 36, 342
  - SQL syntax, 31–32
- nullif() function, 368
- .nullvalue command, 295

## O

- ODBC (Open Database Connectivity), 175
- OFFSET clause, SELECT command, 63, 75
- omit\_readlock pragma, 397
- one-to-many relationships, 89, 95–97
- one-to-one relationships, 93–94
- Open Database Connectivity (ODBC), 175
- OR operator
  - binary operations, 347
  - logical operations, 33, 348, 357
  - three valued logic, 32
- ORDER BY clause, SELECT command, 63, 74, 85
- OUTER JOIN, 66
- .output command, 296

## P

- page\_count pragma, 398
- page\_size pragma, 176, 398
- parser\_trace pragma, 399
- PDO (PHP Data Objects) interface, 173
- PEAR-DB interface, 173
- performance, statement parameters, 138–140
- Perl language, 172
- PHP language, 173
- positive sign (+) operator, 33, 346
- PRAGMA command, 383
  - (see also specific pragmas)
  - functionality, 381–383
  - mobile devices and, 178
  - syntax, 327
- prepared statements
  - preparing, 124
  - resetting and finalizing, 130
  - result columns, 127–130
  - statement life cycle, 123–124
  - statement transitions, 131
  - stepping through, 126–127
  - usage examples, 132
- PRIMARY KEY constraint, 40, 314
- primary keys
  - defined, 87

- indexes and, 109
  - multicolumn, 92
- proleptic Gregorian calendar, 160
- .prompt command, 296
- SQLite module, 173
- Python language, 173

## Q

- queries
  - creating tables from, 42
  - dblist module example, 230
  - sort considerations, 62
- quick\_check pragma, 399
- .quit command, 296
- quote() function, 368

## R

- R\*Tree module, 171, 218
- RAISE expression, 358
- random() function, 369
- randblob() function, 369
- RDBMS (relational database management system), 1, 9
  - .read command, 25, 296
  - read\_uncommitted pragma, 399
- real numbers, 36, 343
- recursive\_triggers pragma, 400
- regex() function, 369
- REGEXP operator, 33, 358
- REINDEX command, 328
- relational database management system (RDBMS), 1, 9
  - RELEASE SAVEPOINT command, 55, 328
  - remainder (%) operator, 347
  - REPLACE command, 329
  - replace() function, 370
  - replication, 15
  - .restore command, 297
  - result codes
    - C APIs, 146–148
    - scalar functions, 186–188
  - reverse\_unordered\_selects pragma, 62, 400
  - RIGHT OUTER JOIN, 66
  - ROLLBACK TO command, 55
  - ROLLBACK TRANSACTION command, 54, 329
  - round() function, 370
  - RTRIM collation, 200

- rtrim() function, 370

## S

- save-points, 55–57
- SAVEPOINT command, 55, 330
- scalar functions
  - built-in, 361–378
  - calling, 348
  - defined, 181, 182, 361
  - extracting parameters, 184–186
  - registering functions, 182–184
  - returning results and errors, 186–188
  - usage examples, 189–193
- .schema command, 25, 297
- schema\_version pragma, 401
- scripting languages (see specific languages)
- search, full text (see FTS engine)
- Second Normal Form, 104
- secure\_delete pragma, 401
- security
  - loadable extensions, 213
  - statement parameters, 138–140
- SEE (SQLite Encryption Extension), 180
- SELECT command
  - additional clauses, 333, 334
  - compound SELECT statements, 77–78
  - compound statements, 335
  - DISTINCT keyword, 63, 74
  - expression support, 341
  - FROM clause, 50, 63–68, 67, 78
  - functionality, 49–51, 61
  - GROUP BY clause, 63, 69, 72, 84
  - HAVING clause, 63, 73
  - LIMIT clause, 63, 75
  - OFFSET clause, 63, 75
  - ORDER BY clause, 63, 74, 85
  - SELECT header, 63, 70–73
  - subquery support, 76
  - syntax, 62, 331–335
  - usage examples, 79–85
  - WHERE clause, 50, 63, 68, 83, 334
  - wildcard support, 71
- SELECT expression, 359
- SELECT header, SELECT command, 63, 70–73
- semicolon (;), 30, 299
- .separator command, 297
- shadow tables, 218, 242
- shell.c source file, 20

- short\_column\_names pragma, 402
- .show command, 297
- sign negation (-) operator, 33, 346
- single quote ('), 31
- snprintf() function, 138
- source distributions
  - amalgamation, 19
  - source downloads, 20
  - source files, 19
- SQL (Structured Query Language)
  - about, 27, 28
  - additional resources, 58
  - case sensitivity, 30
  - DCL support, 34
  - DDL support, 34–45
  - as declarative language, 28
  - DML support, 34, 45–51
  - general syntax, 30–33
  - important command, 28
  - learning, 27
  - portability, 29
  - system catalogs, 57
  - table structure, 61
  - TCL support, 34, 51–57
- SQL commands (see specific commands)
- SQLite
  - building and installing, 17–26
  - common uses, 9–13
  - configuring, 4, 21
  - database requirements, 4
  - defined, 1
  - embedded device support, 5
  - licensing considerations, 6
  - limitations, 13
  - list of users, 15
  - reliability, 6
  - server requirements, 2–4
  - unique features, 5
- SQLite analyzer, 18
- SQLite build options
  - debug settings, 280
  - default values, 270–273
  - enable extensions, 281–284
  - limit features, 285
  - omit core features, 285
  - operation and behavior, 278–280
  - shell directives, 269
  - sizes and limits, 273–278
- SQLite core, 17, 178
- SQLite Encryption Extension (SEE), 180
- SQLite Manager extension (Firefox), 180
- sqlite-3\_x\_x-tea.tar.gz file, 20
- sqlite-amalgamation-3\_x\_x.tar.gz file, 20
- sqlite-amalgamation-3\_x\_x.zip file, 20
- sqlite-source-3\_x\_x.zip file, 20
- sqlite.h source file, 20
- sqlite3 application
  - about, 17, 24, 287, 288
  - .backup command, 290
  - .bail command, 290
  - bail option, 288
  - batch option, 288
  - column option, 288
  - csv option, 288
  - .databases command, 290
  - dot-commands, 289
  - .dump command, 291
  - .echo command, 291
  - echo option, 288
  - .exit command, 291
  - .explain command, 291
  - header option, 288
  - .headers command, 25, 292
  - .help command, 292
  - help option, 289
  - html option, 289
  - .import command, 292
  - .indices command, 293
  - init option, 288
  - interactive option, 289
  - .iotrace command, 293
  - line option, 289
  - list option, 289
  - .load command, 293
  - .log command, 294
  - .mode command, 25, 294
  - noheader option, 288
  - .nullvalue command, 295
  - nullvalue option, 289
  - .output command, 296
  - precompiled distributions, 18
  - .prompt command, 296
  - .quit command, 296
  - .read command, 25, 296
  - .restore command, 297
  - .schema command, 25, 297
  - .separator command, 297
  - separator option, 289



- .show command, 297
- .tables command, 298
- .timeout command, 298
- .timer command, 298
- version option, 289
- .width command, 298
- sqlite3 structure, 410
- sqlite3.c source file, 19
- sqlite3ext.h source file, 20, 206
- sqlite3\_aggregate\_context() function, 195, 413
- sqlite3\_auto\_extension() function, 209, 414
- sqlite3\_backup structure, 410
- sqlite3\_backup\_finish() function, 415
- sqlite3\_backup\_init() function, 415
- sqlite3\_backup\_pagecount() function, 416
- sqlite3\_backup\_remaining() function, 416
- sqlite3\_backup\_step() function, 152, 417
- sqlite3\_bind\_parameter\_count() function, 137, 419
- sqlite3\_bind\_parameter\_index() function, 138, 419
- sqlite3\_bind\_parameter\_name() function, 138, 420
- sqlite3\_bind\_xxx() function, 135–137, 418
- sqlite3\_blob structure, 410
- sqlite3\_blob\_bytes() function, 420
- sqlite3\_blob\_close() function, 421
- sqlite3\_blob\_open() function, 152, 421
- sqlite3\_blob\_read() function, 422
- sqlite3\_blob\_write() function, 422
- sqlite3\_busy\_handler() function, 153, 423
- sqlite3\_busy\_timeout() function, 152, 424
- sqlite3\_changes() function, 424
- sqlite3\_clear\_bindings() function, 138, 425
- sqlite3\_close() function, 122, 152, 425
- sqlite3\_collation\_needed() function, 426
- sqlite3\_column\_blob() function, 128
- sqlite3\_column\_bytes() function, 129, 428
- sqlite3\_column\_bytes16() function, 129
- sqlite3\_column\_count() function, 127, 428
- sqlite3\_column\_database\_name() function, 429
- sqlite3\_column\_decltype() function, 429
- sqlite3\_column\_double() function, 128
- sqlite3\_column\_int() function, 128
- sqlite3\_column\_int64() function, 128
- sqlite3\_column\_name() function, 127, 430
- sqlite3\_column\_name16() function, 127
- sqlite3\_column\_origin\_name() function, 431
- sqlite3\_column\_table\_name() function, 431
- sqlite3\_column\_text() function, 117, 128
- sqlite3\_column\_text16() function, 117, 128
- sqlite3\_column\_type() function, 127, 432
- sqlite3\_column\_value() function, 128
- sqlite3\_column\_xxx() function, 126, 427
- sqlite3\_commit\_hook() function, 432
- sqlite3\_compileoption\_get() function, 433
- sqlite3\_compileoption\_used() function, 434
- sqlite3\_complete() function, 434
- sqlite3\_config() function, 177, 435
- sqlite3\_context structure, 411
- sqlite3\_context\_db\_handle() function, 186, 436
- sqlite3\_create\_collation() function, 201, 436–437
- sqlite3\_create\_collation16() function, 201
- sqlite3\_create\_collation\_v2() function, 201
- sqlite3\_create\_function() function, 116, 183, 438
- sqlite3\_create\_function16() function, 183
- sqlite3\_create\_module() function, 220, 224, 440
- sqlite3\_create\_module\_v2() function, 221
- sqlite3\_data\_count() function, 440
- sqlite3\_db\_config() function, 441
- sqlite3\_db\_handle() function, 441
- sqlite3\_db\_mutex() function, 442
- sqlite3\_db\_status() function, 442
- sqlite3\_declare\_vtab() function, 227, 443
- sqlite3\_enable\_load\_extension() function, 213, 443
- sqlite3\_enable\_shared\_cache() function, 444
- sqlite3\_errcode() function, 148, 444
- sqlite3\_errmsg() function, 148, 445
- sqlite3\_errmsg16() function, 148
- sqlite3\_exec() function, 139, 143, 446
- sqlite3\_extended\_errcode() function, 148, 447
- sqlite3\_extended\_result\_codes() function, 148, 448
- sqlite3\_file\_control() function, 448
- sqlite3\_finalize() function, 127, 131, 449
- sqlite3\_free() function, 158, 449
- sqlite3\_free\_table() function, 145, 450
- sqlite3\_get\_autocommit() function, 151, 450
- sqlite3\_get\_auxdata() function, 450
- sqlite3\_get\_table() function, 145, 451
- sqlite3\_index\_info structure, 231

sqlite3\_initialize() function, 119, 452  
 sqlite3\_int64 structure, 411  
 sqlite3\_interrupt() function, 147, 452  
 sqlite3\_last\_insert\_rowid() function, 453  
 sqlite3\_libversion() function, 156, 453  
 sqlite3\_libversion\_number() function, 156, 454  
 sqlite3\_limit() function, 189–193, 454  
 sqlite3\_load\_extension() function, 214, 455  
 sqlite3\_log() function, 456  
 sqlite3\_malloc() function, 157, 456  
 sqlite3\_memory\_highwater() function, 457  
 sqlite3\_memory\_used() function, 457  
 sqlite3\_module structure, 221, 244, 411  
 sqlite3\_mprintf() function, 146, 226, 457  
 sqlite3\_mutex structure, 412  
 sqlite3\_mutex\_alloc() function, 458  
 sqlite3\_mutex\_enter() function, 458  
 sqlite3\_mutex\_free() function, 459  
 sqlite3\_mutex\_held() function, 459  
 sqlite3\_mutex\_leave() function, 460  
 sqlite3\_mutex\_notheld() function, 460  
 sqlite3\_mutex\_try() function, 460  
 sqlite3\_next\_stmt() function, 461  
 sqlite3\_open() function, 117, 120, 461  
 sqlite3\_open16() function, 120  
 sqlite3\_open\_v2() function, 117, 120, 462–463  
 sqlite3\_overload\_function() function, 464  
 sqlite3\_prepare\_xxx() function, 125, 133, 464  
 sqlite3\_profile() function, 465  
 sqlite3\_progress\_handler() function, 466  
 sqlite3\_randomness() function, 467  
 sqlite3\_realloc() function, 157, 467  
 sqlite3\_release\_memory() function, 468  
 sqlite3\_reset() function, 127, 130, 468  
 sqlite3\_reset\_auto\_extension() function, 469  
 sqlite3\_result\_error\_xxx() function, 188, 470  
 sqlite3\_result\_xxx() function, 187, 469  
 sqlite3\_rollback\_hook() function, 471  
 sqlite3\_set\_authorizer() function, 472  
 sqlite3\_set\_auxdata() function, 473  
 sqlite3\_shutdown() function, 119, 473  
 sqlite3\_sleep() function, 474  
 sqlite3\_snprintf() function, 146, 474  
 sqlite3\_soft\_heap\_limit() function, 476  
 sqlite3\_sourceid() function, 156, 476  
 sqlite3\_sql() function, 476  
 sqlite3\_status() function, 477  
 sqlite3\_step() function, 126, 149, 236, 478  
 sqlite3\_stmt structure, 123–133, 412  
 sqlite3\_stmt\_status() function, 112, 479  
 sqlite3\_strncmp() function, 479  
 sqlite3\_table\_column\_metadata() function, 480  
 sqlite3\_threadsafe() function, 481  
 sqlite3\_total\_changes() function, 482  
 sqlite3\_trace() function, 482  
 sqlite3\_uint64 structure, 411  
 sqlite3\_unlock\_notify() function, 483  
 sqlite3\_update\_hook() function, 484  
 sqlite3\_user\_data() function, 186, 485  
 sqlite3\_value structure, 412  
 sqlite3\_value\_blob() function, 185  
 sqlite3\_value\_bytes() function, 186, 486  
 sqlite3\_value\_bytes16() function, 186  
 sqlite3\_value\_double() function, 185  
 sqlite3\_value\_int() function, 185  
 sqlite3\_value\_int64() function, 185  
 sqlite3\_value\_numeric\_type() function, 185, 198, 486, 487  
 sqlite3\_value\_text() function, 185  
 sqlite3\_value\_text16() function, 185  
 sqlite3\_value\_type() function, 185, 487  
 sqlite3\_value\_xxx() function, 485  
 sqlite3\_version[] function, 488  
 sqlite3\_vfs structure, 413  
 sqlite3\_vfs\_find() function, 488  
 sqlite3\_vfs\_register() function, 488  
 sqlite3\_vfs\_unregister() function, 489  
 sqlite3\_vmprintf() function, 146, 489  
 sqlite3\_vtab structure, 225  
 sqlite3\_vtab\_cursor structure, 233  
 SQLiteJDBC package, 174  
 SQLiteODBC package, 175  
 SQLITE\_ABORT return code, 147  
 SQLITE\_AUTH return code, 147  
 SQLITE\_BUSY return code, 147, 151, 152, 154  
 SQLITE\_CANTOPEN return code, 147  
 SQLITE\_CASE\_SENSITIVE\_LIKE directive, 278  
 sqlite\_compileoption\_get() function, 371  
 sqlite\_compileoption\_used() function, 371  
 SQLITE\_CONSTRAINT return code, 147  
 SQLITE\_CORRUPT return code, 147  
 SQLITE\_DEBUG directive, 281

SQLITE\_DEFAULT\_AUTOVACUUM directive, 270  
 SQLITE\_DEFAULT\_CACHE\_SIZE directive, 271  
 SQLITE\_DEFAULT\_FILE\_FORMAT directive, 271  
 SQLITE\_DEFAULT\_JOURNAL\_SIZE\_LIMIT directive, 271  
 SQLITE\_DEFAULT\_MEMSTATUS directive, 272  
 SQLITE\_DEFAULT\_PAGE\_SIZE directive, 272  
 SQLITE\_DEFAULT\_TEMP\_CACHE\_SIZE directive, 272  
 SQLITE\_DISABLE\_DIRSYNC directive, 285  
 SQLITE\_DISABLE\_LFS directive, 285  
 SQLITE\_EMPTY return code, 147  
 SQLITE\_ENABLE\_ATOMIC\_WRITE directive, 281  
 SQLITE\_ENABLE\_COLUMN\_METADATA directive, 282  
 SQLITE\_ENABLE\_FTS3 directive, 169, 282  
 SQLITE\_ENABLE\_FTS3\_PARENTHESES directive, 169, 282  
 SQLITE\_ENABLE\_ICU directive, 168, 282  
 SQLITE\_ENABLE\_IOTRACE directive, 282  
 SQLITE\_ENABLE\_LOCKING\_STYLE directive, 283  
 SQLITE\_ENABLE\_MEMORY\_MANAGEMENT directive, 283  
 SQLITE\_ENABLE\_MEMSYS3 directive, 283  
 SQLITE\_ENABLE\_MEMSYS5 directive, 283  
 SQLITE\_ENABLE\_RTREE directive, 284  
 SQLITE\_ENABLE\_STAT2 directive, 284  
 SQLITE\_ENABLE\_UNLOCK\_NOTIFY directive, 284  
 SQLITE\_ENABLE\_UPDATE\_DELETE\_LIMIT directive, 284  
 SQLITE\_ERROR return code, 146  
 SQLITE\_EXTENSION\_INIT1 macro, 206  
 SQLITE\_FORMAT return code, 147  
 SQLITE\_FULL return code, 147, 151  
 SQLITE\_HAVE\_ISNAN directive, 278  
 sqlite\_int64 structure, 411  
 SQLITE\_INTERNAL return code, 146  
 SQLITE\_INTERRUPT return code, 147, 151  
 SQLITE\_IOERR return code, 147, 151, 152, 156  
 SQLITE\_LOCKED return code, 147  
 sqlite\_master catalog, 57  
 SQLITE\_MAX\_ATTACHED directive, 274  
 SQLITE\_MAX\_COLUMN directive, 274  
 SQLITE\_MAX\_COMPOUND\_SELECT directive, 274  
 SQLITE\_MAX\_DEFAULT\_PAGE\_SIZE directive, 275  
 SQLITE\_MAX\_EXPR\_DEPTH directive, 275  
 SQLITE\_MAX\_FUNCTION\_ARG directive, 275  
 SQLITE\_MAX\_LENGTH directive, 276  
 SQLITE\_MAX\_LIKE\_PATTERN\_LENGTH directive, 276  
 SQLITE\_MAX\_PAGE\_COUNT directive, 276  
 SQLITE\_MAX\_PAGE\_SIZE directive, 277  
 SQLITE\_MAX\_SQL\_LENGTH directive, 277  
 SQLITE\_MAX\_TRIGGER\_DEPTH directive, 277  
 SQLITE\_MAX\_VARIABLE\_NUMBER directive, 277  
 SQLITE\_MEMDEBUB directive, 281  
 SQLITE\_MISMATCH return code, 147  
 SQLITE\_MISUSE return code, 147  
 SQLITE\_NOLFS return code, 147  
 SQLITE\_NOMEM return code, 147, 151  
 SQLITE\_NOTADB return code, 147  
 SQLITE\_OK return code, 146, 224  
 SQLITE\_OMIT\_ANALYZE directive, 285  
 SQLITE\_OMIT\_VIRTUALTABLE directive, 285  
 SQLITE\_OS\_OTHER directive, 278  
 SQLITE\_PERM return code, 147  
 SQLITE\_RANGE return code, 147  
 SQLITE\_READONLY return code, 147  
 SQLITE\_SCHEMA return code, 147, 150  
 SQLITE\_SECURE\_DELETE directive, 279  
 sqlite\_source\_id() function, 372  
 SQLITE\_TEMP\_STORE directive, 280  
 SQLITE\_THREADSafe directive, 279  
 SQLITE\_TOOBIG return code, 147  
 sqlite\_uint64 structure, 411  
 sqlite\_version() function, 372  
 SQLITE\_ZERO\_MALLOC directive, 285  
 sql\_trace pragma, 402  
 square brackets [ ], 30  
 statement parameters  
     binding values, 135–138  
     defined, 133  
     parameter tokens, 133–135

- potential pitfalls, 141–142
- quotation marks and, 134
- security and performance, 138–140
- usage examples, 140
- static extensions, 204, 209–211
- storage
  - initializing, 228
  - mobile devices, 177
- storage classes, 36
- strftime() function, 163–165, 372–375
- string concatenation (||) operator, 33, 347
- strings (text)
  - date and time values, 161
  - defined, 37, 343
  - SQL syntax, 31
  - Unicode encoding and, 117
- Structured Query Language (see SQL)
- subqueries, defined, 76
- substr() function, 375
- subtraction (-) operator, 33, 347
- sum() function, 84, 380
- surrogate keys, 92
- synchronous pragma, 403–404
- system catalogs, 57
- System.Data.SQLite package, 175

## T

- table aliases, 67
- table cursor, 222, 233
- tables, 43
  - (see also virtual tables)
  - altering, 43
  - basic structure, 61
  - column constraints, 38, 313
  - column types, 36–38
  - creating from queries, 42
  - creating with FTS, 169
  - design considerations, 92, 112
  - dropping, 43
  - joining, 63–68, 78, 80
  - keys and, 87–93
  - Normal Forms, 102–106
  - primary keys, 40, 314
  - renaming, 232
  - row modification commands, 46–49
  - structures and relationships, 93–102
  - table constraints, 41, 89, 314
- .tables command, 298
- table\_info pragma, 404

- TCL (Transaction Control Language)
  - about, 34, 51
  - ACID transactions, 51–53
  - additional information, 174
  - save-points, 55–57
  - SQL transactions, 53–55
- TEA (Tcl Extension Architecture), 17, 174
- TEMP keyword, 42
- temp\_store pragma, 405
- temp\_store\_directory pragma, 406
- ternary logic, 31–32
- text (strings)
  - date and time values, 161
  - defined, 37, 343
  - SQL syntax, 31
  - Unicode encoding and, 117
- Third Normal Form, 105
- three valued logic (3VL), 31–32
- time zones, 162
- time() function, 166, 376
- .timeout command, 298
- .timer command, 298
- total() function, 380
- total\_changes() function, 376
- Transaction Control Language (see TCL)
- TRANSACTION keyword, 53
- transaction processing
  - ACID transactions, 51–53
  - dblist module example, 241
  - save-points, 55–57
  - SQL transactions, 53–55
  - SQLite limitations, 13
- trees
  - adjacency model, 100
  - common operations, 99
  - nested set, 101
- trim() function, 377
- type affinities
  - column types and, 37
  - defined, 37
  - mapping, 38
- typeof() function, 377

## U

- unary operators, 33, 345–346
- UNION ALL operator, 77
- UNION operator, 77
- UNIQUE keyword, 45
- UPDATE command

- constraint resolution clauses, 337
  - syntax, 48, 336–338
  - WHERE clause, 336
- upper() function, 168, 377
- user\_version pragma, 406
- USING condition, 66, 82
- UTC (Coordinated Universal Time), 44, 162
- UTF-16 encoding, 117
- UTF-8 encoding, 117

## V

- VACUUM command, 338–339
- VDBE (Virtual Database Engine), 126
- vdbe\_listing pragma, 407
- vdbe\_trace pragma, 407
- version management, 156
- views, creating and dropping, 43
- Virtual Database Engine (VDBE), 126
- virtual table API, 220–224
- virtual tables
  - categories of, 218
  - creating, 43, 246
  - dblist module example, 239
  - defined, 217

## W

- weblog module example
  - about, 246
  - create and connect, 248–249
  - disconnect and destroy, 249
  - filter, 252–254
  - open and close, 250–252
  - registering module, 259
  - rows and columns, 254–259
  - table functions, 250
  - usage example, 259–262
- webserver log analysis, 219
- WHERE clause, DELETE command, 321
- WHERE clause, SELECT command
  - functionality, 50, 63, 68, 334
  - usage examples, 83
- .width command, 298
- wildcards, 71
- writable\_schema pragma, 407

## X

- xBegin() function, 223, 241

- xBestIndex() function, 222, 230, 235, 263–266
- xClose() function, 223, 233
- xColumn() function, 223, 237, 254
- xCommit() function, 223, 242
- xConnect() function, 222, 225
- xCreate() function, 221, 224
- xDestroy() function, 222, 229
- xDisconnect() function, 222, 229
- xEOF() function, 223, 237
- xFilter() function, 223, 235, 266–268
- xFindFunction() function, 222, 231
- xNext() function, 223, 237
- xOpen() function, 223, 226, 233
- xRename() function, 222, 226, 232
- xRollback() function, 223, 242
- xRowid() function, 223, 237
- xSync() function, 223, 241
- xUpdate() function, 222, 239

## Y

- YYSTACKDEPTH directive, 273
- YYTRACKMAXSTACKDEPTH directive, 284

## Z

- zeroblob() function, 378



## About the Author

---

Jay Kreibich is a professional software engineer who has always been interested in how people process and understand information. He is currently working for Volition, Inc., a software studio that specializes in open-world video games. He lives on a small farm in central Illinois with his wife and two sons, where he enjoys reading, photography, and tinkering.

## Colophon

---

The animal on the cover of *Using SQLite* is a great white heron (*Ardea herodias occidentalis*), a subspecies of the great blue heron. Long thought to be a separate species (a point still debated by some avian experts), it differs in that it has a longer bill, shorter plumes at the base of the head, and of course, all-white feathers. To add to the confusion, the great white egret has also been nicknamed great white heron—however, the egret’s legs are black instead of yellow-brown, and it lacks head plumes. Great white herons generally live near salt water, in the wetlands of the Florida Keys and the Caribbean. The main species also ranges throughout Mexico, Central America, and even Canada.

Fish make up the majority of a great white heron’s diet, though it is opportunistic and will also eat frogs, lizards, birds, small mammals, crustaceans, and aquatic insects. The heron mostly feeds in the morning and at dusk, when fish are most active. Equipped with long legs, the bird wades through the water and stands motionless until it sees something come within striking distance. It then snatches up the prey in its sharp bill, and swallows it whole. On occasion, herons have been known to choke on their meal if it is too large.

Though great white herons are solitary hunters, they gather in large colonies for breeding season, with anywhere from 5 to 500 nests. Males choose and defend a nesting spot, and put on noisy displays to attract females. The birds have one mate per year, and the male and female take turns incubating their clutch. After the eggs hatch, responsibility is still shared; both parents will eat up to four times as much food as normal, and regurgitate it for their chicks.

Great blue and great white herons range from 36–55 inches tall, with a wingspan of 66–79 inches. Accordingly, as adults, they have few natural predators due to their size. They’ve frustrated encroaching human civilization with their habit of helping themselves to carefully stocked fish ponds.

The cover image is from Cassell’s *Natural History*. The cover font is Adobe ITC Garamond. The text font is Linotype Birka; the heading font is Adobe Myriad Condensed; and the code font is LucasFont’s TheSansMonoCondensed.

